

Key Features

High Power with Small Size for Space Saving

Excellent Long Term Stability

Complete Flameproof Construction

Controlled Temperature Capability

Solvent Resistant Coat and Code

Special Lead Formations Possible

Type ROX Series

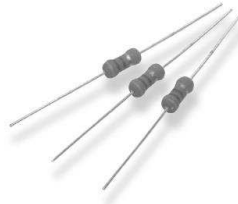

The resistive element comprises a metal oxide film deposited on a ceramic former. The element is protected by a flameproof coating which will withstand overload conditions without flame or mechanical damage. They are recommended for use in applications such as line protection etc

Characteristics – Electrical

Type	Rated Power @ 70°C	Max. Working Voltage	Max. Overload Voltage	Dielectric Withstand Voltage	Resistance Range Ω	Operating Temp. Range	
Normal Size	ROX025	0.25W	250V	400V	250V	0.3 ~ 50K	-55~130°C
	ROX05	0.5W	250V	400V	250V	0.3 ~ 50K	
	ROX1	1W	350V	600V	350V	0.1 ~ 50K	
	ROX2	2W	350V	600V	350V	0.1 ~ 50K	-55~200°C
	ROX3	3W	500V	800V	500V	5.0 ~ 100K	
	ROX5	5W	750V	1000V	750V	5.0 ~ 150K	
	ROX7	7W	750V	1000V	750V	20 ~ 150K	
	ROX8	8W	750V	1000V	750V	30 ~ 200K	
	ROX9	9W	750V	1000V	750V	50 ~ 200K	
Small Size	ROX05S	0.5W	250V	400V	250V	0.3 ~ 50K	-55~130°C
	ROX1S	1W	350V	600V	350V	0.3 ~ 1M0	
	ROX2S	2W	350V	600V	350V	0.3 ~ 1M0	
	ROX3S	3W	350V	600V	350V	0.3 ~ 1M0	-55~200°C
	ROX4S	4W	500V	800V	500V	5.0 ~ 100K	
	ROX5SS	5W	500V	800V	500V	5.0 ~ 100K	
	ROX5S	5W	500V	800V	500V	5.0 ~ 150K	

Resistors shall have a rated direct-current (DC) continuous working voltage or an approximate sine-wave root-mean-square (RMS) alternating-current (AC) continuous working voltage at commercial line frequency and waveform corresponding to the power rating , as determined from the following formula :

$$RCWV = \sqrt{P \times R}$$

Where : RCWV = Rated DC or RMS AC continuous working voltage at commercial-line frequency and waveform (volt)

P = Power Rating (watt)

R = Nominal Resistance (ohm)

Rated Voltage = RCWV or Max. Working Voltage, whichever is smaller



Environmental Characteristics

Characteristics	Specification	Test Methods (JIS C 5201-1)	
DC. Resistance	Must be within the specified tolerance	5.1 The limit of error of measuring apparatus shall not exceed allowable range or 5% of resistance tolerance	
Temperature Coefficient	Range Ω	5.2 Natural resistance change per temp. degree centigrade. $\frac{R_2 - R_1}{R_1(t_2 - t_1)} \times 10^6 \text{ (PPM/}^\circ\text{C)}$ R ₁ : Resistance value at room temperature (t ₁) R ₂ : Resistance value at room temp. plus 100 °C (t ₂)	
	0.1 Ω ~ 12 Ω		± 200
	12.1 Ω ~ 100K		± 350
	101K ~ 1M		-700
	1.1M ~ 10M		-1500
Short time overload	Resistance change rate is Normal Size : $\pm (1\% + 0.05\Omega)$ Max. Small Size : $\pm (2\% + 0.05\Omega)$ Max. with no evidence of mechanical damage	5.5 Permanent resistance change after the application of a potential of 2.5 times RCWV or the max. overload voltage respectively specified in the above list, whichever less for 5 seconds	
Dielectric Withstanding Voltage	No evidence of flashover mechanical damage, arcing or insulation break down	5.7 Resistors shall be clamped in the trough of a 90° metallic V-block and shall be tested at AC potential respectively specified in the electrical characteristics table for 60 + 10/ -0 seconds	
Terminal Strength	No Evidence of mechanical damage	6.1 Direct load: Resistance to a 2.5 kgs direct load for 10 secs. in the direction of the longitudinal axis of the terminal leads Twist test: Terminal leads shall be bent through 90° at point of about 6mm from the body of the resistor and shall be rotated through 360° about the original axis of the bent terminal in alternating direction for a total of 3 rotations.	
Resistance to soldering heat	Resistance change rate is: $\pm (1\% + 0.05\Omega)$ Max. with no evidence of mechanical damage	6.4 Permanent resistance change when leads immersed to 3.2 mm to 4.8 mm from the body in 350°C \pm 10 °C solder for 3 \pm 0.5 seconds	
Solderability	95 % coverage Min.	6.5 The area covered with a new , smooth, clean , shiny and continuous surface free from concentrated pinholes. Test temp. of solder: 245°C \pm 3°C Dwell time in solder : 2 ~ 3 seconds	

Environmental Characteristics (continued)

Characteristics	Specification	Test Methods (JIS C 5201-1)															
Resistance to Solvent	No deterioration of protective coatings and marking	6.9 Specimens shall be immersed in a bath of trichroethane completely for 3 minutes with ultrasonic															
Temperature cycling	Resistance change rate is: ± (2% + 0.05Ω) Max. with no evidence of mechanical damage	7.4 Resistance change after continuous 5 cycles for duty shown below:															
		<table border="1"> <thead> <tr> <th>Step</th> <th>Temp.</th> <th>Time</th> </tr> </thead> <tbody> <tr> <td>1</td> <td>-55±3°C</td> <td>30 mins</td> </tr> <tr> <td>2</td> <td>Room Temp</td> <td>10~15 mins</td> </tr> <tr> <td>3</td> <td>155±2°C</td> <td>30 mins</td> </tr> <tr> <td>4</td> <td>Room Temp</td> <td>10~15 mins</td> </tr> </tbody> </table>	Step	Temp.	Time	1	-55±3°C	30 mins	2	Room Temp	10~15 mins	3	155±2°C	30 mins	4	Room Temp	10~15 mins
		Step	Temp.	Time													
		1	-55±3°C	30 mins													
		2	Room Temp	10~15 mins													
3	155±2°C	30 mins															
4	Room Temp	10~15 mins															
Load life in humidity	<table border="1"> <thead> <tr> <th>Resistance Value</th> <th>ΔR/R</th> </tr> </thead> <tbody> <tr> <td>Less than 100KΩ</td> <td>± 5 %</td> </tr> <tr> <td>100KΩ or more</td> <td>± 10 %</td> </tr> </tbody> </table>	Resistance Value	ΔR/R	Less than 100KΩ	± 5 %	100KΩ or more	± 10 %	7.9 Resistance change after 1,000 hours operating at RCWV with duty cycle of (1.5 hours "on", 0.5 hour "off") in a humidity test chamber controlled at 40 °C ± 2 °C and 90 to 95 % relative humidity									
	Resistance Value	ΔR/R															
	Less than 100KΩ	± 5 %															
100KΩ or more	± 10 %																
Load life	<table border="1"> <thead> <tr> <th>Resistance Value</th> <th>ΔR/R</th> </tr> </thead> <tbody> <tr> <td>Less than 100KΩ</td> <td>± 5 %</td> </tr> <tr> <td>100KΩ or more</td> <td>± 10 %</td> </tr> </tbody> </table>	Resistance Value	ΔR/R	Less than 100KΩ	± 5 %	100KΩ or more	± 10 %	7.10 Permanent resistance change after 1,000 hours operating at RCWV with duty cycle of (1.5 hours "on", 0.5 hour "off") at 70°C ± 2°C ambient									
	Resistance Value	ΔR/R															
	Less than 100KΩ	± 5 %															
100KΩ or more	± 10 %																
Pulse overload	Resistance change rate is: Normal Size : ± (2% + 0.05Ω) Max. Small Size : ± (5% + 0.05Ω) Max. with no evidence of mechanical damage	5.8 Resistance change after 10,000 cycles (1 second "on", 25 seconds "off") at 4 times RCWV or the max. pulse overload voltage															

Derating:

In ambient temperatures greater than 70°C the load shall de-rate as shown in the graph below:

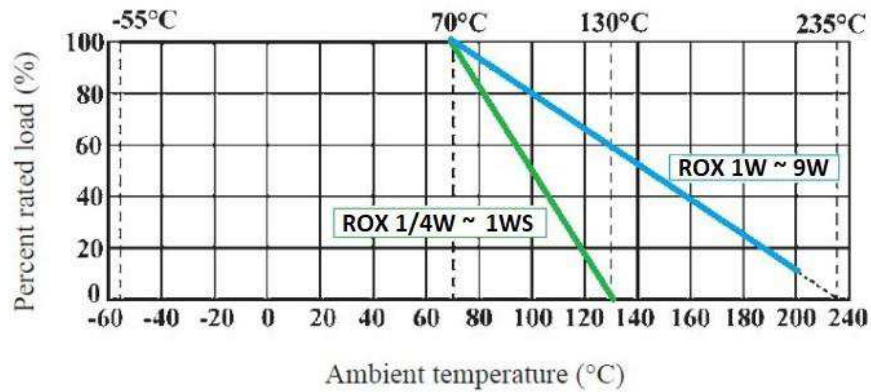

Construction:



No.	Name	Material
1	Basic Body	Rod Type Ceramics
2	Resistance Film	0.1Ω ≤ R ≤ 12Ω : CNP film For All Wattage
		12.1Ω ≤ R ≤ 100KΩ : Metal oxide film For 1/2W-S, 1/4W
		R > 100KΩ : Carbon film For 1/2W, 1W-S
		12.1Ω ≤ R ≤ 120KΩ : Metal oxide film For 1W, 2W-S, 2W, 3W-S, 3W, 4W-S, 5W-SS
		R > 120KΩ : Carbon film (For 5W, 5W-S)
		12.1Ω ≤ R ≤ 150KΩ : Metal oxide film For 7W, 8W, 9W
		R > 150KΩ : Carbon film
		12.1Ω ≤ R ≤ 180KΩ : Metal oxide film (For 7W, 8W, 9W)
3	End Cap	Steel (Tin plated iron surface)
4	Lead Wire	Annealed copper wire coated with tin
5	Joint	By welding
6	Coating	Normal size --Insulated & Non-Flame Paint (Color : Gray) Small size --Insulated & Non-Flame Paint (Color : Sea-Blue)
7	Color Code	Non-Flame epoxy resin

Dimensions:



Type	Dimensions (MM)				
	D (max.)	L (max.)	d ±0.05	H ±3	
Normal Size	ROX025	2.5	7.5	0.54	28
	ROX05	3.5	10	0.70	28
	ROX1	5	12	0.70	25
	ROX2	5.5	16	0.70	28
	ROX3	6.5	17.5	0.75	28
	ROX5	8.5	26	0.75	38
	ROX7	8.5	32	0.75	38
	ROX8	8.5	41	0.75	38
	ROX9	8.5	54	0.75	38
Small Size	ROX05S	2.5	7.5	0.54	28
	ROX1S	3.5	10	0.70	28
	ROX2S	5	12	0.70	25
	ROX3S	5.5	16	0.70	28
	ROX4S	6.5	17.5	0.75	28
	ROX5SS	6.5	17.5	0.75	28
	ROX5S	8	25	0.75	38

Painting method:

Welding point, terminal and lead wire, is permissible to be exposed without the outer coated cover. The extent should be within 1/2 of the resistor body diameter.

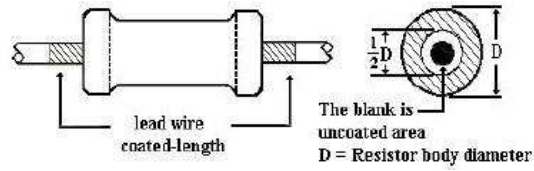

Marking:

For 1/4W, 1/2W, 1W, 2W, 3W, 4W, 5W and all of small size Resistors shall be marked with color coding. colors shall be in accordance with JIS C 0802

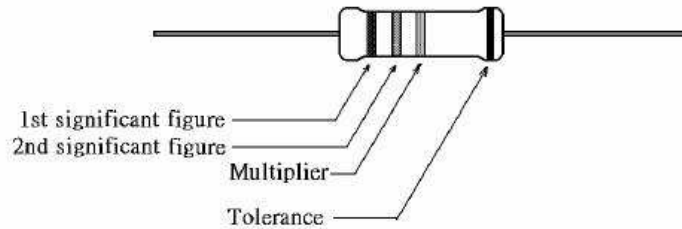

For 7W, 8W, 9W marking shall be in text format:

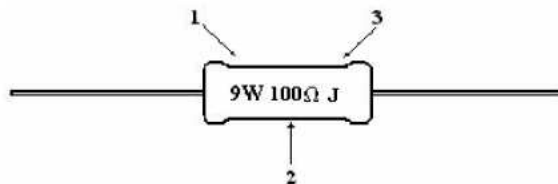

Code description and regulation

1. Wattage rating.
2. Nominal resistance value.
3. Resistance Tolerance.

G: ± 2 %

J: ± 5 %

K: ± 10 %

Packing Specification:

Taping:



	Type	Style	O±1	P	L1-L2	T	Z	R	t	S
Normal Size	ROX025	PT-52	52	5±0.3	1 Max	6±1	1 Max	0	4±1	0.5 max
	ROX05	PT-52	52	5±0.3	1 Max	6±1	1 Max	0	4±1	0.5 max
	ROX1	PT-52	52	5±0.3	1 Max	6±1	1 Max	0	4±1	0.5 max
	ROX2	PT-64	64	10±0.5	1 Max	6±1	1 Max	0	5±1	0.5 max
Small Size	ROX3	PT-64	64	10±0.5	1 Max	6±1	1 Max	0	5±1	0.5 max
	ROX05S	PT-52	52	5±0.3	1 Max	6±1	1 Max	0	4±1	0.5 max
	ROX1S	PT-52	52	5±0.3	1 Max	6±1	1 Max	0	4±1	0.5 max
	ROX2S	PT-52	52	5±0.3	1 Max	6±1	1 Max	0	4±1	0.5 max
	ROX3S	PT-64	64	10±0.5	1 Max	6±1	1 Max	0	5±1	0.5 max
	ROX4S	PT-64	64	10±0.5	1 Max	6±1	1 Max	0	5±1	0.5 max
	ROX5SS	PT-64	64	10±0.5	1 Max	6±1	1 Max	0	5±1	0.5 max

Tape in box packing (Ammopack):



Type	C ± 5	A ± 5	B ± 5	Pack Quantity
ROX025	250	75	96	5000
ROX05	260	85	70	1000
ROX1	262	86	80	1000
ROX2	262	92	108	1000
ROX3	256	92	80	500
ROX05S	250	75	96	5000
ROX1S	260	85	70	1000
ROX2S	262	86	80	1000
ROX3S	262	92	108	1000
ROX4S	256	92	80	500
ROX5SS	256	92	80	500

NB Certain products can be supplied reeled on request.

Plastic cases in box:

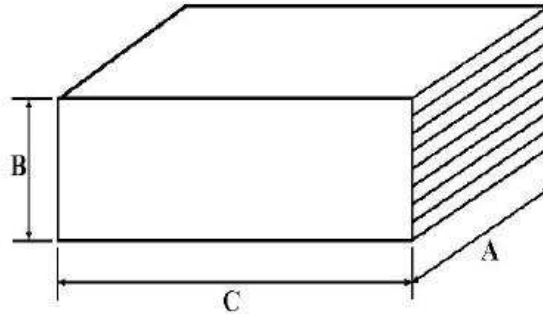

Type	C ±5	A ±5	B ±5	Quantity	
				Plastic Case	Box
ROX5S	36	20	8	100	1000
ROX5	36	20	8	100	1000

Bulk packaging (plastic bag in inner box):

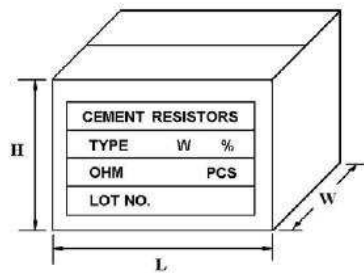

Inner Box of Plastic bag.

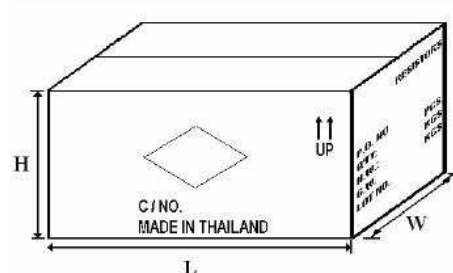

Carton Box

Type	Qty/Bag (Pcs)	Qty/Box (Pcs)	Qty/Carton Pcs	Box size LxWxH (±5)	Carton size LxWxH (±5)	Gross wt ±2 Kgs
ROX7	8	32	1600	150 x 75 x 33	432 x 308 x 215	9.5
ROX8	8	32	1600	150 x 75 x 33	432 x 308 x 215	11.5
ROX9	10	300	1800	200 x 171 x 113	520 x 215 x 250	15



Environment Related Substance

This product complies to EU RoHS directive, EU PAHs directive, EU PFOS directive and Halogen free Ozone layer depleting substances.

Ozone depleting substances are not used in our manufacturing process of this product. This product is not manufactured using Chloro fluorocarbons (CFCs), Hydrochlorofluorocarbons (HCFCs), Hydrobromofluorocarbons (HBFCs) or other ozone depleting substances in any phase of the manufacturing process.

Storage Condition

The performance of these products, including the solderability, is guaranteed for a year from the date of arrival at your company, provided that they remain packed as they were when delivered and stored at a temperature of 25°C ± 10°C and a relative humidity of 60%RH ± 10%RH, chemical and dust free atmosphere

Even within the above guarantee periods, do not store these products in the following conditions. Otherwise, their electrical performance and/or solderability may be deteriorated, and the packaging materials (e.g. taping materials) may be deformed or deteriorated, resulting in mounting failures.

1. In salty air or in air with a high concentration of corrosive gas, such as Cl₂, H₂S, NH₃, SO₂, or NO₂
2. In direct sunlight

How To Order

	ROX	1S	J	100K	
Common Part	Power Rating		Tolerance	Resistance Value	Special Request
ROX – Flame proof power metal oxide film resistor	Normal size	Small size		R33 -0.33Ω	BL * – Pre-formed Leads TR - Reeled
	025 - 1/4W	05S – 1/2W		1R0 - 1Ω	
	05 – 1/2W	1S – 1W		10R - 10Ω	
	1 – 1W	2S – 2W	G – 2%	100R - 100Ω	
	2 – 2W	3S – 3W	J – 5%	1K0 – 1KΩ	
	3 – 3W	4S – 4W		(1000Ω)	
	5 – 5W	5SS – 5W		100K – 100KΩ	
	7 – 7W	5S – 5W		(100,000Ω)	
	8 – 8W				
	9 – 9W				