

# BEST PRACTICES FOR IDC MAGNET WIRE TERMINATION

A QUICK GUIDE TO ECONOMIC  
TOOLING SOLUTIONS

# EARLY COLLABORATION

---

We provide custom tooling solutions that directly interface with your product. Early and consistent communication is key for the most reliable and economical solutions.

For additional information, please go to [tooling.te.com](http://tooling.te.com) and visit our “Magnet Wire Equipment” page.

## Please Contact Us:

**Americas**

**Asia / Pacific**

Application Tooling

P.O. Box 3608

Harrisburg, PA 17105-3608, USA

[ToolingSales@te.com](mailto:ToolingSales@te.com)

717.810.2082

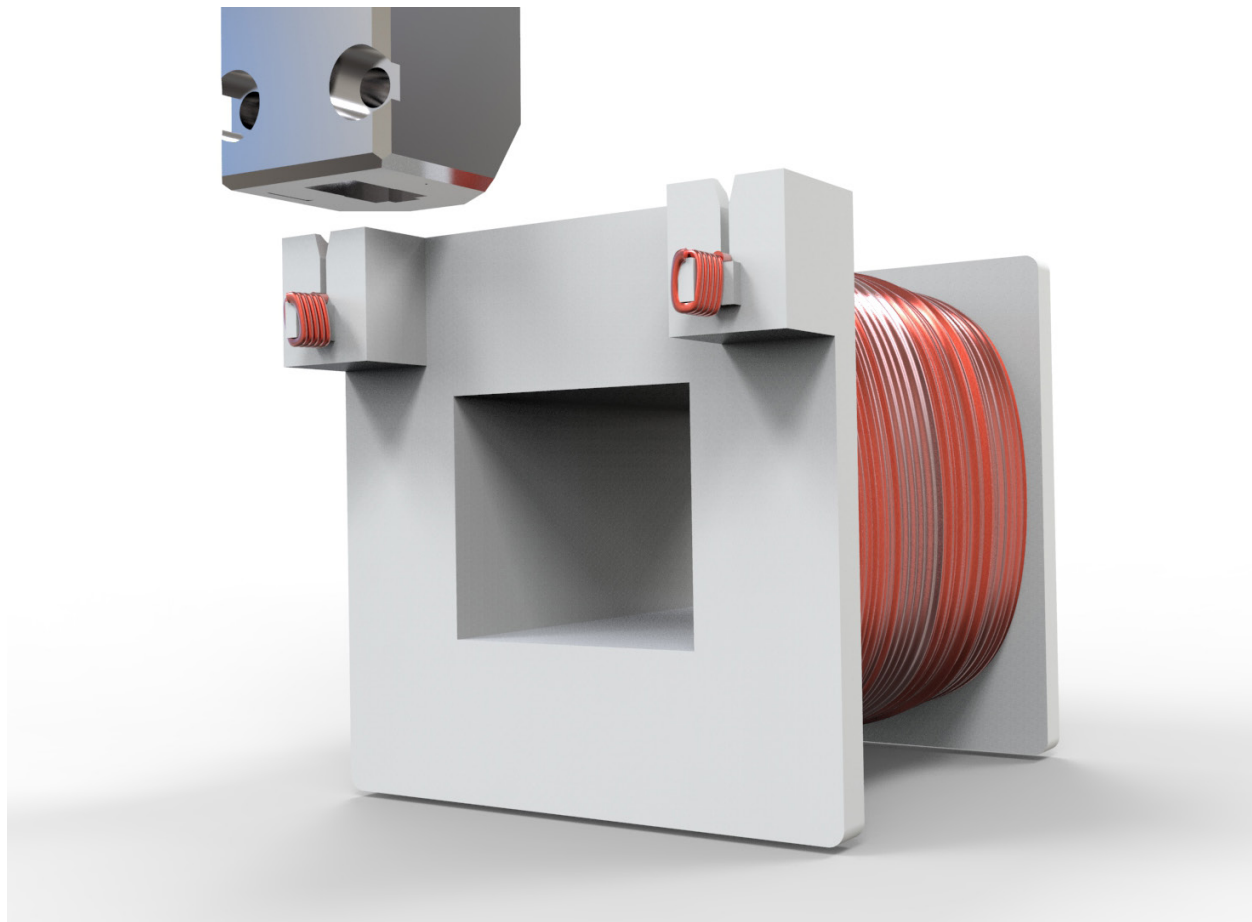

# OUR DESIGN PROCESS

---

Once you have spoken with a TE Terminal Application Specialist at TE Connectivity (TE), we gather some information about your product and a quote can be made.

We will work with you to create the appropriate application tooling specifically for your product. The following guidelines describe various areas that can create design challenges for your product. A solution can always be found, but it will be more efficient and economical to stay within the “suitable” concepts, rather than risking extra time and expense on the “challenging” options.

Clear communication is key to confirm that your expectations are met with the correct application tooling.

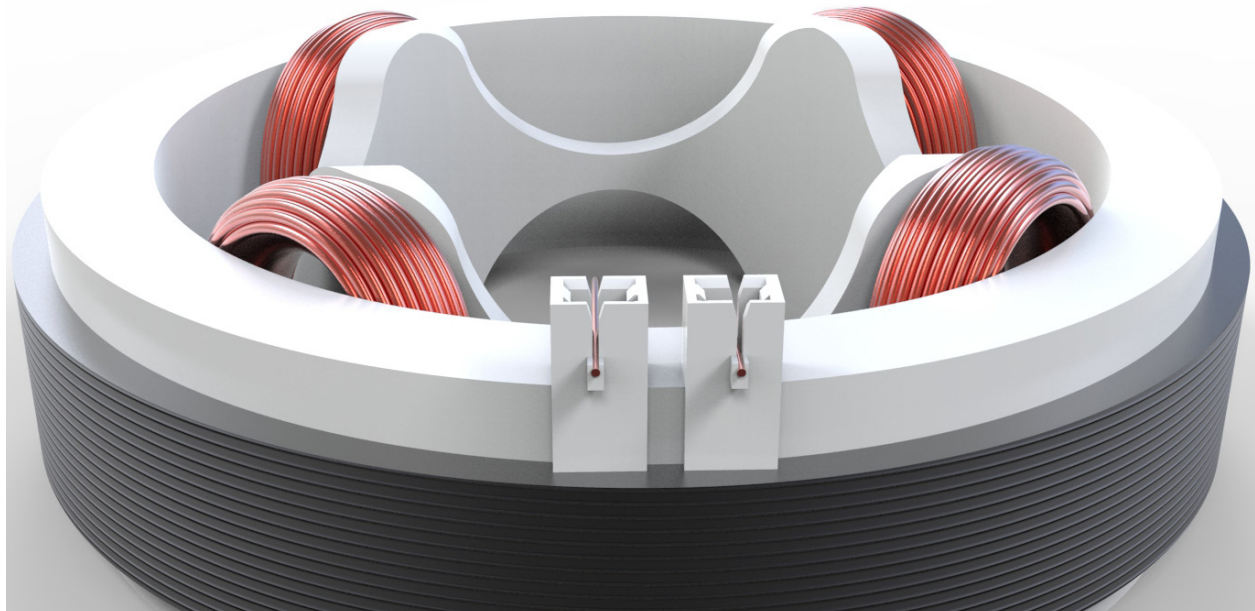

# THE MAG-MATE TERMINAL INTERCONNECTION SYSTEM

The MAG-MATE, Mini MAG-MATE, and SIAMEZE terminal products can be used on a variety of applications. Common examples include: small motors, relays, transformers, bobbin coils, shaded pole-motors, solenoids, and motor protectors with a thermal cutout.

This reliable system provides insulation displacement termination for unstripped copper and aluminum magnet wires. TE Connectivity is capable of producing creative solutions for all aspects of magnet wire termination for a variety of wires and production levels.

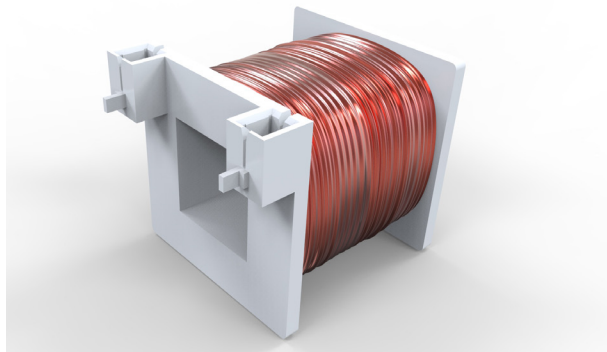
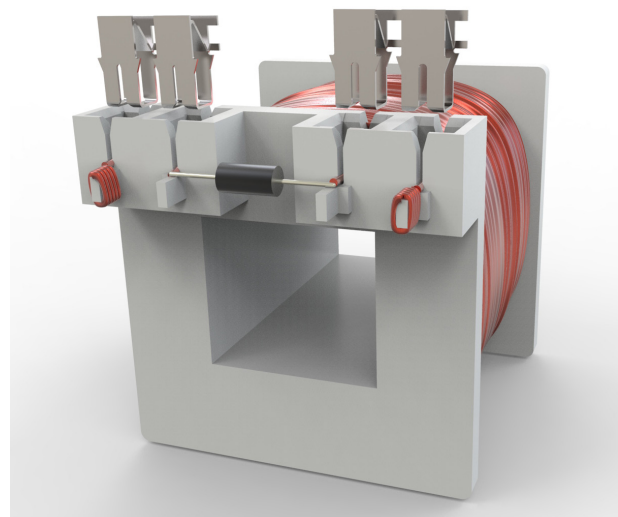
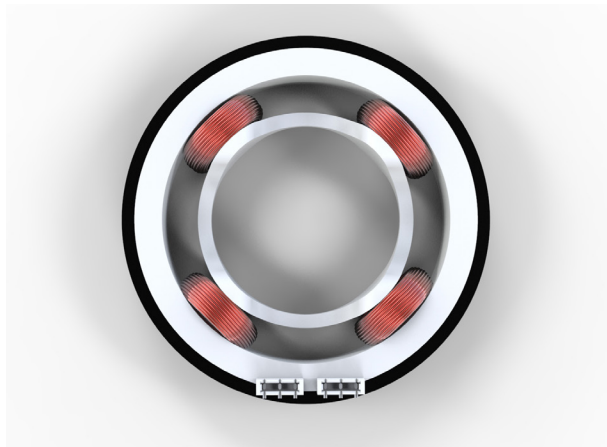

Stators and bobbins are common products (top left, bottom left) but more creative solutions that include diode insertion (right) can be produced through our system that allows for multiple terminals to be inserted while still connected (bussed/commened).

# HOW OUR SYSTEM WORKS

A cavity within customer product will house the inserted terminal, and should contain features for wire and terminal support, as described in TE Connectivity application specifications.

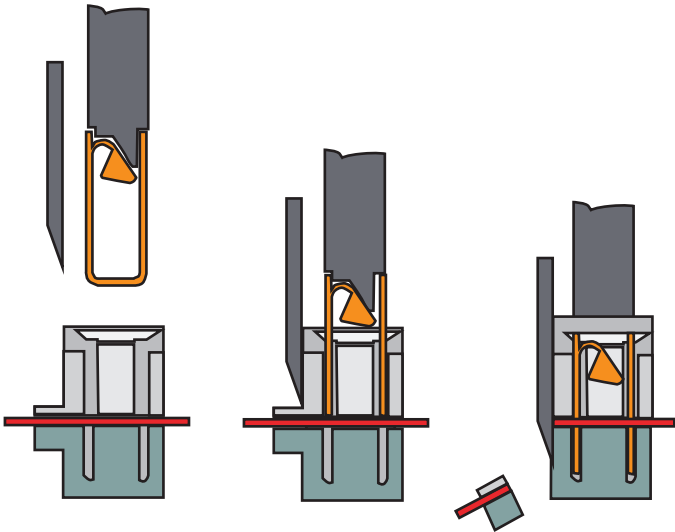

### MAG-MATE Terminal:

Unstripped wire is inserted in the cavity through the slot, and makes contact with the bottom of the slot and top of the anvil.

The terminal is pushed through the inserter “tube” and positioned in the cavity by the insertion finger.

As the terminal is inserted into the cavity, the insulation film on the wire is stripped by the IDC slot and stripping shoulders, while the locking bars on the terminal secure the terminal within the cavity. The post trim blade cuts the wire support block and scrap wire as the terminal is fully inserted into the cavity.

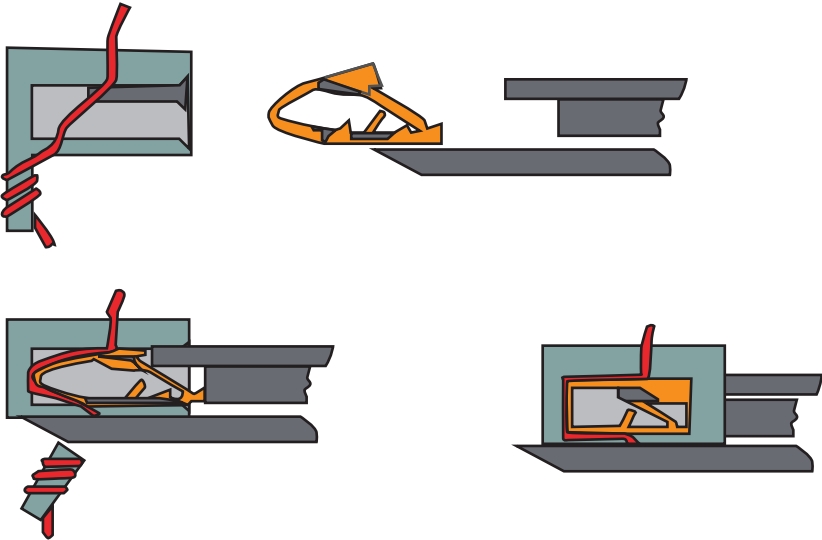

### Mini MAG-MATE Terminal:

A smaller interconnection system is design for extremely small wire diameters. This terminal uses a unique cam action to provide the IDC contact without applying tension to the magnet wire.

## Standard MAG-MATE Terminals



The standard process for MAG-MATE terminals has specialized tooling to create an excellent connection and efficient removal of scrap wire.

## Standard SIAMEZE Terminals



For SIAMEZE terminals, the insertion process is quite similar to the MAG-MATE terminal process, except with different specialized tooling. Please review the application specifications for SIAMEZE terminal insertion for the appropriate cavity geometry.



## SIAMEZE Terminals With Lead Lok Terminals

One of the advantages of the SIAMEZE terminal is the ability to terminate both the magnet wire and lead wire in the same process. The SIAMEZE terminal is inserted with the standard process, and a secondary insertion with the appropriate tooling applies the Lead Lok terminal.

# ADVANTAGES TO THE SYSTEM

Because terminals and tooling for this system are all through TE Connectivity, we provide an experience encompassing all of your needs for magnet wire termination through our collaboration and knowledge gained through years of experience.

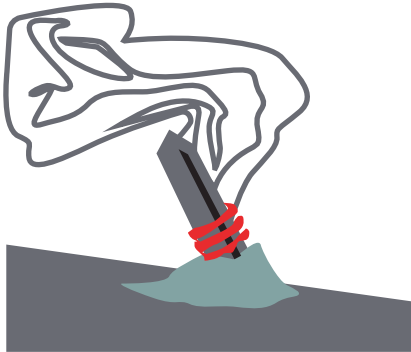

With the MAG-MATE, Mini MAG-MATE, and SIAMEZE terminal applications, there is no use of solder, increasing productivity, reducing environmental impact, increasing quality of the finished product, and improving employee safety.



Left: Arbor press for low volume; Right: Vertical Machine-Single Terminal for larger volumes; Bottom: Module for integration into high volume production lines.

This system can be used for various wire sizes and production levels, with Mini MAG-MATE terminals applying to wire sizes 52-30 AWG (0.02 to 0.250 mm), MAG-MATE terminals connecting to wires sizes 34-12 AWG (0.16 to 2.05mm), and SIAMEZE terminals for wires of 36-12 AWG (0.127 To 2.05 Mm). Our tooling options range from low volume or repair and prototyping to automated and semi-automated solutions for processing millions of parts a year.

Our tooling solutions provide the option of “On-the-fly Insertion,” which allows for an automatic change from single to multiple (bussed/commoned) terminals to be inserted in a single stroke.

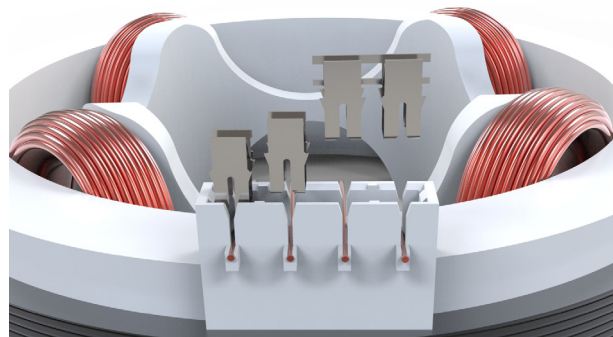

# RECOMMENDATIONS

---

This information is to aid early involvement for a customer design. It is not comprehensive, and best results will occur by contacting our team. Following the guidelines outlined in this document will provide the most reliable and economical tooling solution possible for your product. These are not comprehensive, and an Application Tooling specialist at TE Connectivity should always be consulted prior to designing your product around these guidelines.

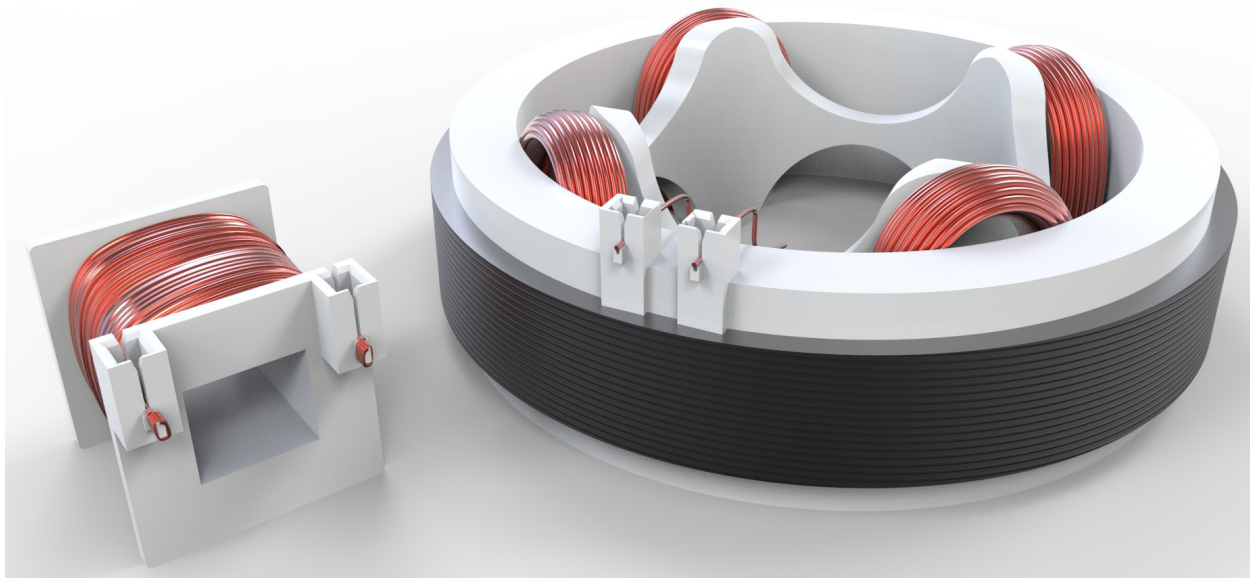

**If any of these guidelines cannot be met, please contact us.  
We always confirm a solution is found.**



# TRIMMING

The wire trimming portion of the insertion process requires several considerations. During terminal insertion, the post trim blade will simultaneously cut the wire support block. The following guidelines will confirm that trimming will be efficient. It is not required to trim the excess wire, which may allow for some additional flexibility in your design. However, wire retention for all parts is necessary for proper termination. Please contact us for more information on options for wire trimming and retention, as there are various solutions that can be tailored to suit your needs.

## Ideal

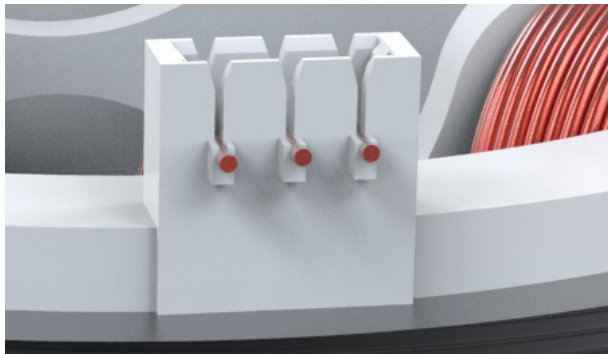

The suitable design for good trimming includes a support block with a cavity slot for the wire according to the application specifications for your selected terminal.

## Unacceptable

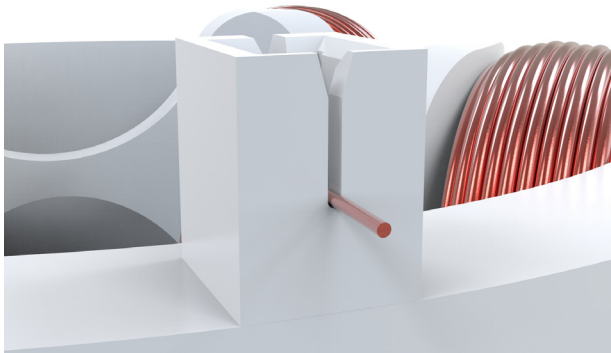

A support block for trim must be included for a clean cut. If a support block cannot be provided, the wire can be left uncut. Tie off posts, often used for bobbins, can serve as the support block as well.

## Challenging

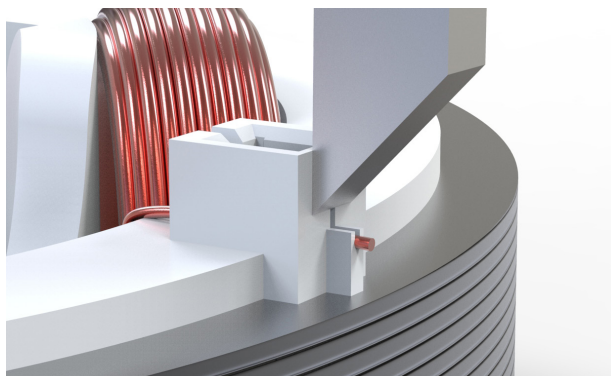

Clearance below and around the support block should allow for the blade to travel past the product to allow for the cleanest cut.

Keeping wire ends short will reduce handling and scrap wire problems. Gravity is typically used for the removal of scrap wire and the wire support. If this is not adequate or possible, it is recommended that it is removed by vacuum or other means provided by the customer. Please note, the scrap from terminal cut-off is collected by a module.

**Acceptable**

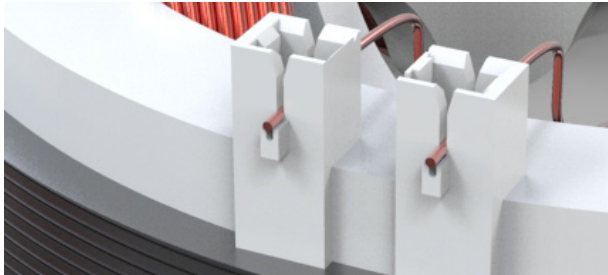

**Challenging**



The wire slot in the cavity cannot be obstructed by the coil windings, and the wire must be able to be placed in the bottom of the wire slot for both entry and exit of the cavity. This will confirm a clean cut and is required for proper termination.

**Acceptable**

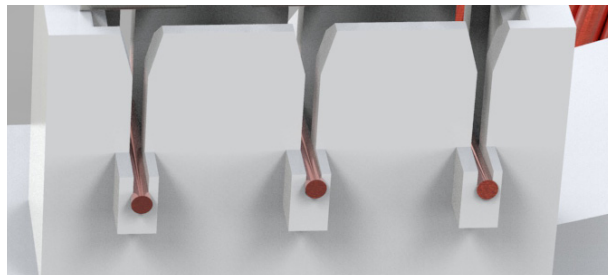

**Unacceptable**

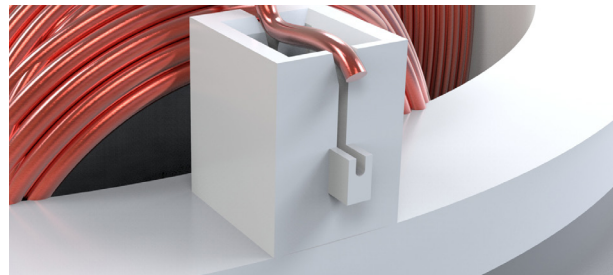

For most terminals, it is suitable for the trim of the wire to occur away from the carrier strip of the terminal (top trim). It is challenging to have the carrier strip adjacent to the trim (bottom trim), because of the required spacing needed for the various cutting components to process the terminal.

**Acceptable**

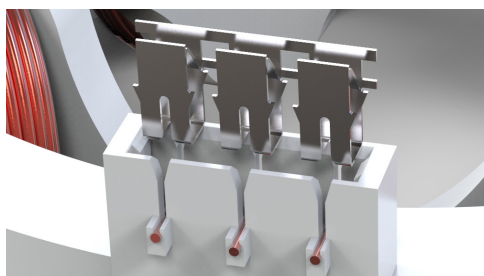

**Challenging**

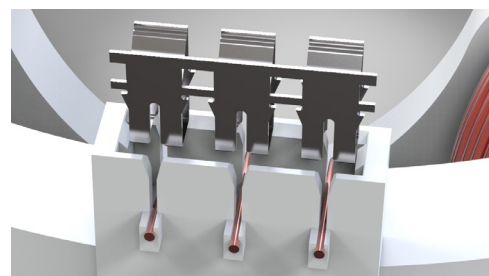

# TOOL CLEARANCE

Cavities should be the highest portion (plane) of the product, leaving adequate clearance for the tooling. This will confirm that there is clearance for the tooling before, during, and after terminal insertion. Otherwise, some geometries may completely prevent terminal insertion, such as the example below. Consider the volume of wound wire on the product as well.

Unacceptable

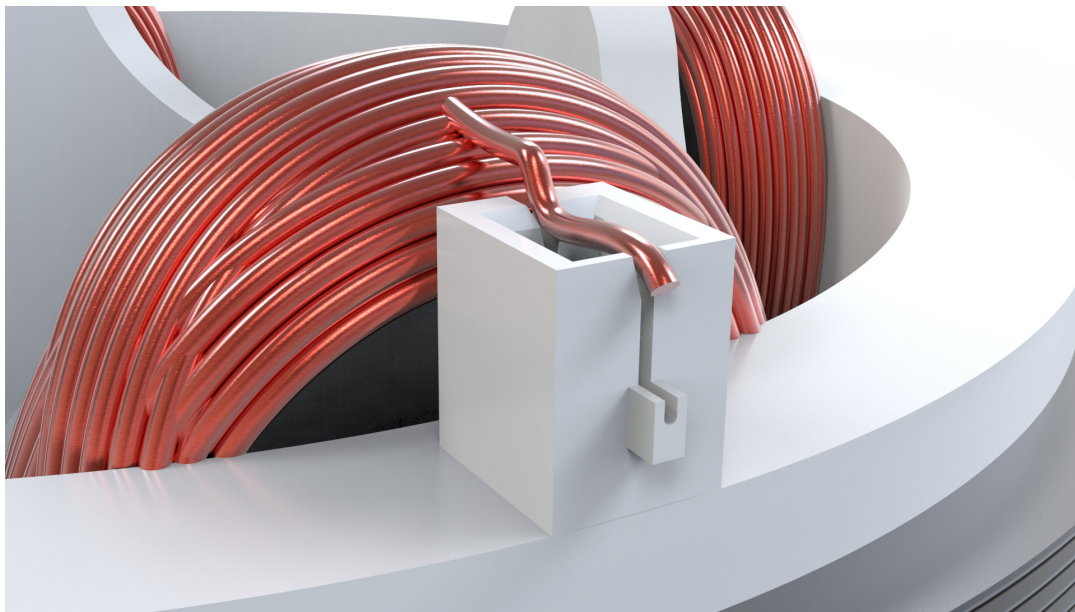

The insertion area should be kept clear for the tooling footprint. The tooling needs to be able to make even contact with the top, flat surface of the cavity in order to properly apply the forces to the cavity and terminal for good insertion.

Acceptable

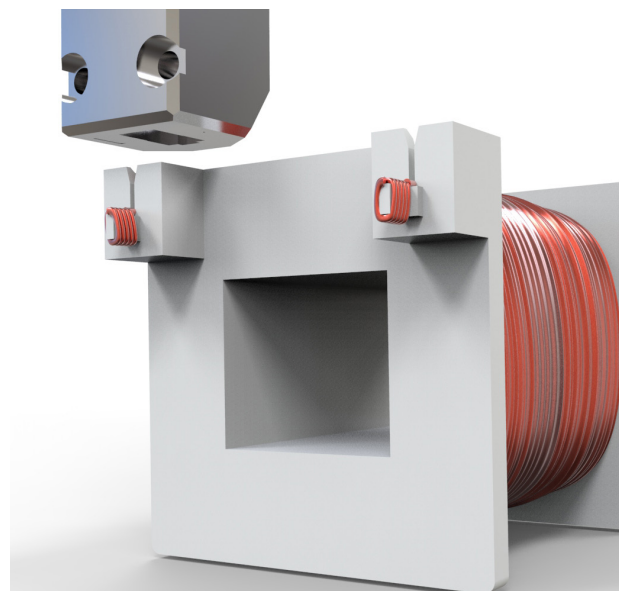

# CAVITIES

Cavities should generally be kept as shallow as allowed by the application specification for the terminal selected with help from our terminal application specialists.

**Acceptable**

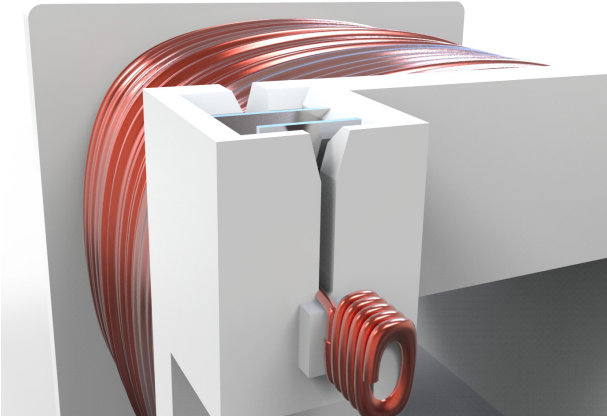

**Challenging**

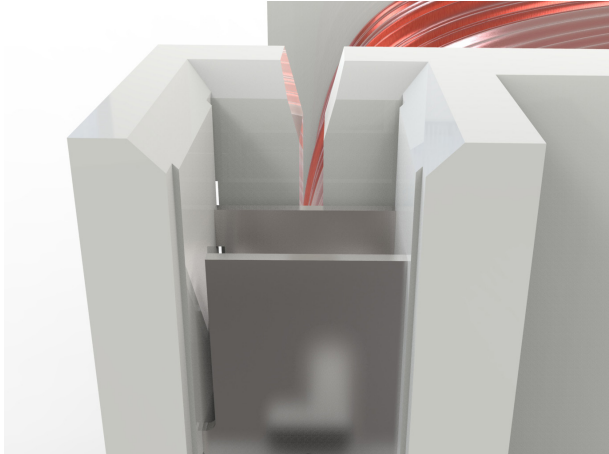

Design of the product should refrain from any locking features on the insertion or cut surfaces of the cavity to confirm that wire can be properly cut without any damage to the product. Protrusions above the cavity will also cause issues with terminal insertion.

**Acceptable**

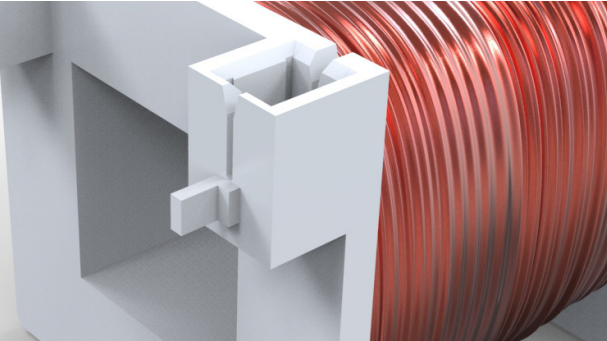

**Challenging**

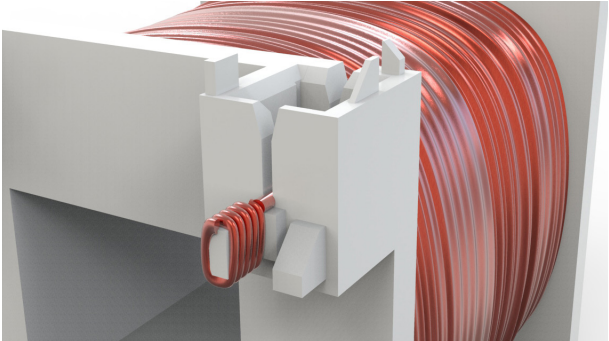

# MULTIPLE INSERTIONS

If your product requires multiple terminals to be inserted into cavities at the same time, it is required that the cavities are spaced center-to-center to match the terminal spacing listed as the “die feed” on the terminal drawing.

**Acceptable**

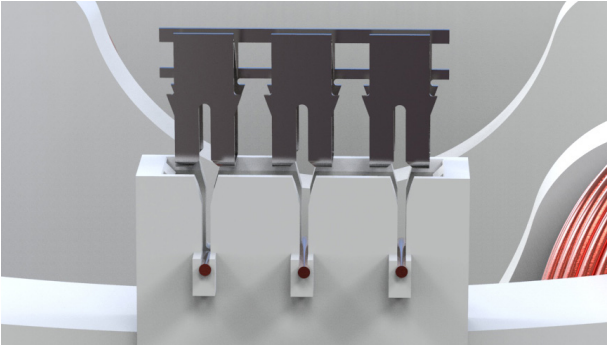

**Unacceptable**

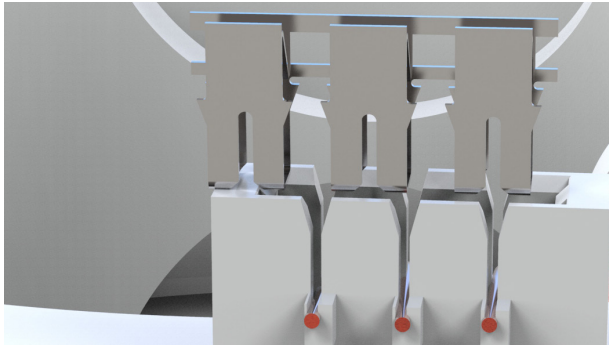

If multiple terminals will be inserted, but will not need to be pressed at once, the cavities can be spaced differently, as they will be separate from the carrier strip prior to insertion (bussed v. single). However, these cavities cannot be brought closer together than the spacing of the terminals on the reel, as this will cause collisions.

**Single Insertions**

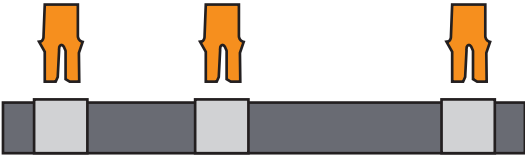

**Both Single and Multiple Insertions**

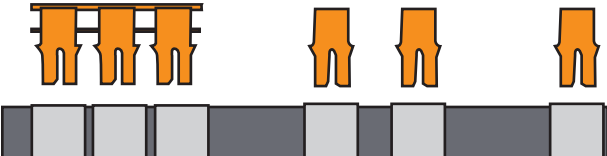

It is often possible to insert combinations of bussed (commoned) and single terminals with the same machine, saving cost and time. These types of applications will need close review by TE Connectivity Application Tooling specialists to confirm that there is no tooling interference.

# CAVITY LOCATION

If the cavities are placed around the circumference of the product, all cavities should have the same distance to the center of the product (radius). Cavity placement should consider fixture movement during the insertion process. It is ideal if cavities are related in location through either rotation or translation, allowing for one type of motion for the positioning of the cavities. This will prevent secondary operations, keeping cost lower and reliability higher

## Ideal



Translate Only

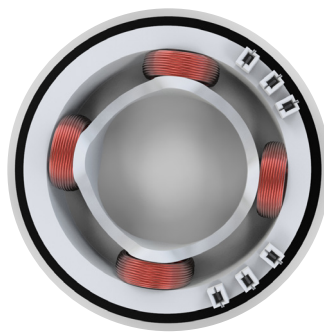

Rotate Only

## Challenging



Cavities should be placed close together to prevent the need for excessive fixture movements, also reducing complexity and cycle time.

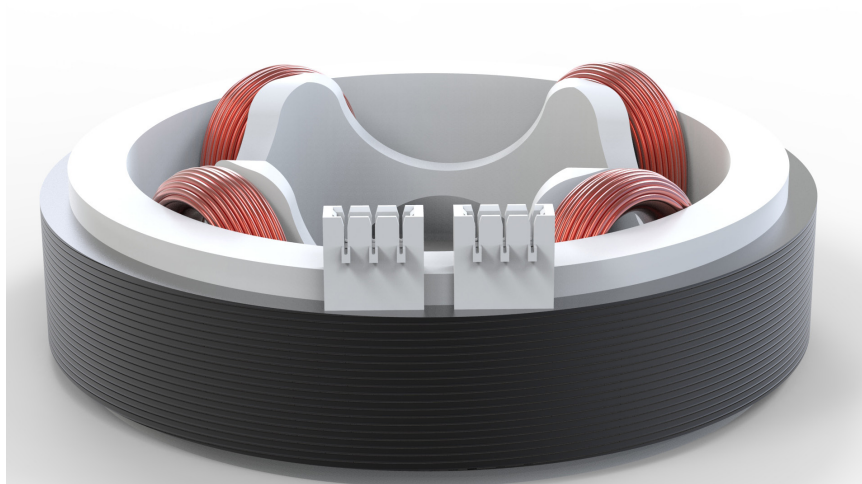

# DISTORTION AND APPLICATION FORCES

Winding forces may distort the molded part. Dimensions for the application should be inspected after winding the wire. Any variation due to winding must be within tolerance.

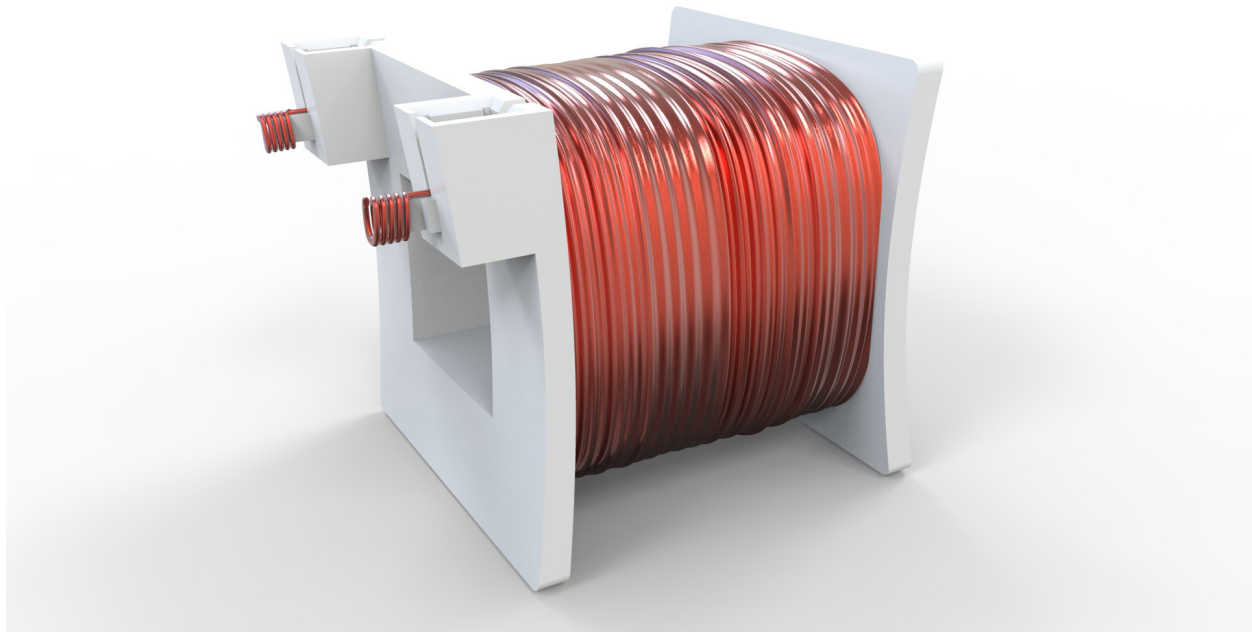

The plastic molding must be able to resist the force of insertion which can be as much as 1112 Newtons. For clarification of material choices and design, please reference the appropriate application specification. Cavity design must allow for support in line with the insertion. The bottom of the cavities must be flat to allow for support during the insertion process.

**Suitable**

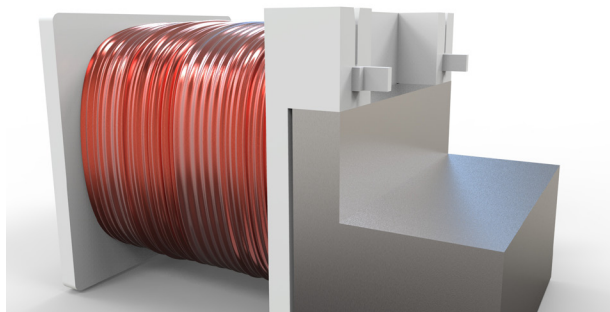

**Challenging**

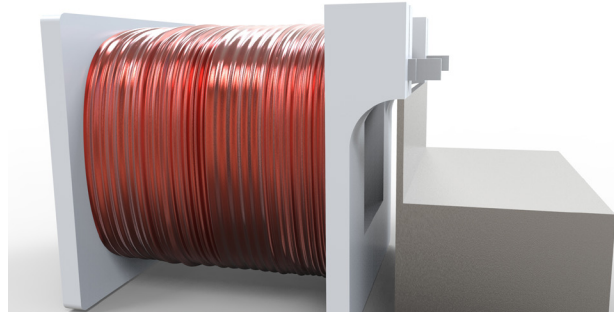

# WIRE TENSION AND SELECTION

## Mini MAG-MATE Terminals

It is important that the wire that is in the cavity is not put under high tension. Due to the nature of thin wire, if it is under tension during terminal insertion, breaking and failure of the connection can occur.

Acceptable

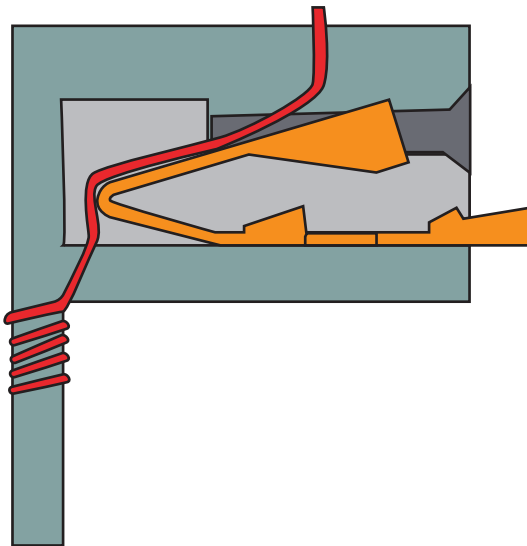

Unacceptable

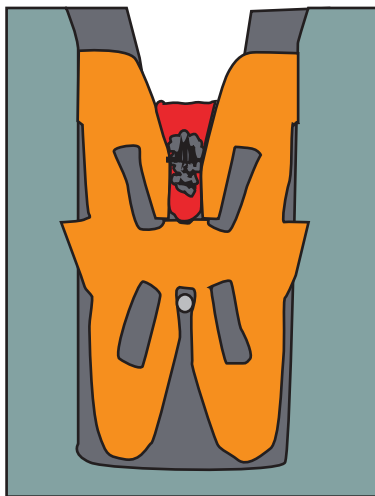
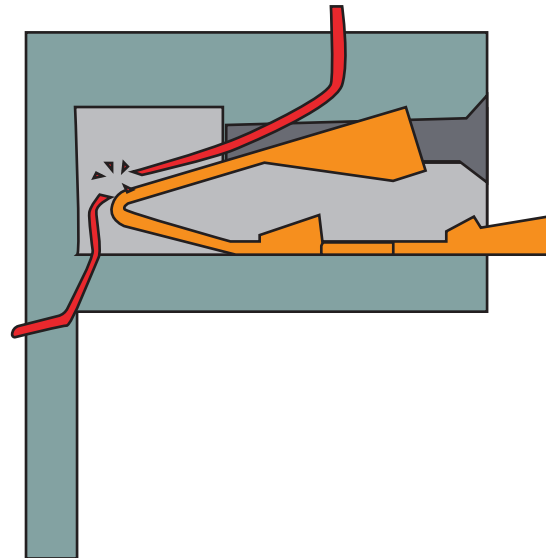

## SIAMEZE Terminals

When using the SIAMEZE with Lead Lok solution, it is imperative that the proper lead wire type is selected according to the appropriate application specification. Damage to the terminal and your product can occur if the proper wire type is not selected.



# WE WORK WITH YOU

---

With so many things to keep in mind, confirming that your product will efficiently and cost effectively interface with TE Connectivity tooling might be daunting. However, our solutions are customized to your needs, and innovative design is at the core of what we do. Do not hesitate to ask us questions, as we are always happy to help.

Whether you need low volumes of prototype parts or require automation to integrate into a cell, we will utilize our resources and experience to create exactly what you need.

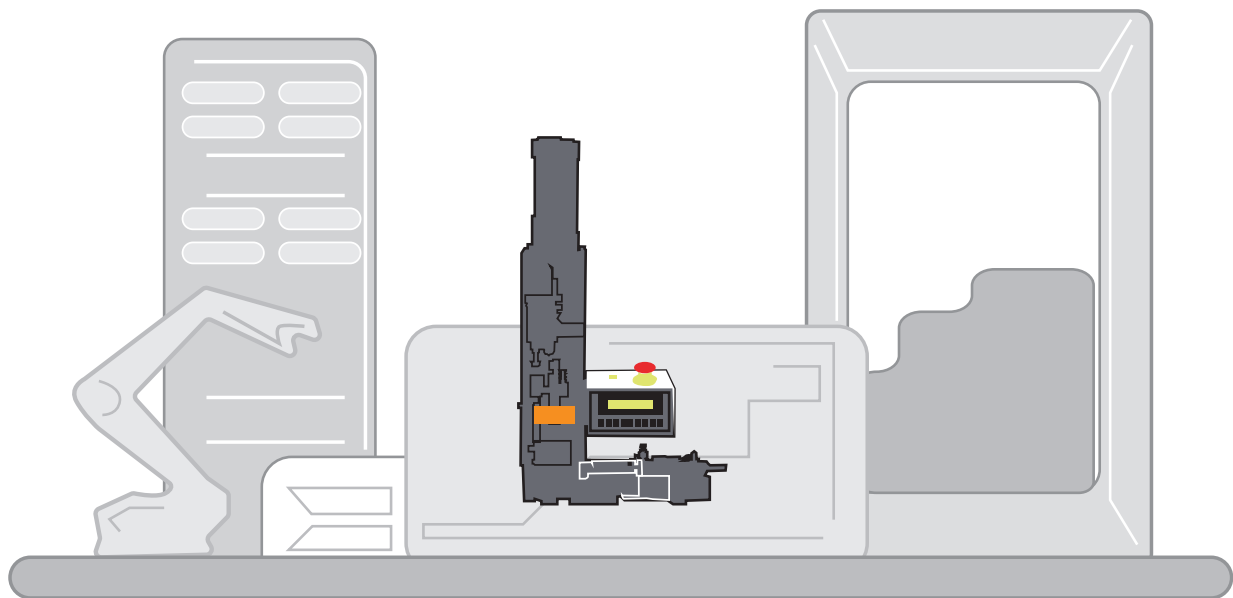
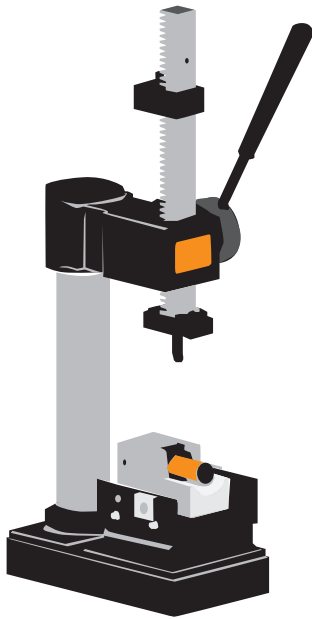







## Let's Connect

To learn more about the right TE tooling for your needs, call us a 717-810-2082 or email [ToolingSales@te.com](mailto:ToolingSales@te.com)



### TE Technical Support Center

USA:	1.800.522.6752	UK:	+44.0800.267666
Canada:	1.800.522.6752	France:	+33.1.34.20.8686
Mexico:	+52.55.11.06.0800	Netherlands:	+31.73.624.6999
Latin/S. America	+54.11.4733.2200	China:	+86.400.820.6015
Germany:	+49.6151.607.1999		

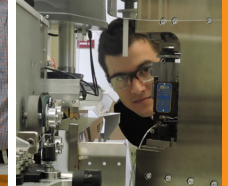
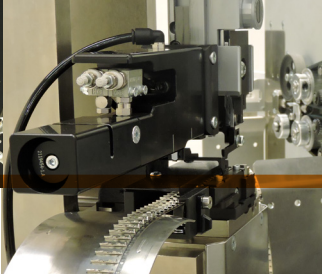
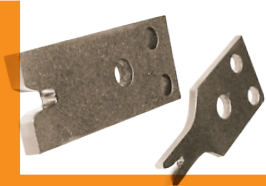

### Time is Money.

In manufacturing downtime can be expensive. That's why TE is constantly working to improve product availability and delivery

rates. With a strong global footprint, short lead times and a strong distribution channel, TE has the equipment and the accessories to keep production online.

To check distributor stock and availability for your tooling needs go to: [www.te.com/commerce/sck/cdi.do](http://www.te.com/commerce/sck/cdi.do)



### Waste Not. Want Not.

Whether its time or scrap, in manufacturing everyone knows that waste costs money. With our on-site certification and consultation services, we can help you:

- Reduce downtime
- Reduce scrap
- Maintain crimp quality
- Improve manufacturing efficiency

Connect with us today to learn more.

- E-mail: [fieldservicesnorthamerica@te.com](mailto:fieldservicesnorthamerica@te.com)
- Phone: **800-722-1111 or 717-986-3434**
- For additional information download catalog #1-1307619-0 from [tooling.te.com](http://tooling.te.com).

### te.com

MAG-MATE, Mini MAG-MATE, SIAMEZE, TE Connectivity, and the TE connectivity (logo) are trademarks.

© 2018 TE Connectivity Ltd. family of companies All Rights Reserved.

2338149-1 08/18 Original