



NON-INCENDIVE Pressure Transducer / Transmitter AST4300

Overview

The AST4300 is a stainless-steel pressure transducer / transmitter for use in hazardous areas. In addition to its rugged construction and best price-to-performance ratio in the industry, the AST4300 is the solution for pressure measurement for a variety of applications.

Benefits

- Class I Div 2 Groups A, B, C, D*
- ATEX / IECEx: Ex ec IIC T4 Gc (Ta = -40°C to 85°C)**
- Class I Zone 2, AEx ec IIC, T4**
- High Strength Stainless Steel Construction
- No Oil, Welds or Internal O-rings
- Wide Operating Temperature
- Pressures from Vacuum to 20,000 PSI
- Low Static and Thermal Errors
- Unparalleled Price and Performance
- Compatible with Wide Variety of Liquids and Gases
- EMI/RFI Protection

Applications

- Refrigeration
- Water Management
- Industrial OEM Equipment
- Oil & Gas Platforms
- Pressure Instrumentation
- Process Control
- Gas Compression & Storage
- Test Stands
- Oxygen Delivery Systems
- Hydrogen Fuel (316L)

*For DIN43650A and Turck Mini-Fast connectors (suffix I and 4 in 16th position of model code.)

**For metal conduit connector (suffix "L," "M," "N," and "P" in 16th position of model code.)

Environmental Data

Ambient Temperature: 25°C (77°F) (Unless otherwise specified)

Operating Ambient	-40 to 80°C (-40 to 176°F)
Storage	-40 to 100°C (-40 to 212°F)

Electromagnetic Compatibility (EMC)

Standard	Description	Test Value
EN55011	Radiated Emissions	Class A, 30-1000 MHz
EN61000-4-2	Electrostatic Discharge Immunity	±8 kV Air Discharge ±4 kV Contact Discharge, VCP, HCP
EN61000-4-3	Radiated Electromagnetic Field Immunity	10V/m, 30-2700 MHz 80% 1kHz AM Modulation
EN61000-4-4	Electrical Fast Transient/Burst Immunity	±0.5 kV, ±1 kV, ±2 kV on DC Mains ±0.5 kV, ±1 kV on I/O Ports
EN61000-4-5	Surge Immunity	±0.5 kV, ±1 kV, on I/O Ports & DC Lines
EN61000-4-6	Conducted immunity	10V rms, 0.15-80 MHz, DC Mains 10V rms, 0.15-80 MHz, I/O Ports 80% 1kHz AM Modulation
EN61000-4-8	Power Frequency Magnetic Field Immunity Test	30 A/m @ (50Hz, 60Hz) 3 orthogonal orientations

Shock, Vibration & Ingress Protection (IP)

Standard	Description	Test Value
EN 60067-2-27	Shock Test	500m/s ² , 6ms, half sine-wave, 6 shocks (3/direction), horizontal and vertical axis, 12 total shocks
EN 60068-2-6	Sinusoidal Vibration	5-25 Hz, 2mm, 25-150 Hz, 50m/s, Sweep rate: 1 octave/min, Duration: 24 hours/axis (48 hours total), horizontal and vertical axis
EN 60068-2-64	Random Vibration	10-2000 Hz, vibration level: 0.0314 (m/s ²) ² /Hz, 24 hrs/axis (48 hrs total), 2 directions: horizontal and vertical
IEC 60068-2-32	Drop Test	Drop of 1 meter to floor made of concrete. Dropped twice on the threaded end and two times perpendicular to the threaded end.
IP-66	Ingress Protection	Dust-tight, protected against powerful water jets

Performance

Ambient Temperature: 25°C (77°F) (Unless otherwise specified)

Parameters	MIN	TYP	MAX	UNITS	NOTES
Accuracy	-0.25		+0.25	%Span	1
Zero Error	-1.0		+1.0	%Span	2
Span Error	-2.0		+2.0	%Span	3
Thermal Error, Zero	-1.5		+1.5	%Span	4
Thermal Error, Span	-1.5		+1.5	%Span	5
Stability (1 year)		±0.25		%Span	
Proof Pressure		2X Rated Pressure		%Span	6
Burst Pressure		5X Rated Pressure or 40,000 (whichever is less)		PSI	7
Compensated Temp. Range		0 - 55° (32 to 132°)		°C (°F)	

Electrical Data

Model	AST4300		
Output	4-20mA	1-5V, 1-6V	0.5-4.5V Ratiometric
Excitation	10-28VDC	10-28VDC	5.0 ± 0.5VDC
Output Impedance	> 10k Ω	< 100 Ω	< 100 Ω
Current Consumption	-	<10mA	<10mA
Output Noise	-	<2mV RMS	<2mV RMS
Output Load	0-800Ω	10k Ω Min.	10k Ω Min.
Reverse Polarity Protection	Yes	Yes	Yes
Bandwidth	DC-250 Hz	DC-1kHz	DC-1kHz

Notes

1. The maximum deviation from a best fit straight line (BFSL) fitted to the output measured over the pressure range at 25°C. Includes all errors due to pressure non-linearity, hysteresis, and non-repeatability. Span is the algebraic difference between full scale output and zero pressure offset.
2. The maximum variation from the ideal offset measured at 25°C.
3. The maximum variation from the ideal full-scale span measured at 25°C.
4. The maximum variation of offset within the compensated temperature range relative to 25°C.
5. The maximum variation of full-scale span within the compensated temperature range relative to 25°C.
6. The maximum pressure that can be safely applied to the product for it to remain in specification once pressure is returned to the operating pressure range.
7. The maximum pressure that can be applied without causing escape of the pressure media.

Dimensions & Electrical Connection

Unless otherwise specified, all dimensions are in inches

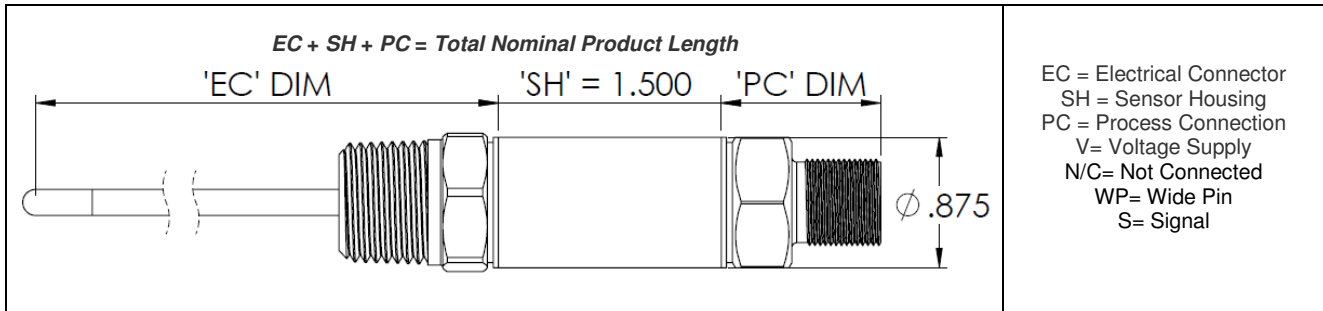

Electrical Connectors Option Codes

Conduit Cable

L 2ft (0.6m)	M 4ft (1.2m)	N 6ft (1.8m)	P 10ft (3m)
------------------------	------------------------	------------------------	-----------------------

Color	3 Wire Voltage	4-20mA
Green	N/C	N/C
Green (-SS only)	Case	Case
Black	GND	-V
Red	+V	+V
White	S	N/C

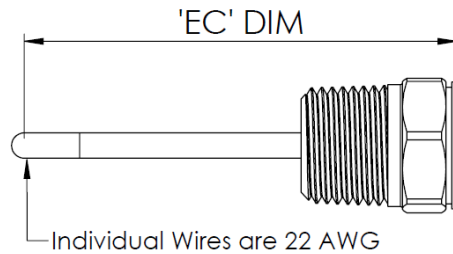

I
DIN 43650A 18.0mm
(Big- DIN)

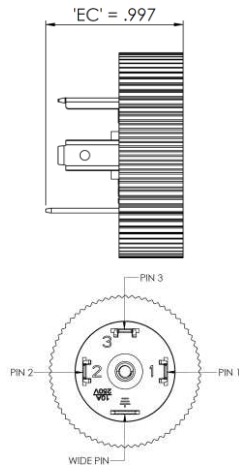

Pin	3 Wire Voltage	4-20mA
1	+V	+V
2	GND	-V
3	S	N/C
WP	N/C	N/C
WP (-SS Only)	Case	Case

4
Mini-Fast
(-SS Only)

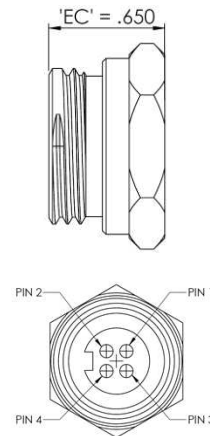

Pin	3 Wire Voltage	4-20mA
1	GND	-V
2	S	N/C
3	+V	+V
4	Case	Case

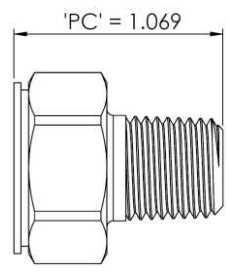
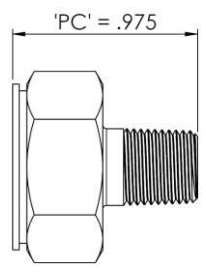
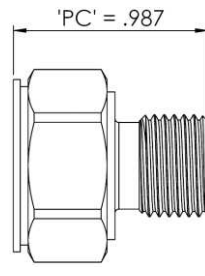
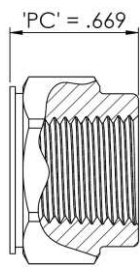
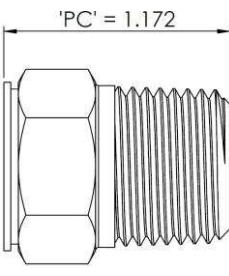
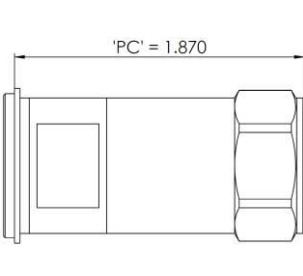
Pressure Port Option Codes			
A 1/4 NPT Male	B 1/8 NPT Male	C 1/4 BSPP Male	I 1/4 NPT Female
 <p>'PC' = 1.069</p>	 <p>'PC' = .975</p>	 <p>'PC' = .987</p>	 <p>'PC' = .669</p>
P 1/2 NPT Male	W F250C Female Autoclave		
 <p>'PC' = 1.172</p>	 <p>'PC' = 1.870</p>		

Legend	
✓	Standard Available
X	Not Available

Available Process Connection, Material Configurations & Pressure Codes

17-4PH PSI

Pressure Range	Pressure Range Code	PSI Unit	Process Connection Code					
			A	B	C	I	P	W
-14.7 - 25	V0025	P	✓	X	✓	✓	✓	X
-14.7 - 50	V0050	P	✓	✓	✓	✓	✓	X
-14.7 - 100	V0100	P	✓	✓	✓	✓	✓	X
-14.7 - 150	V0150	P	✓	✓	✓	✓	✓	X
-14.7 - 200	V0200	P	✓	✓	✓	✓	✓	X
-14.7 - 250	V0250	P	✓	✓	✓	✓	✓	X
-14.7 - 500	V0500	P	✓	✓	✓	✓	✓	X
0 - 25	00025	P	✓	X	✓	✓	✓	X
0 - 50	00050	P	✓	✓	✓	✓	✓	X
0 - 100	00100	P	✓	✓	✓	✓	✓	X
0 - 150	00150	P	✓	✓	✓	✓	✓	X
0 - 200	00200	P	✓	✓	✓	✓	✓	X
0 - 250	00250	P	✓	✓	✓	✓	✓	X
0 - 500	00500	P	✓	✓	✓	✓	✓	X
0 - 1,000	01000	P	✓	✓	✓	✓	✓	X
0 - 2,500	02500	P	✓	✓	✓	✓	✓	X
0 - 5,000	05000	P	✓	✓	✓	✓	✓	X
0 - 7,500	07500	P	X	X	✓	✓	✓	X
0 - 10,000	10000	P	X	X	X	X	X	✓

17-4PH Bar

Pressure Range	Pressure Range Code	BAR Unit	Process Connection Code					
			A	B	C	I	P	W
-1 to 2	V0002	B	✓	✓	✓	✓	✓	X
-1 to 5	V0005	B	✓	✓	✓	✓	✓	X
-1 to 7	V0007	B	✓	✓	✓	✓	✓	X
-1 to 10	V0010	B	✓	✓	✓	✓	✓	X
-1 to 20	V0020	B	✓	✓	✓	✓	✓	X
0-2	00002	B	✓	✓	✓	✓	✓	X
0-5	00005	B	✓	✓	✓	✓	✓	X
0-7	00007	B	✓	✓	✓	✓	✓	X
0-10	00010	B	✓	✓	✓	✓	✓	X
0-20	00020	B	✓	✓	✓	✓	✓	X
0-35	00035	B	✓	✓	✓	✓	✓	X
0-50	00050	B	✓	✓	✓	✓	✓	X
0-100	00100	B	✓	✓	✓	✓	✓	X
0-250	00250	B	✓	✓	✓	✓	✓	X
0-350	00350	B	✓	✓	✓	✓	✓	X
0-500	00500	B	✓	✓	✓	✓	✓	X
0-700	00700	B	✓	✓	✓	✓	✓	X

INDUSTRIAL OEM

AST4300 Pressure Transmitter

316L PSI

Pressure Range	Pressure Range Code	PSI Unit	Process Connection Code					
			A	B	C	I	P	W
-14.7 - 25	V0025	P	✓	X	✓	✓	✓	X
-14.7 - 50	V0050	P	✓	X	✓	✓	✓	X
-14.7 - 100	V0100	P	✓	X	✓	✓	✓	X
-14.7 - 150	V0150	P	✓	X	✓	✓	✓	X
-14.7 - 200	V0200	P	✓	X	✓	✓	✓	X
-14.7 - 250	V0250	P	✓	X	✓	✓	✓	X
-14.7 - 500	V0500	P	✓	X	✓	✓	✓	X
0 - 25	00025	P	✓	X	✓	✓	✓	X
0 - 50	00050	P	✓	X	✓	✓	✓	X
0 - 100	00100	P	✓	X	✓	✓	✓	X
0 - 150	00150	P	✓	X	✓	✓	✓	X
0 - 200	00200	P	✓	X	✓	✓	✓	X
0 - 250	00250	P	✓	X	✓	✓	✓	X
0 - 500	00500	P	✓	X	✓	✓	✓	X
0 - 1,000	01000	P	✓	X	✓	✓	✓	X
0 - 2,500	02500	P	✓	X	✓	✓	✓	X
0 - 5,000	05000	P	✓	X	✓	✓	✓	X
0 - 7,500	07500	P	✓	X	✓	✓	✓	X
0 - 10,000	10000	P	✓	X	✓	✓	✓	X
0 - 15,000	15000	P	X	X	X	✓	X	X
0 - 20,000	20000	P	X	X	X	X	X	✓

316L Bar

Pressure Range	Pressure Range Code	BAR Unit	Process Connection Code					
			A	B	C	I	P	W
-1 to 2	V0002	B	✓	X	✓	✓	✓	X
-1 to 5	V0005	B	✓	X	✓	✓	✓	X
-1 to 7	V0007	B	✓	X	✓	✓	✓	X
-1 to 10	V0010	B	✓	X	✓	✓	✓	X
-1 to 20	V0020	B	✓	X	✓	✓	✓	X
0-2	00002	B	✓	X	✓	✓	✓	X
0-5	00005	B	✓	X	✓	✓	✓	X
0-7	00007	B	✓	X	✓	✓	✓	X
0-10	00010	B	✓	X	✓	✓	✓	X
0-20	00020	B	✓	X	✓	✓	✓	X
0-35	00035	B	✓	X	✓	✓	✓	X
0-50	00050	B	✓	X	✓	✓	✓	X
0-100	00100	B	✓	X	✓	✓	✓	X
0-250	00250	B	✓	X	✓	✓	✓	X
0-350	00350	B	✓	X	✓	✓	✓	X
0-500	00500	B	✓	X	✓	✓	✓	X
0-700	00700	B	✓	X	✓	✓	✓	X

INDUSTRIAL OEM

AST4300 Pressure Transmitter

Inconel PSI

Pressure Range	Pressure Range Code	PSI Unit	Process Connection Code					
			A	B	C	I	P	W
-14.7 - 25	V0025	P	✓	X	X	X	✓	X
-14.7 - 50	V0050	P	✓	X	X	X	✓	X
-14.7 - 100	V0100	P	✓	X	X	X	✓	X
-14.7 - 150	V0150	P	✓	X	X	X	✓	X
-14.7 - 200	V0200	P	✓	X	X	X	✓	X
-14.7 - 250	V0250	P	✓	X	X	X	✓	X
-14.7 - 500	V0500	P	✓	X	X	X	✓	X
0 - 25	00025	P	✓	X	X	X	✓	X
0 - 50	00050	P	✓	X	X	X	✓	X
0 - 100	00100	P	✓	X	X	X	✓	X
0 - 150	00150	P	✓	X	X	X	✓	X
0 - 200	00200	P	✓	X	X	X	✓	X
0 - 250	00250	P	✓	X	X	X	✓	X
0 - 500	00500	P	✓	X	X	X	✓	X
0 - 1,000	01000	P	✓	X	X	X	✓	X
0 - 2,500	02500	P	✓	X	X	X	✓	X
0 - 5,000	05000	P	✓	X	X	X	✓	X
0 - 7,500	07500	P	✓	X	X	X	✓	X
0 - 10,000	10000	P	✓	X	X	X	✓	X
0 - 15,000	15000	P	X	X	X	✓	✓	X
0 - 20,000	20000	P	X	X	X	X	X	✓

Inconel Bar

Pressure Range	Pressure Range Code	BAR Unit	Process Connection Code					
			A	B	C	I	P	W
-1 to 2	V0002	B	✓	X	X	X	✓	X
-1 to 5	V0005	B	✓	X	X	X	✓	X
-1 to 7	V0007	B	✓	X	X	X	✓	X
-1 to 10	V0010	B	✓	X	X	X	✓	X
-1 to 20	V0020	B	✓	X	X	X	✓	X
0-2	00002	B	✓	X	X	X	✓	X
0-5	00005	B	✓	X	X	X	✓	X
0-7	00007	B	✓	X	X	X	✓	X
0-10	00010	B	✓	X	X	X	✓	X
0-20	00020	B	✓	X	X	X	✓	X
0-35	00035	B	✓	X	X	X	✓	X
0-50	00050	B	✓	X	X	X	✓	X
0-100	00100	B	✓	X	X	X	✓	X
0-250	00250	B	✓	X	X	X	✓	X
0-350	00350	B	✓	X	X	X	✓	X
0-500	00500	B	✓	X	X	X	✓	X
0-700	00700	B	✓	X	X	X	✓	X

INDUSTRIAL OEM

AST4300 Pressure Transmitter

Hastelloy PSI

Pressure Range	Pressure Range Code	PSI Unit	Process Connection Code					
			A	B	C	I	P	W
-14.7 - 25	V0025	P	✓	X	✓	X	✓	X
-14.7 - 50	V0050	P	✓	X	✓	X	✓	X
-14.7 - 100	V0100	P	✓	X	✓	X	✓	X
-14.7 - 150	V0150	P	✓	X	✓	X	✓	X
-14.7 - 200	V0200	P	✓	X	✓	X	✓	X
-14.7 - 250	V0250	P	✓	X	✓	X	✓	X
-14.7 - 500	V0500	P	✓	X	✓	X	✓	X
0 - 25	00025	P	✓	X	✓	X	✓	X
0 - 50	00050	P	✓	X	✓	X	✓	X
0 - 100	00100	P	✓	X	✓	X	✓	X
0 - 150	00150	P	✓	X	✓	X	✓	X
0 - 200	00200	P	✓	X	✓	X	✓	X
0 - 250	00250	P	✓	X	✓	X	✓	X
0 - 500	00500	P	✓	X	✓	X	✓	X
0 - 1,000	01000	P	✓	X	✓	X	✓	X
0 - 2,500	02500	P	✓	X	✓	X	✓	X
0 - 5,000	05000	P	✓	X	✓	X	✓	X
0 - 7,500	07500	P	✓	X	✓	X	✓	X
0 - 10,000	10000	P	✓	X	✓	X	✓	X
0 - 15,000	15000	P	X	X	✓	X	✓	X

Hastelloy Bar

Pressure Range	Pressure Range Code	BAR Unit	Process Connection Code					
			A	B	C	I	P	W
-1 to 2	V0002	B	✓	X	✓	X	✓	X
-1 to 5	V0005	B	✓	X	✓	X	✓	X
-1 to 7	V0007	B	✓	X	✓	X	✓	X
-1 to 10	V0010	B	✓	X	✓	X	✓	X
-1 to 20	V0020	B	✓	X	✓	X	✓	X
0-2	00002	B	✓	X	✓	X	✓	X
0-5	00005	B	✓	X	✓	X	✓	X
0-7	00007	B	✓	X	✓	X	✓	X
0-10	00010	B	✓	X	✓	X	✓	X
0-20	00020	B	✓	X	✓	X	✓	X
0-35	00035	B	✓	X	✓	X	✓	X
0-50	00050	B	✓	X	✓	X	✓	X
0-100	00100	B	✓	X	✓	X	✓	X
0-250	00250	B	✓	X	✓	X	✓	X
0-350	00350	B	✓	X	✓	X	✓	X
0-500	00500	B	✓	X	✓	X	✓	X
0-700	00700	B	✓	X	✓	X	✓	X

*See Ordering Information for list of options.

INDUSTRIAL OEM

AST4300 Pressure Transmitter

Ordering Information

AST4300	A	00500	P	4	L	1	000	-SS						
<p>Process Connection A= 1/4" NPT Male B= 1/8" NPT Male C= 1/4" BSPP Male I= 1/4" NPT Female P= 1/2" NPT Male W= F250C Female Autoclave</p>														
<p>Pressure Range Insert Pressure Range Code (see table for availability)</p>														
<p>Pressure Unit B= Bar P= PSI</p>														
<p>Output 1= 0.5-4.5V ratiometric 4= 4-20mA (2 wire loop powered) 3= 1-5V 6= 1-6V</p>														
<p>Electrical I= DIN 43650A L= Conduit fitting, Cable 2 ft. (0.6 m) M= Conduit fitting, Cable 4 ft. (1.2 m) N= Conduit fitting, Cable 6 ft. (1.8 m) P= Conduit fitting, Cable 10 ft. (3.0 m) 4 = Mini-Fast (-SS only)</p>														
<p>Wetted Material 0= 17-4PH 1= 316L 2= Inconel 718 4= Hastelloy C276</p>														
<p>Options 000= No Options</p>														
<p>Approval Type</p> <table border="1" style="width: 100%;"> <tr> <td style="width: 10%; text-align: center;">-SS</td> <td>CSA213 Class 1 Div 2 Non-Incendive Groups A, B, C, D (For Electrical Connection options I and 4 only)</td> </tr> <tr> <td style="text-align: center;">-Z</td> <td>CRN Registered to ANSI/ASME B31.3. Contact factory for material, pressure, and process connection options (includes -SS approvals)</td> </tr> <tr> <td style="text-align: center;">Left Blank</td> <td>UL ANSI/ISA 12.12.01 Class 1 Div 2 Non-Incendive Groups A, B, C, D (formerly UL1604) Not available for Electrical Connection 4</td> </tr> </table>									-SS	CSA213 Class 1 Div 2 Non-Incendive Groups A, B, C, D (For Electrical Connection options I and 4 only)	-Z	CRN Registered to ANSI/ASME B31.3. Contact factory for material, pressure, and process connection options (includes -SS approvals)	Left Blank	UL ANSI/ISA 12.12.01 Class 1 Div 2 Non-Incendive Groups A, B, C, D (formerly UL1604) Not available for Electrical Connection 4
-SS	CSA213 Class 1 Div 2 Non-Incendive Groups A, B, C, D (For Electrical Connection options I and 4 only)													
-Z	CRN Registered to ANSI/ASME B31.3. Contact factory for material, pressure, and process connection options (includes -SS approvals)													
Left Blank	UL ANSI/ISA 12.12.01 Class 1 Div 2 Non-Incendive Groups A, B, C, D (formerly UL1604) Not available for Electrical Connection 4													

Note: CSA approved products require case/earth ground electrical connection. See wiring installation sheet for further details

NORTH AMERICA

American Sensor Technologies, Inc. (AST),
 a TE Connectivity Company
 Tel: 800-522-6752
 Email: customercare.molive@te.com

ASIA

Hong Kong Sensor Technologies (HKST),
 a TE Connectivity Company
 Tel: 0400-820-6015
 Email: customercare.shzn@te.com

TE.com/sensors

Measurement Specialties, Inc., a TE Connectivity company.

Measurement Specialties, TE Connectivity, TE Connectivity (logo) and EVERY CONNECTION COUNTS are trademarks. All other logos, products and/or company names referred to herein might be trademarks of their respective owners.

The information given herein, including drawings, illustrations and schematics which are intended for illustration purposes only, is believed to be reliable. However, TE Connectivity makes no warranties as to its accuracy or completeness and disclaims any liability in connection with its use. TE Connectivity's obligations shall only be as set forth in TE Connectivity's Standard Terms and Conditions of Sale for this product and in no case will TE Connectivity be liable for any incidental, indirect or consequential damages arising out of the sale, resale, use or misuse of the product. Users of TE Connectivity products should make their own evaluation to determine the suitability of each such product for the specific application.