

## WD WIRING DUCT

PVC & Halogen Free

25/40/60/80/100/120 mm width 30/40/60/80/100 mm height



The ENTRELEC wiring duct range includes popular profile widths such as 24, 40, 60, 80, 100 and 120 mm.

The high-quality PVC & halogen free material allows the use in many applications such as standard industrial applications with PVC range to the most demanding applications such as railway, high buildings, industrial enclosure and public buildings with the low smoke and halogen free range. The specific design offers many solutions to help optimize and simplify the wiring.

### Speed up your project

- Save time while breaking off ribs without using any tools
- Additional hole on the side, allows the use of cable ties to group your cables in an efficient manner
- Speeds up your maintenance work with our cover design that eases cover removal
- Quickly mount wire retainers on the bottom rail of the duct without screwing and slide them along the rail

### Easy to install

- Special rib pattern design allows right wire placement and cable grouping
- Lower scoreline supports easier splitting of wiring duct's base and wall with no sharp edges
- Upper scoreline supports easier breaking off the ribs
- Smooth, burr-free edges help protect installers from injury and wires from damage

### For all your needs

- Low Smoke Halogen Free Wiring Ducts Family complying with EN45545-2 (R22-R23,HL3) for railway
- Flame-retardant, self-extinguishing according to UL94-V0
- Wiring duct covers hold securely even in a vertical position and under vibration
- Temperature range from -25 °C up to +90 °C

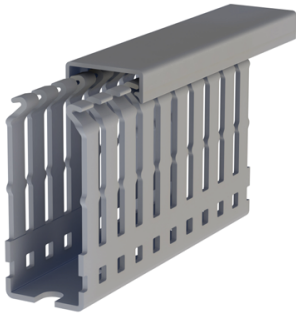

## PVC Wiring Ducts with additional holes

PVC wiring ducts with additional holes are designed to offer a great flexibility in your panel design and to save installation time.

### Features & specifications

- Can be used with cable tie thanks to additional holes on the sides
- Flame-retardant, self-extinguishing according to UL94-V0
- Upper scoreline is available for easy breaking off the ribs
- Lower scoreline at base of sidewall allow cutting out and removing sections of sidewall with no sharp edges
- Operating temperature: -5°C to 60°C
- Standard length: 2 meters
- Color: RAL 7030 Grey
- Complies with RoHS regulations
- Complies with IEC 60695-2-1 and EN 50085-2-3 standards

### Product ordering information

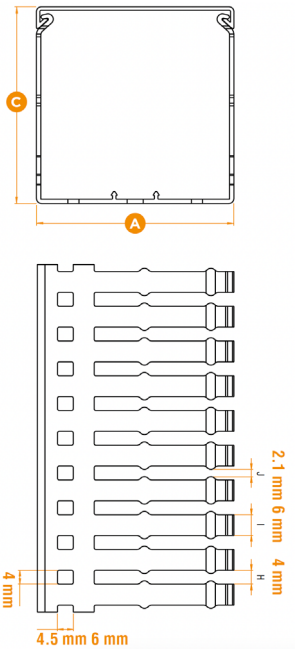

Size Width (A) x Height (C)		Type	Part Number	Packing
mm	in			Qty
25 x 30	0.98 x 1.18	WD-1-DP-GR2530	1SET411008R0000	50 x 2 m (78.74 in)
25 x 40	0.98 x 1.57	WD-1-DP-GR2540	1SET411009R0000	50 x 2 m (78.74 in)
25 x 60	0.98 x 2.36	WD-1-DP-GR2560	1SET411010R0000	30 x 2 m (78.74 in)
25 x 80	0.98 x 3.15	WD-1-DP-GR2580	1SET411011R0000	28 x 2 m (78.74 in)
25 x 100	0.98 x 3.94	WD-1-DP-GR2510	1SET411007R0000	22 x 2 m (78.74 in)
40 x 40	1.57 x 1.57	WD-1-DP-GR4040	1SET411013R0000	26 x 2 m (78.74 in)
40 x 60	1.57 x 2.36	WD-1-DP-GR4060	1SET411014R0000	18 x 2 m (78.74 in)
40 x 80	1.57 x 3.15	WD-1-DP-GR4080	1SET411015R0000	20 x 2 m (78.74 in)
40 x 100	1.57 x 3.94	WD-1-DP-GR4010	1SET411012R0000	14 x 2 m (78.74 in)
60 x 40	2.36 x 1.57	WD-1-DP-GR6040	1SET411017R0000	18 x 2 m (78.74 in)
60 x 60	2.36 x 2.36	WD-1-DP-GR6060	1SET411018R0000	12 x 2 m (78.74 in)
60 x 80	2.36 x 3.15	WD-1-DP-GR6080	1SET411019R0000	12 x 2 m (78.74 in)
60 x 100	2.36 x 3.94	WD-1-DP-GR6010	1SET411016R0000	18 x 2 m (78.74 in)
80 x 40	3.15 x 1.57	WD-1-DP-GR8040	1SET411021R0000	18 x 2 m (78.74 in)
80 x 60	3.15 x 2.36	WD-1-DP-GR8060	1SET411022R0000	14 x 2 m (78.74 in)
80 x 80	3.15 x 3.15	WD-1-DP-GR8080	1SET411023R0000	10 x 2 m (78.74 in)
80 x 100	3.15 x 3.94	WD-1-DP-GR8010	1SET411020R0000	12 x 2 m (78.74 in)
100 x 60	3.94 x 2.36	WD-1-DP-GR1006	1SET411002R0000	10 x 2 m (78.74 in)
100 x 80	3.94 x 3.15	WD-1-DP-GR1008	1SET411003R0000	8 x 2 m (78.74 in)
100 x 100	3.94 x 3.94	WD-1-DP-GR1001	1SET411001R0000	12 x 2 m (78.74 in)
120 x 60	4.72 x 2.36	WD-1-DP-GR1206	1SET411005R0000	8 x 2 m (78.74 in)
120 x 80	4.72 x 3.15	WD-1-DP-GR1208	1SET411006R0000	6 x 2 m (78.74 in)
120 x 100	4.72 x 3.94	WD-1-DP-GR1201	1SET411004R0000	10 x 2 m (78.74 in)

Note: Covers are included in the wiring duct packaging





## PVC Wiring Ducts Covers

PVC wiring ducts covers are designed to ease cover removal when ducts are fully wired. They hold securely even in a vertical position and under vibration.

### Product ordering information

Size Width (A)		Color	Type	Part Number	Packing Qty
mm	in				
25	0.98	Grey 	WD-1-CP-GR025	1SET411201R0000	16 x 2 m (78.74 in)
40	1.57		WD-1-CP-GR040	1SET411202R0000	16 x 2 m (78.74 in)
60	2.36		WD-1-CP-GR060	1SET411203R0000	6 x 2 m (78.74 in)
80	3.15		WD-1-CP-GR080	1SET411204R0000	6 x 2 m (78.74 in)
100	3.94		WD-1-CP-GR100	1SET411205R0000	8 x 2 m (78.74 in)
120	4.72		WD-1-CP-GR120	1SET411206R0000	6 x 2 m (78.74 in)

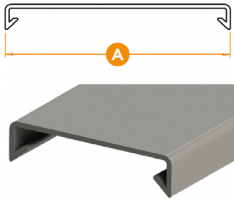

## LSHF low smoke halogen free Wiring Ducts

The LSHF Low Smoke Halogen Free Wiring Ducts are designed to offer excellent fire safety characteristics and are suitable for use in harsh environments.

### Features & specifications

- Flame-retardant, self-extinguishing according to UL94-V0
- Low smoke
- Complying with EN 45545-2 (R22-R23, HL3) for railway
- Smooth, burr-free edges help protect installers from injury and wires from damage
- Upper scoreline is available for easy breaking off the ribs
- Lower scoreline at base of sidewall allow cutting out and removing sections of sidewall with no sharp edges
- Operating temperature: -25°C to 90°C
- Standard length: 2 meters
- Material: PC/ABS
- Color: RAL 7035 Grey
- Complies with RoHS regulations
- Complies with EN 50085-2-3 standards

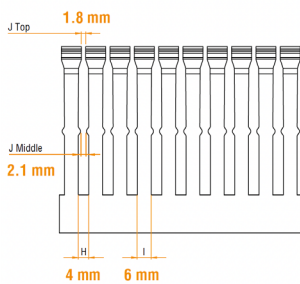
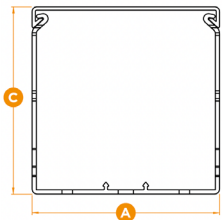
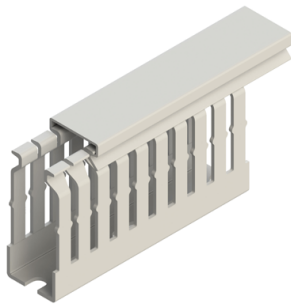

### Product ordering information

Size Width (A) x Height (C)		Type	Part Number	Packing Qty
mm	in			
25 x 30	0.98 x 1.18	WD-1-DH-GR2530	1SET411101R0000	46 x 2 m (78.74 in)
25 x 40	0.98 x 1.57	WD-1-DH-GR2540	1SET411102R0000	50 x 2 m (78.74 in)
25 x 60	0.98 x 2.36	WD-1-DH-GR2560	1SET411103R0000	30 x 2 m (78.74 in)
40 x 40	1.57 x 1.57	WD-1-DH-GR4040	1SET411104R0000	24 x 2 m (78.74 in)
40 x 60	1.57 x 2.36	WD-1-DH-GR4060	1SET411105R0000	18 x 2 m (78.74 in)
40 x 80	1.57 x 3.15	WD-1-DH-GR4080	1SET411106R0000	20 x 2 m (78.74 in)
60 x 40	2.36 x 1.57	WD-1-DH-GR6040	1SET411107R0000	18 x 2 m (78.74 in)
60 x 60	2.36 x 2.36	WD-1-DH-GR6060	1SET411108R0000	12 x 2 m (78.74 in)
60 x 80	2.36 x 3.15	WD-1-DH-GR6080	1SET411109R0000	12 x 2 m (78.74 in)
80 x 60	3.15 x 2.36	WD-1-DH-GR8060	1SET411110R0000	14 x 2 m (78.74 in)
80 x 80	3.15 x 3.15	WD-1-DH-GR8080	1SET411111R0000	10 x 2 m (78.74 in)

Note: Covers are included in the wiring duct packaging





## LSHF low smoke halogen free Wiring Ducts covers

LSHF wiring ducts covers are designed to ease cover removal when ducts are fully wired. They hold securely even in a vertical position and under vibration.

### Product ordering information

Size Width (A)		Color	Type	Part Number	Packing Qty
mm	in				
25	0.98	Grey ■	WD-1-CH-GR025	1SET411250R0000	14 x 2 m (78.74 in)
40	1.57		WD-1-CH-GR040	1SET411251R0000	12 x 2 m (78.74 in)
60	2.36		WD-1-CH-GR060	1SET411252R0000	6 x 2 m (78.74 in)
80	3.15		WD-1-CH-GR080	1SET411253R0000	8 x 2 m (78.74 in)

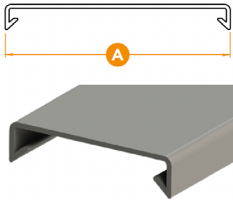

## PVC Wiring Ducts accessories

Our accessories ease wire management within the cable ducts.

### Features & specifications

- Wire retainer help wire management. They can easily be mounted on the bottom rail of the duct without screwing and slide them along the rail
- Cable clamp associated with wire ties help in maintaining firmly the cables. As wire retainer, they can easily be mounted on the bottom rail of the duct without screwing and slide them along the rail
- Cable holder are clipped onto the ribs to maintain large bundles of wires

### Product ordering information

Size Width (A) x Height (C)		Color	Type	Part Number	Packing Qty
mm	in				
<b>Wire retainer <sup>(1)</sup></b>					
40 x 40	1.57 x 1.57	Black ■	WD-1-RT-4040	1SET411301R0000	10
40 x 60	1.57 x 2.36		WD-1-RT-4060	1SET411302R0000	10
40 x 80	1.57 x 3.15		WD-1-RT-4080	1SET411304R0000	10
60 x 40	2.36 x 1.57		WD-1-RT-6040	1SET411305R0000	10
60 x 60	2.36 x 2.36		WD-1-RT-6060	1SET411306R0000	10
60 x 80	2.36 x 3.15		WD-1-RT-6080	1SET411303R0000	10
60 x 100	2.36 x 3.94		WD-1-RT-6010	1SET411307R0000	10
80 x 60	3.15 x 2.36		WD-1-RT-8060	1SET411308R0000	10
80 x 80	3.15 x 3.15		WD-1-RT-8080	1SET411311R0000	10
80 x 100	3.15 x 3.94		WD-1-RT-8010	1SET411312R0000	10
100 x 60	3.94 x 2.36		WD-1-RT-1006	1SET411309R0000	10
100 x 80	3.94 x 3.15		WD-1-RT-1008	1SET411313R0000	10
100 x 100	3.94 x 3.94		WD-1-RT-1001	1SET411314R0000	10
120 x 60	4.72 x 2.36		WD-1-RT-1206	1SET411310R0000	10
120 x 80	4.72 x 3.15	WD-1-RT-1208	1SET411315R0000	10	
120 x 100	4.72 x 3.94	WD-1-RT-1201	1SET411316R0000	10	

### Body-bound rivet <sup>(2)</sup>

6.5	0.25	Grey ■	WD-1-TL-0002	1SET411402R0000	100
-----	------	--------	--------------	-----------------	-----

### Cable <sup>(2)</sup>

Cable clamp	Black ■	WD-1-TL-0003	1SET411403R0000	10
Cable holder		WD-1-TL-0004	1SET411404R0000	10

1. Only compatible with PVC range
2. Compatible with PVC and LSHF ranges



Wire retainer



Body-bound rivet



Cable clamp



Cable holder

# WD WIRING DUCT



Hand held wiring duct cutter

## Wiring ducts tools for PVC and Low Smoke Halogen Free ranges

Wiring ducts tools are designed to help optimize preparation work and mounting inside the panel.

### Product ordering information

Description	Type	Part Number	Packing Qty
Setting tool for rivets	WD-1-TL-0001	1SET411401R0000	1
Hand held wiring duct cutter	WD-1-TL-0007	1SET411407R0000	1

## Products dimensions

Wiring duct

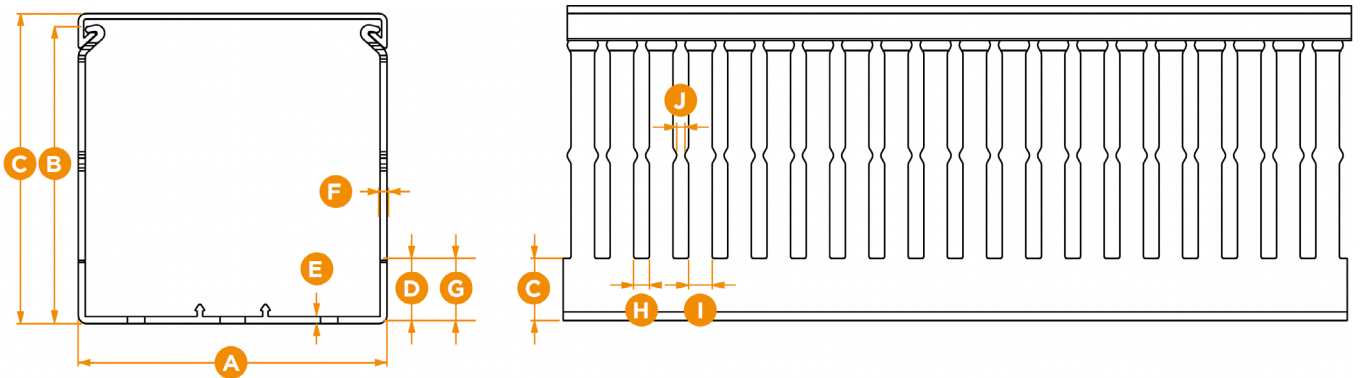

### Product ordering information and product dimensions

Size Width (A) x Height (C)	Color	Type	Part Number	A		B		C		D		E		F		G		H		I		J		
				mm	in	mm	in	mm	in	mm	in	mm	in	mm	in	mm	in	mm	in	mm	in	mm	in	mm
<b>PVC Wiring Duct</b>																								
25 x 30	0.98 x 1.18	Grey	WD-1-DP-GR2530	1SET411008R0000	25	0.98	26.4	1.04	30	1.18	10	0.39	1.4	0.05	1.4	0.05	11.4	0.44	4	0.16	6	0.24	2.1	0.08
25 x 40	0.98 x 1.57		WD-1-DP-GR2540	1SET411009R0000	25	0.98	36.2	1.43	40	1.57	11	0.43	1.4	0.05	1.4	0.05	12.4	0.48	4	0.16	6	0.24	2.1	0.08
25 x 60	0.98 x 2.36		WD-1-DP-GR2560	1SET411010R0000	25	0.98	56.4	2.22	60	2.36	12	0.47	1.6	0.06	1.6	0.06	13.6	0.53	4	0.16	6	0.16	2.1	0.08
25 x 80	0.98 x 3.15		WD-1-DP-GR2580	1SET411011R0000	25	0.98	76.8	3.02	80	3.15	14	0.55	1.8	0.07	1.8	0.07	15.8	0.62	4	0.16	6	0.24	2.1	0.08
25 x 100	0.98 x 3.94		WD-1-DP-GR2510	1SET411007R0000	25	0.98	96.6	3.80	100	3.94	16	0.63	1.9	0.07	1.9	0.07	17.9	0.70	4	0.16	6	0.24	2.1	0.08
40 x 40	1.57 x 1.57		WD-1-DP-GR4040	1SET411013R0000	40	1.57	36.5	1.43	40	1.57	11	0.43	1.4	0.05	1.4	0.05	12.4	0.48	4	0.16	6	0.24	2.1	0.08
40 x 60	1.57 x 2.36		WD-1-DP-GR4060	1SET411014R0000	40	1.57	56.5	2.22	60	2.36	12	0.47	1.6	0.06	1.6	0.06	13.6	0.53	4	0.16	6	0.24	2.1	0.08
40 x 80	1.57 x 3.15		WD-1-DP-GR4080	1SET411015R0000	40	1.57	76.8	3.02	80	3.15	14	0.55	1.8	0.07	1.8	0.07	15.8	0.62	4	0.16	6	0.24	2.1	0.08
40 x 100	1.57 x 3.94		WD-1-DP-GR4010	1SET411012R0000	40	1.57	96.9	3.81	100	3.94	16	0.63	1.9	0.07	2	0.07	17.9	0.70	4	0.16	6	0.24	2.1	0.08
60 x 40	2.36 x 1.57		WD-1-DP-GR6040	1SET411017R0000	60	2.36	36.8	1.45	40	1.57	11	0.43	1.6	0.06	1.6	0.06	12.6	0.49	4	0.16	6	0.24	2.1	0.08
60 x 60	2.36 x 2.36		WD-1-DP-GR6060	1SET411018R0000	60	2.36	56.8	2.23	60	2.36	12	0.47	1.8	0.07	1.8	0.07	13.8	0.54	4	0.16	6	0.24	2.1	0.08
60 x 80	2.36 x 3.15		WD-1-DP-GR6080	1SET411019R0000	60	2.36	76.7	3.02	80	3.15	14	0.55	1.8	0.07	1.8	0.07	15.8	0.62	4	0.16	6	0.24	2.1	0.08
60 x 100	2.36 x 3.94		WD-1-DP-GR6010	1SET411016R0000	60	2.36	96.9	3.81	100	3.94	16	0.63	2	0.07	2	0.07	18	0.70	4	0.16	6	0.24	2.1	0.08
80 x 40	3.15 x 1.57		WD-1-DP-GR8040	1SET411021R0000	80	3.15	36.8	1.45	40	1.57	11	0.43	1.6	0.06	1.6	0.06	12.6	0.49	4	0.16	6	0.24	2.1	0.08
80 x 60	3.15 x 2.36		WD-1-DP-GR8060	1SET411022R0000	80	3.15	57	2.24	60	2.36	12	0.47	1.8	0.07	1.8	0.07	13.8	0.54	4	0.16	6	0.24	2.1	0.08
80 x 80	3.15 x 3.15		WD-1-DP-GR8080	1SET411023R0000	80	3.15	77.1	3.03	80	3.15	14	0.55	1.8	0.07	1.8	0.07	15.8	0.62	4	0.16	6	0.24	2.1	0.08
80 x 100	3.15 x 3.94		WD-1-DP-GR8010	1SET411020R0000	80	3.15	97.2	3.82	100	3.94	16	0.63	2.2	0.08	2.2	0.08	18.2	0.71	4	0.16	6	0.24	2.1	0.08
100 x 60	3.94 x 2.36		WD-1-DP-GR1006	1SET411002R0000	100	3.94	57.3	2.25	60	2.36	12	0.47	2	0.07	2	0.07	14	0.55	4	0.16	6	0.24	2.1	0.08
100 x 80	3.94 x 3.15		WD-1-DP-GR1008	1SET411003R0000	100	3.94	77.2	3.04	80	3.15	14	0.55	2	0.07	2	0.07	16	0.63	4	0.16	6	0.24	2.1	0.08
100 x 100	3.94 x 3.94		WD-1-DP-GR1001	1SET411001R0000	100	3.94	97.2	3.82	100	3.94	16	0.63	2.2	0.08	2.2	0.08	18.2	0.71	4	0.16	6	0.24	2.1	0.08
120 x 60	4.72 x 2.36		WD-1-DP-GR1206	1SET411005R0000	120	4.72	57.6	2.26	60	2.36	12	0.47	2.3	0.09	2	0.07	14.3	0.56	4	0.16	6	0.24	2.1	0.08
120 x 80	4.72 x 3.15		WD-1-DP-GR1208	1SET411006R0000	120	4.72	77.5	3.05	80	3.15	14	0.55	2.3	0.09	2	0.07	16.3	0.64	4	0.16	6	0.24	2.1	0.08
120 x 100	4.72 x 3.94		WD-1-DP-GR1201	1SET411004R0000	120	4.72	97.5	3.84	100	3.94	16	0.63	2.4	0.09	2.4	0.09	18.4	0.72	4	0.16	6	0.24	2.1	0.08
<b>Low smoke halogen free Wiring Duct</b>																								
25 x 30	0.98 x 1.18	Grey	WD-1-DH-GR2530	1SET411101R0000	25	0.98	26.6	1.05	30	1.18	8	0.31	1.55	0.06	1.55	0.06	9.55	0.38	4	0.16	6	0.24	1.8 - 2.1	0.07-0.08
25 x 40	0.98 x 1.57		WD-1-DH-GR2540	1SET411102R0000	25	0.98	36.8	1.45	40	1.57	10	0.39	1.6	0.06	1.6	0.06	11.6	0.46	4	0.16	6	0.24	1.8 - 2.1	0.07-0.08
25 x 60	0.98 x 2.36		WD-1-DH-GR2560	1SET411103R0000	25	0.98	56.8	2.24	60	2.36	12	0.47	1.6	0.06	1.6	0.06	13.6	0.54	4	0.16	6	0.24	1.8 - 2.1	0.07-0.08
40 x 40	1.57 x 1.57		WD-1-DH-GR4040	1SET411104R0000	40	1.57	36.9	1.45	40	1.57	10	0.39	1.6	0.06	1.6	0.06	11.6	0.46	4	0.16	6	0.24	1.8 - 2.1	0.07-0.08
40 x 60	1.57 x 2.36		WD-1-DH-GR4060	1SET411105R0000	40	1.57	56.9	2.24	60	2.36	12	0.47	1.6	0.06	1.6	0.06	13.6	0.54	4	0.16	6	0.24	1.8 - 2.1	0.07-0.08
40 x 80	1.57 x 3.15		WD-1-DH-GR4080	1SET411106R0000	40	1.57	76.9	3.03	80	3.15	14	0.55	1.8	0.07	1.8	0.07	15.8	0.62	4	0.16	6	0.24	1.8 - 2.1	0.07-0.08
60 x 40	2.36 x 1.57		WD-1-DH-GR6040	1SET411107R0000	60	2.36	37	1.46	40	1.57	10	0.39	1.6	0.06	1.6	0.06	11.6	0.46	4	0.16	6	0.24	1.8 - 2.1	0.07-0.08
60 x 60	2.36 x 2.36		WD-1-DH-GR6060	1SET411108R0000	60	2.36	57.1	2.25	60	2.36	12	0.47	1.8	0.07	1.8	0.07	13.8	0.54	4	0.16	6	0.24	1.8 - 2.1	0.07-0.08
60 x 80	2.36 x 3.15		WD-1-DH-GR6080	1SET411109R0000	60	2.36	77.1	3.04	80	3.15	14	0.55	1.9	0.07	1.9	0.07	15.9	0.63	4	0.16	6	0.24	1.8 - 2.1	0.07-0.08
80 x 60	3.15 x 2.36		WD-1-DH-GR8060	1SET411110R0000	80	3.15	57.1	2.25	60	2.36	12	0.47	1.8	0.07	1.8	0.07	13.8	0.54	4	0.16	6	0.24	1.8 - 2.1	0.07-0.08
80 x 80	3.15 x 3.15		WD-1-DH-GR8080	1SET411111R0000	80	3.15	77.1	3.04	80	3.15	14	0.55	2	0.08	2	0.08	16	0.63	4	0.16	6	0.24	1.8 - 2.1	0.07-0.08

# WD WIRING DUCT

## Products dimensions

Wire retainer

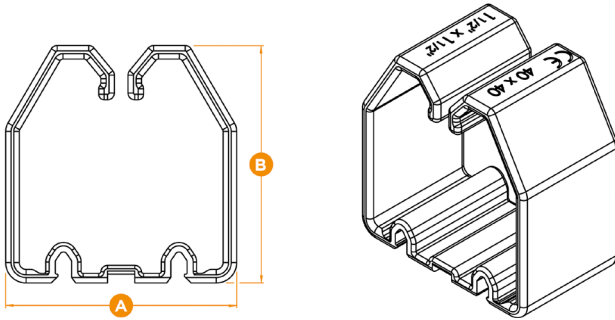

### Product ordering information and product dimensions

Size Width (A) x Height (C)		Type	Part Number	A		B	
mm	in			mm	in	mm	in
40 x 40	1.57 x 1.57	WD-1-RT-4040	1SET411301R0000	34	1.34	35	1.38
40 x 60	1.57 x 2.36	WD-1-RT-4060	1SET411302R0000	34	1.34	53	2.09
40 x 80	1.57 x 3.15	WD-1-RT-4080	1SET411304R0000	34	1.34	75	2.95
60 x 40	2.36 x 1.57	WD-1-RT-6040	1SET411305R0000	53	2.09	35	1.38
60 x 60	2.36 x 2.36	WD-1-RT-6060	1SET411306R0000	53	2.09	53	2.09
60 x 80	2.36 x 3.15	WD-1-RT-6080	1SET411303R0000	53	2.09	75	2.95
60 x 100	2.36 x 3.94	WD-1-RT-6010	1SET411307R0000	53	2.09	95	3.74
80 x 60	3.15 x 2.36	WD-1-RT-8060	1SET411308R0000	73	2.87	53	2.09
80 x 80	3.15 x 3.15	WD-1-RT-8080	1SET411311R0000	73	2.87	75	2.95
80 x 100	3.15 x 3.94	WD-1-RT-8010	1SET411312R0000	73	2.87	95	3.74
100 x 60	3.94 x 2.36	WD-1-RT-1006	1SET411309R0000	93	3.66	53	2.09
100 x 80	3.94 x 3.15	WD-1-RT-1008	1SET411313R0000	93	3.66	75	2.95
100 x 100	3.94 x 3.94	WD-1-RT-1001	1SET411314R0000	93	3.66	95	3.74
120 x 60	4.72 x 2.36	WD-1-RT-1206	1SET411310R0000	113	4.45	53	2.09
120 x 80	4.72 x 3.15	WD-1-RT-1208	1SET411315R0000	113	4.45	75	2.95
120 x 100	4.72 x 3.94	WD-1-RT-1201	1SET411316R0000	113	4.45	95	3.74

## Cable Clamp & Holder

Cable Clamp

Cable Holder

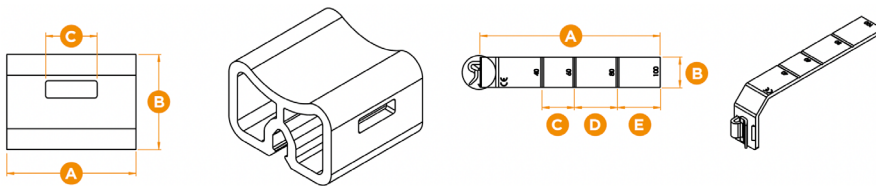

### Product ordering information and product dimensions

Description	Type	Part Number	A		B		C		D		E	
			mm	in	mm	in	mm	in	mm	in	mm	in
Cable clamp	WD-1-TL-0003	1SET411403 R0000	15	0.59	11	0.43	6	0.24				
Cable holder	WD-1-TL-0004	1SET411404 R0000	83.6	3.29	14	0.55	15	0.59	20	0.78	19.8	0.78



---

**te.com**

© 2023 TE Connectivity Ltd. family of companies. All Rights Reserved.

ENTRELEC, TE Connectivity, TE connectivity (logo) and Every Connection Counts are trademarks. All other logos, products and/or company names referred to herein might be trademarks of their respective owners.

While TE has made every reasonable effort to ensure the accuracy of the information in this brochure, TE does not guarantee that it is error-free, nor does TE make any other representation, warranty or guarantee that the information is accurate, correct, reliable or current. TE reserves the right to make any changes to the information contained herein without prior notice. TE Connectivity assumes only those obligations set forth in the terms and conditions for this product and shall in no event be liable for any incidental, indirect, or consequential damages arising out of the sale, resale, use, or misapplication of the product. TE expressly disclaims any implied warranties with respect to the information contained herein, including, but not limited to, implied warranties of merchantability or fitness for a particular purpose. Dimensions, specifications and/or information contained herein are for reference purposes only and are subject to change without notice. Consult TE for the latest dimensions, specifications and/or information. Users of TE Connectivity products must make their own assessment as to whether the respective product is suitable for the respective desired application.

INDUSTRIAL / WD WIRING DUCT / BROCHURE / EN 07/23

**BROCHURE**

TE Connectivity  
3, rue Jean Perrin  
69687 Chassieu cedex  
France  
Tel: +33 481923100

