



FP20 AUTO MULTI-PORT ANTENNAS

INTELLIGENT TRANSPORTATION

Datasheet & Kit Configurator Guide



FP20 AUTO MULTI-PORT VEHICLE ANTENNAS

FP20 auto antennas provide a combination of 4G, 5G, CBRS, Wi-Fi, Bluetooth and GNSS to address your connectivity requirements.

The product family includes multi-port aerodynamic solutions up to 9 ports, along with a range of additional whip antenna and connector options to suit all major vehicular gateways and routers.

FEATURES AND BENEFITS

- 6, 7, 8 and 9 port options available
- Wideband coverage
- 4G/5G, Wi-Fi 6E/7, Bluetooth, GNSS L1+L5 and optional VHF, UHF or 700/800/900 MHz (via high power whip port) coverage from a single antenna
- Cost-effective solution to increase bandwidth and signal strength
- Stylish and aesthetic design

KEY DIFFERENTIATORS

- L1 and L5 GNSS for improved positioning accuracy and response times
 - Dual-GNSS option available
- Out of band rejection filters maintain consistent performance
- High data throughput is enabled by technologies such as carrier aggregation
- Coverage of all LTE/5G bands (617-7125 MHz), Wi-Fi 6E/7, Bluetooth and GNSS
- Truly global coverage of LTE and 5G sub-6 GHz frequencies and bands
- Superior gain patterns, low gain ripple, high gain at horizon and efficiency over 70%
- UV, flammability, humidity, impact, vibration, shock certified
- IP67 and IP69K rated for improved durability

TABLE OF CONTENTS

- [FP20 auto kit overview](#)
- [FP20 auto kit configurations](#)
- [FP20 auto base antenna specifications](#)
- [FP20 auto base antenna radiation patterns](#)
- [FP20 auto base antenna mechanical drawings](#)

FP20 AUTO: ANTENNA OVERVIEW



1 Port Options:

- 6 Port
- 7 Port
- 8 Port
- 9 Port

2 Whip Options:

- UHF - TETRA 380-430 MHz
- UHF 450-470 MHz
- UHF - 470-512 MHz
- 7/8/900 Band - 740-960 MHz
- Multi-Band - 150, 450, 7/800 MHz

3 Extension Cable Connector Options:

- SMA
- RP-SMA
- TNC
- QMA
- FAKRA

And More

EXAMPLES OF CONNECTOR TERMINATIONS ON EXTENSION CABLES

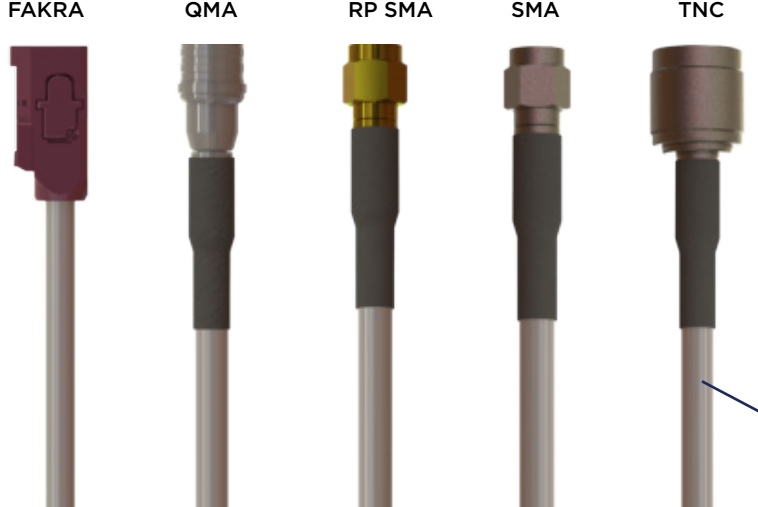

Extension Cables

All kits are supplied with a 5m extension cable set as standard (see pages 4-5 for standard extension cable connector options). Custom configurations are available on request.

Connectors will be individually marked with an appropriate label which is color coded to guide installers in connecting extension cables to the correct port on the router or gateway device.





4G/5G GNSS BT

WLAN

FP20 AUTO: KIT CONFIGURATIONS

The table below shows common examples of the **FP20 auto** kit configurations and the part numbers used to order these kits. Other kit options are available on request.

All kits are supplied with 5 meter (16 ft.) extension cables as standard. If you require different extension cable lengths or connector configurations please contact us to discuss your options.

Example FP20 auto Base	Port Configuration	Frequency (MHz)	Extension Cable Connector
6 Port Option 1 (No Whip Port) - Kit Part No. - L000423-01			
	4G/5G Port x 2	617-7125	SMA Male x 2
	Wi-Fi/Bluetooth Port x 3	2400-2500; 4900-6000	RP-SMA Male x 3
	GNSS Port x 1	L1: 1561 / 1575.42 / 1602 L5: 1176.45	SMA Male x 1
6 Port Option 2 (Inc. Whip Port) - Kit Part No. - L000423-07			
	4G/5G Port x 2	617-7125	SMA Male x 2
	Wi-Fi/Bluetooth Port x 2	2400-2500; 4900-7200	RP-SMA Male x 2
	GNSS Port x 1	L1: 1561 / 1575.42 / 1602 L5: 1176.45	SMA Male x 1
	Whip Port x 1	See below for options available	TNC Male x 1
7 Port Option 1 (Inc. Whip Port) - Kit Part No. - L000423-02			
	4G/5G Port x 2	617-7125	SMA Male x 2
	Wi-Fi/Bluetooth Port x 2	2400-2500; 4900-7200	FAKRA I x 1 FAKRA Z x 1
	GNSS Port x 2	L1: 1561 / 1575.42 / 1602 L5: 1176.45	FAKRA C x 1 SMA Male x 1
	Whip Port x 1	See below for options available	TNC Male x 1
7 Port Option 2 (Inc. Whip Port) - Kit Part No. - L000423-03			
	4G/5G Port x 2	617-7125	SMA Male x 2
	Wi-Fi/Bluetooth Port x 2	2400-2500; 4900-7200	RP-SMA Male x 2
	GNSS Port x 2	L1: 1561 / 1575.42 / 1602 L5: 1176.45	SMA Male x 2
	Whip Port x 1	See below for options available	SMA Male x 1

Example FP20 auto Base	Port Configuration	Frequency (MHz)	Extension Cable Connector
8 Port (Inc. Whip Port) - Kit Part No. - L000423-04			
	4G/5G Port x 2	617-7125	SMA Male x 2
	Wi-Fi/Bluetooth Port x 4	2400-2500; 4900-7200	RP-SMA Male x 4
	GNSS Port x 1	L1: 1561 / 1575.42 / 1602 L5: 1176.45	SMA Male x 1
	Whip Port x 1	See below for options available	TNC Male x 1
9 Port Option 1 (Inc. Whip Port) - Kit Part No. L000423-05			
	4G/5G Port x 2	617-7125	SMA Male x 2
	Wi-Fi/Bluetooth Port x 4	2400-2500; 4900-7200	RP-SMA Male x 3 QMA Male x 1
	GNSS Port x 2	L1: 1561 / 1575.42 / 1602 L5: 1176.45	SMA Male x 1 QMA Male x 1
	Whip Port x 1	See below for options available	QMA Male x 1
9 Port Option 2 (Inc. Whip Port) - Kit Part No. - L000423-06			
	4G/5G Port x 2	617-7125	SMA Male x 2
	Wi-Fi/Bluetooth Port x 4	2400-2500; 4900-7200	RP-SMA Male x 4
	GNSS Port x 2	L1: 1561 / 1575.42 / 1602 L5: 1176.45	SMA Male x 2
	Whip Port x 1	See below for options available	TNC Male x 1

Additional Whip Options (For 6-9 Inc. Whip Port Models)*				
SINGLE BAND				TRI-BAND
UHF - TETRA	UHF	UHF	7/800 Band	Multi-Band
380-430 MHz	450-470 MHz	470-512 MHz	740-960 MHz	150, 450, 700/800/900 MHz
Part No. - L000410-01	Part No. - L000410-02	Part No. - L000410-03	Part No. - L000410-04	Part No. - L000340-01
FP20 auto whip port and the associated whip antennas are designed to handle 60 watts				

***Please note whip antenna part numbers are not included in a standard FP20 auto kit**

The part numbers above must be ordered separately. When placing an order please state the kit number from the tables above plus the additional whip antenna part number and quantities required for both kit and whip.

FP20 AUTO: SPECIFICATIONS

The following specifications are representative of all models/port options in the FP20 auto antenna family. Unless stated the data includes testing of the antenna only and does not include testing with a 5 meter (16 feet) extension cable. For more detailed information please contact us.

ELECTRICAL SPECIFICATION - 4G/5G/CBRS (CELLULAR), WI-FI 6E/7								
	LTE 5G				Wi-Fi			
Operating Frequency (MHz)	617-698	698-960	1427-1511	1690-4000	4000-7125	2400-2500	4900-6000	6000-7125
VSWR - Max*	< 3.0 : 1	< 2.5 : 1	< 2.5 : 1	< 2.0 : 1	< 2.0 : 1	< 2.0 : 1	< 2.0 : 1	< 2.0 : 1
Isolation (dB)	> 10		> 15		> 15			
Peak Gain - Max (dBi)*	3.7	2.0	4.6	3.3	3.0	4.8	2.5	
Total Efficiency Average	70%	37%	63%	52%	56%	59%	56%	
Correlation Coefficient	< 0.2							
Nominal Impedance (Ohms)	50							
Input Power Max (W)	10							
Polarization	Linear Vertical							
Azimuth Beamwidth	360°, Omnidirectional							

* Measured on 0.6 x 0.6m (2 x 2ft) ground plane with 5m (16ft) low loss cable

ELECTRICAL SPECIFICATION - GNSS - 1 GNSS PORT MODELS*				
No. of Ports	1			
Frequency, MHz	L1 Band			L5 Band
	1561	1575.42	1602	1176.45
VSWR (Typ.)	2.0	2.1	2.0	1.6
Patch Peak Gain, dBi	-5.2	0.6	-0.3	1.1
LNA Gain, dB	28 ± 3			
Noise Figure, dB	< 3			
Input Max Power, dBm	+10			
Out of Band Rejection, dBc	350-520 MHz			> 65
	698-960 MHz			> 70
	1428-1511 MHz			> 40
	1710-2700 MHz			> 65
	4900-5800 MHz			> 75
DC Voltage, V	2 - 5			
Current, mA	12.5 Typ. (at DC 3.0V)			
Nominal Impedance Ω	50			
Polarization	RHCP			

*Measured on 0.6 x 0.6m (2 x 2ft) ground plane

ELECTRICAL SPECIFICATION - GNSS - 2 GNSS PORT MODELS**				
No. of Ports	2			
Frequency, MHz	L1 Band			L5 Band
	1561	1575.42	1602	1176.45
VSWR (Typ.)	1.6	1.8	1.5	1.4
Patch Peak Gain, dBi	6.4	5.8	4.8	2.2
LNA Gain, dB	26 ± 3		25 ± 3	28 ± 3
Noise Figure, dB	< 3			
Input Max Power, dBm	+10			
Out of Band Rejection, dBc	350-520 MHz			> 65
	698-960 MHz			> 70
	1428-1511 MHz			> 40
	1710-2700 MHz			> 65
	4900-5800 MHz			> 75
DC Voltage, V	2 - 5			
Current, mA	12.5 Typ. (at DC 3.0V)			
Nominal Impedance Ω	50			
Polarization	RHCP			

**Measured on 0.6 x 0.6m (2 x 2ft) ground plane

EXTENSION CABLE ATTENUATION FIGURES - 5MM (0.195 INCH) CABLES											
Frequency Range (MHz)	698	960	1511	2500	2700	3300	4200	4400	4900	6000	7125
Cable Attenuation (dB/m)	< 0.3	< 0.4	< 0.5	< 0.7	< 0.7	< 0.8	< 0.9	< 1.0	< 1.1	< 1.2	< 1.3

MECHANICAL SPECIFICATION	
Dimensions - No External Whip Models - LxWxH (mm (in.))	245 X 63 X 84 (9.6 X 2.5 X 3.3)* *Not Including External Whip - Height Varies by Whip Model
Weight - g (oz.) - Not Including Extension Cables or Whip Antennas	365-416 (dependent on model)
Number of Ports	6 to 9 Port Options Available
Mounting Type	Permanent - Locking Nut
Radome	Polycarbonate, UL94-V0

ENVIRONMENTAL SPECIFICATION	
Operating Temperature - °C (°F)	-40 to +85 (-40 to +185)
Storage Temperature - °C (°F)	-40 to +85 (-40 to +185)
Ingress Protection	IP67, IP69K
UV Rating	ASTM D4674
Flammability Rating	Radome: UL94 V0 Cable: UN ECE R118
Mechanical Shock Rating	IEC 60068-2-27, Secured Cross Country Vehicles
Vibration Test Rating	MIL-STD-810G, Method 514.6, Category 4, Highway Truck Vibration
Humidity Rating	MIL-STD-810G, 507.5, Procedure II, Aggravated Humidity @ 95%
Material Substance Compliance	RoHS Compliant CE & UKCA Compliant - Antenna

GLOBAL 4G, 5G, CBRS CELLULAR COVERAGE

The FP20 auto antenna family provides truly global cellular coverage. The table below shows the frequencies and bands covered and the performance across these bands is shown in the charts below via the corresponding color.

FREQUENCY	RF BANDS COVERED
617-698 MHz	71
698-960 MHz	5, 6, 8, 12, 13, 14, 17, 18, 19, 20, 26, 27, 28, 29, 44, 67, 68, 85 N5, N8, N12, N14, N18, N20, N28, N29, N81, N82, N83, N89, N91, N92, N93, N94
1427-1511 MHz	11, 21, 32, 45, 74 N50, N51, N74, N75, N76
1690-2700 MHz	1, 2, 3, 4, 7, 9, 10, 15, 16, 23, 25, 30, 33, 34, 35, 36, 37, 38, 39, 40, 41, 65, 66, 69, 70 N30, N34, N38, N39, N40, N41, N65, N66, N70, N80, N84, N86, N90, N95
3300-4200 MHz	22, 42, 43, 48 N48, N77, N78
4400-6000 MHz	N79
6000-7125 MHz*	46, 47 N96, N102, N104

4G, 5G, CBRS CELLULAR PERFORMANCE

TYPICAL VSWR

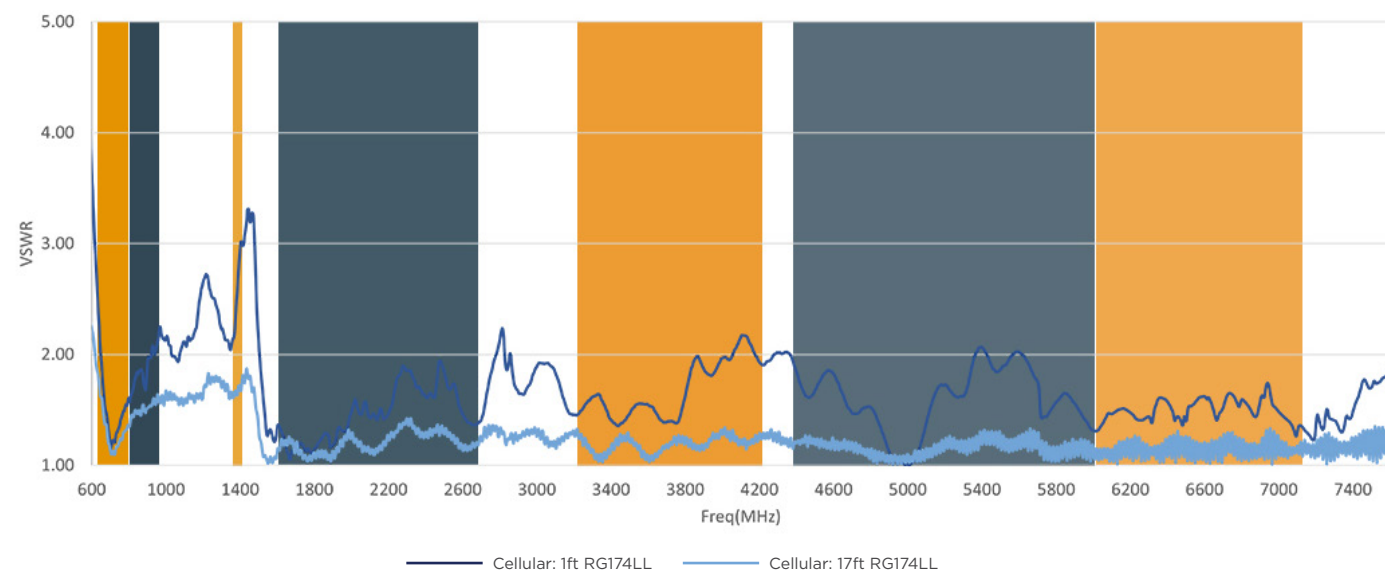

4G, 5G, CBRS CELLULAR PERFORMANCE

GAIN MAX (DBI)

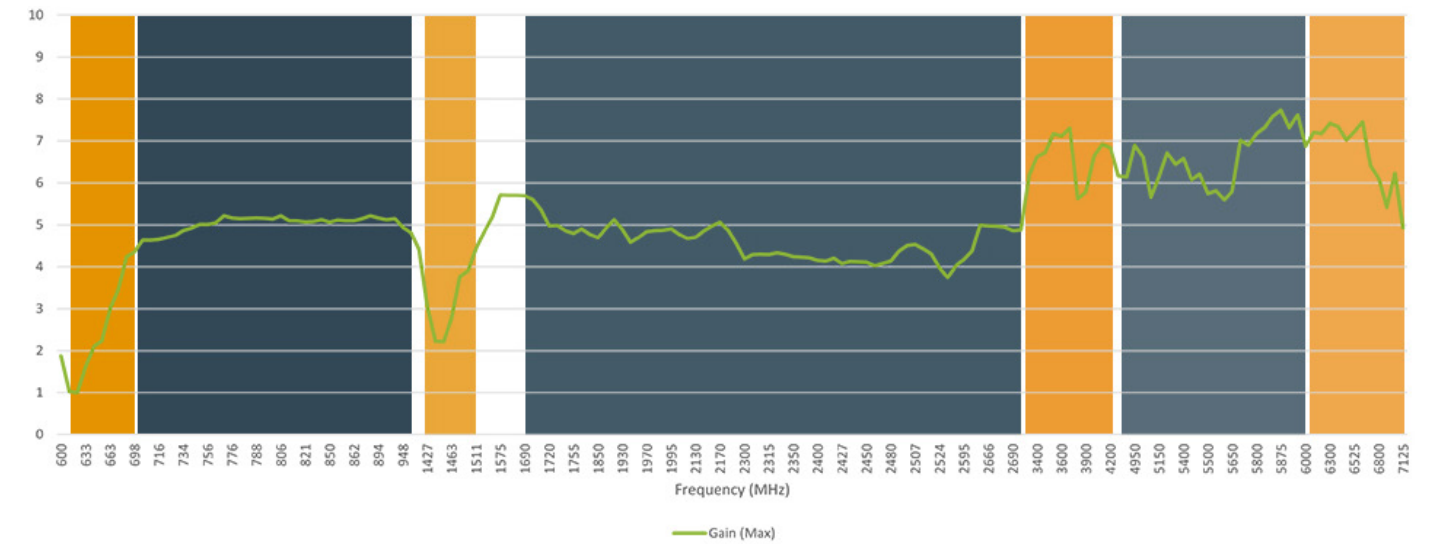

AVERAGE EFFICIENCY %

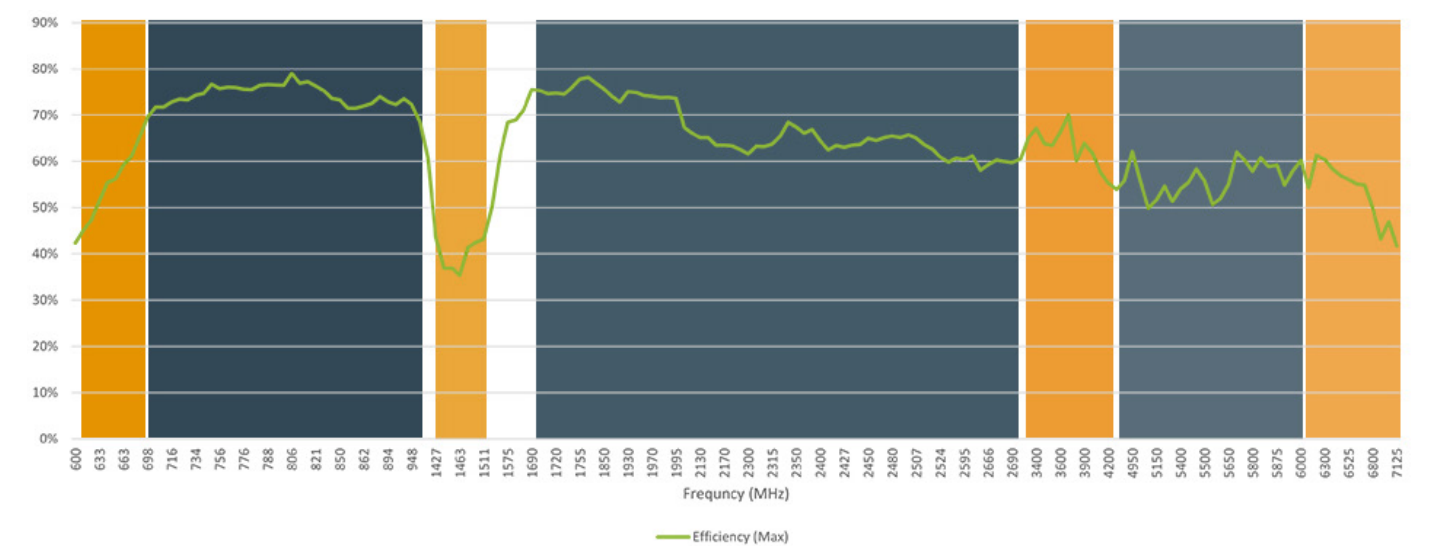

WI-FI AND BLUETOOTH PERFORMANCE

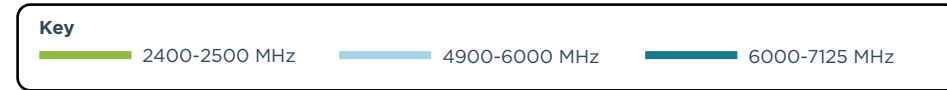

TYPICAL VSWR - WI-FI

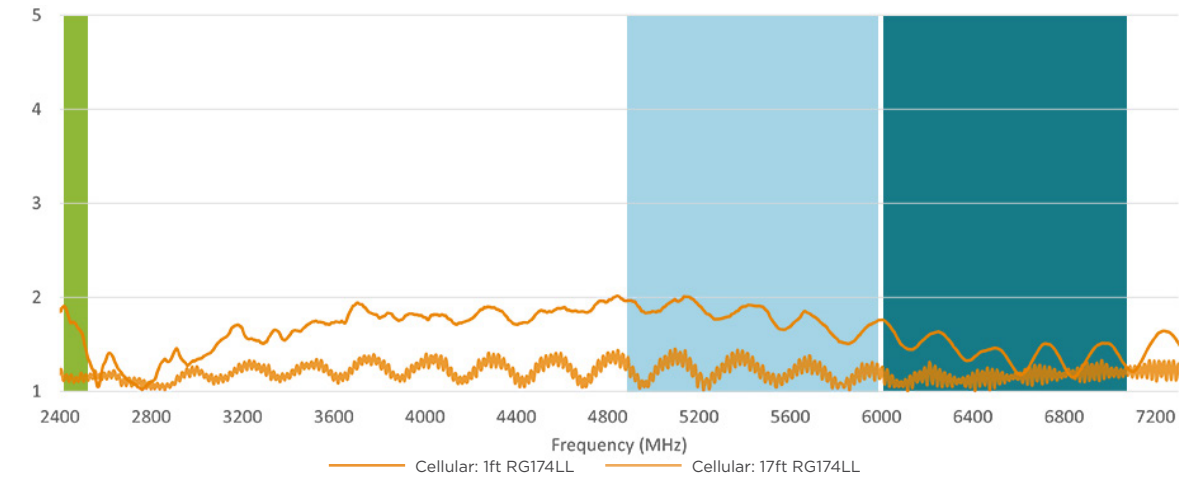

GAIN MAX (DBI) - WI-FI

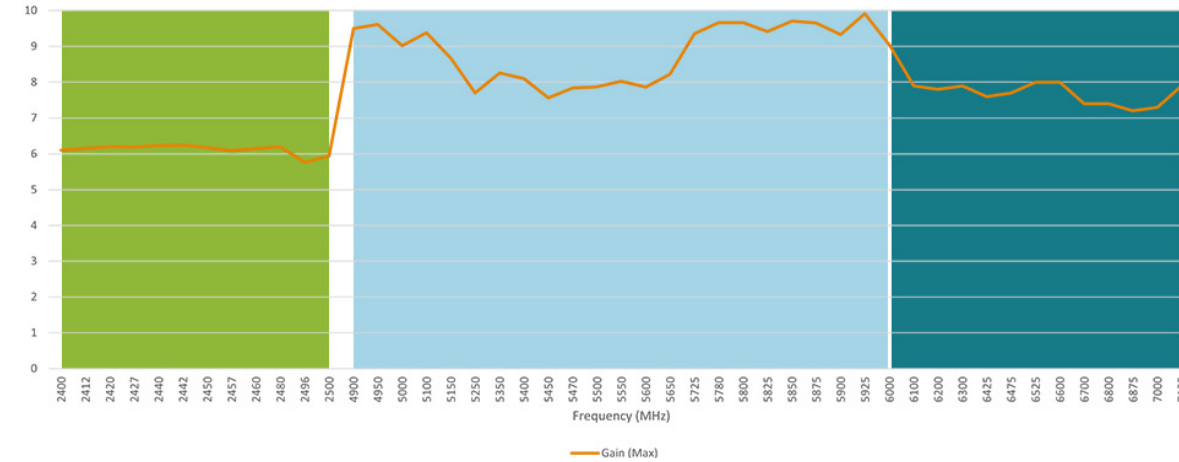

AVERAGE EFFICIENCY - WI-FI

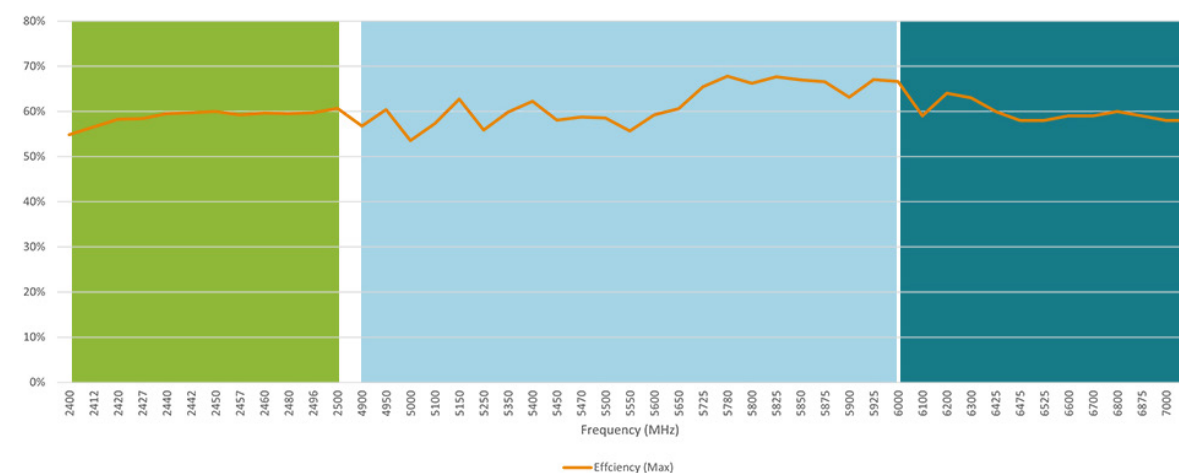

RADIATION PATTERNS

The patterns below are representative of the typical performance of all **FP20 auto** antenna models. Patterns are recorded without the extension cable added and are two element (cellular) or up to four element (Wi-Fi) simulated composite data. Please contact us for full test data. These antennas will perform on and off a ground plane. Performance may vary slightly when no ground plane is used in conjunction with these antennas. If you require test data for both scenarios please get in touch.

4G/5G/CBRS (CELLULAR)

Radiation Patterns at 617 MHz

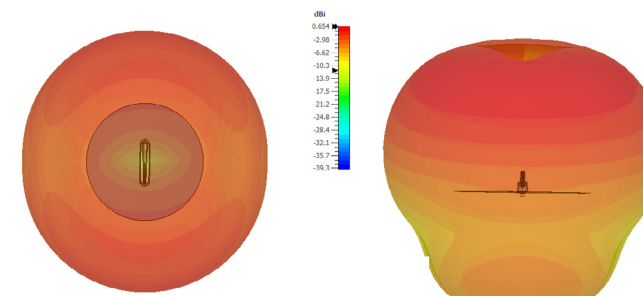

Radiation Patterns at 698 MHz

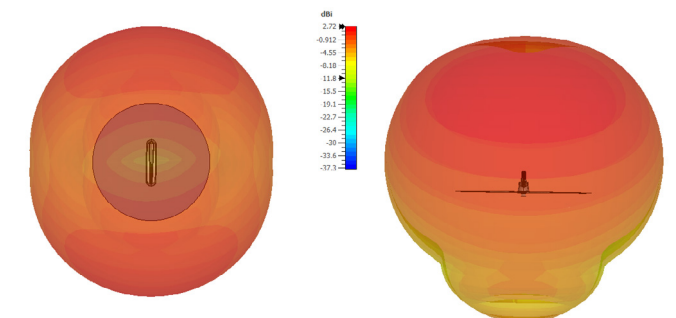

Radiation Patterns at 850 MHz

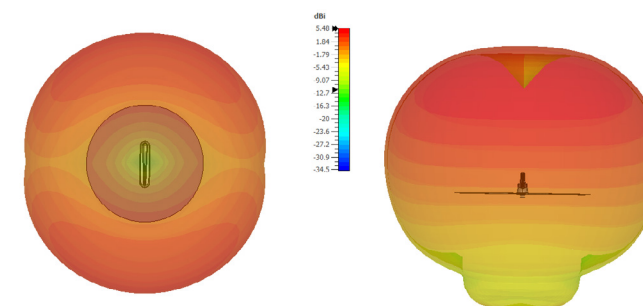

Radiation Patterns at 960 MHz

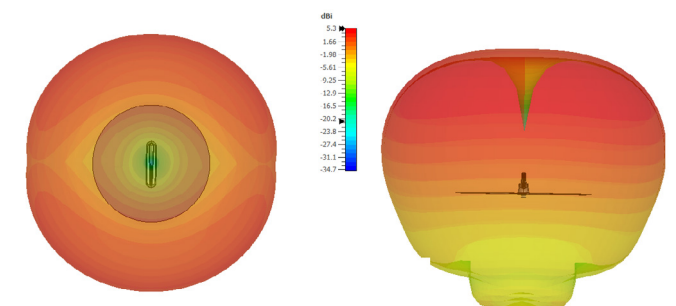

Radiation Patterns at 1500 MHz

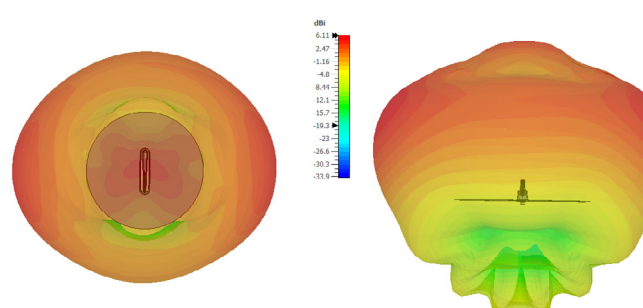

Radiation Patterns at 1690 MHz

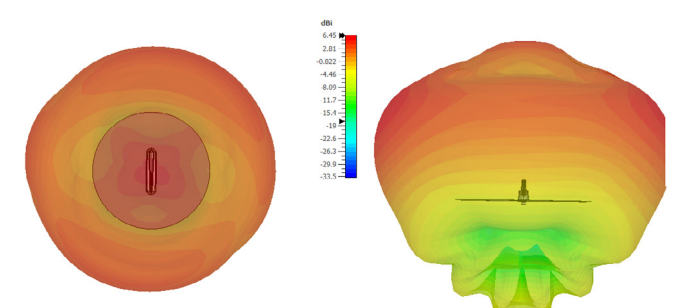

Radiation Patterns at 2170 MHz

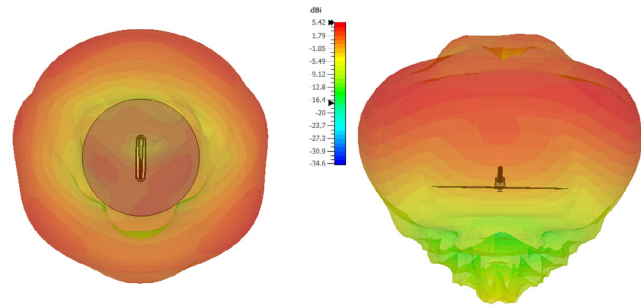

Radiation Patterns at 2500 MHz

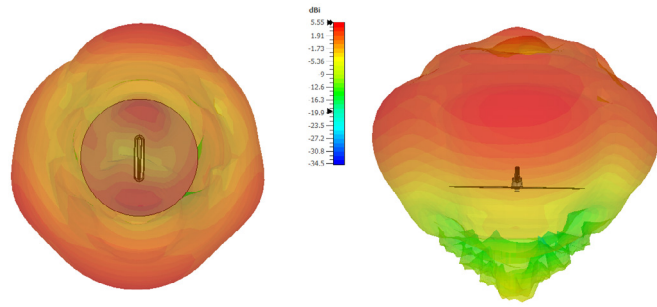

Radiation Patterns at 2700 MHz

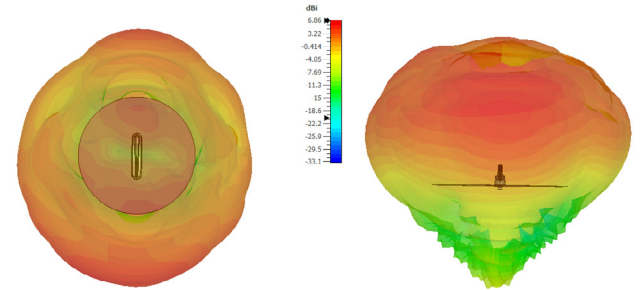

Radiation Patterns at 3500 MHz

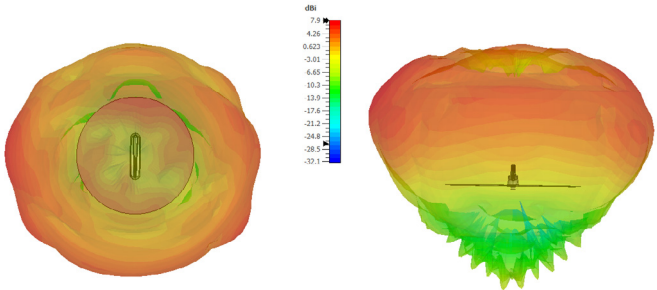

Radiation Patterns at 4900 MHz

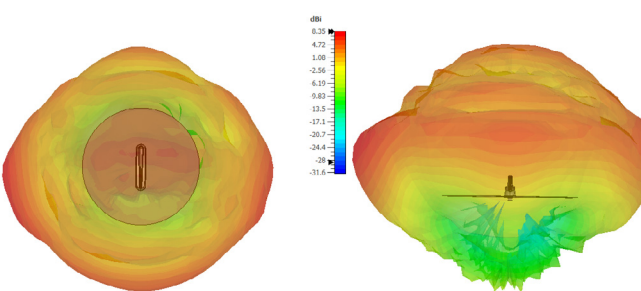

Radiation Patterns at 6000 MHz

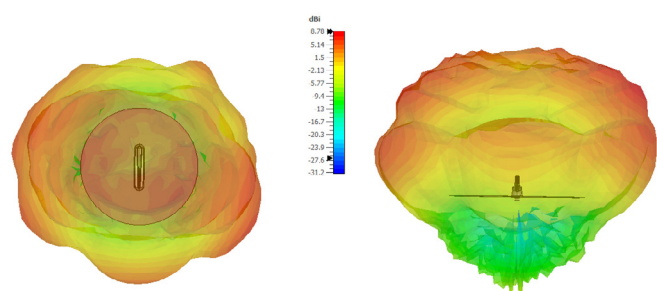

Radiation Patterns at 7125 MHz

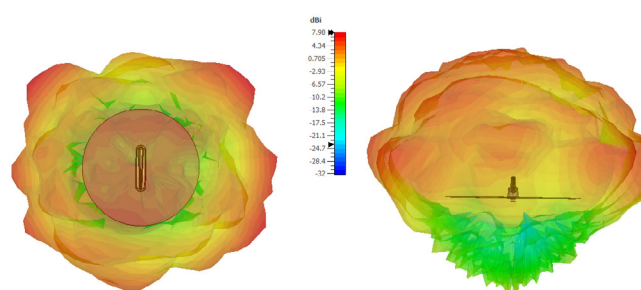

WI-FI 6E/7 & BLUETOOTH

Radiation Patterns at 2400 MHz

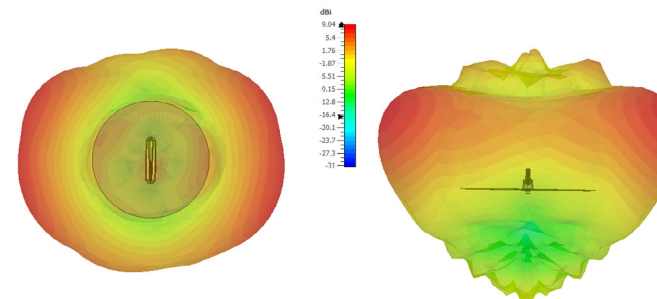

Radiation Patterns at 2450 MHz

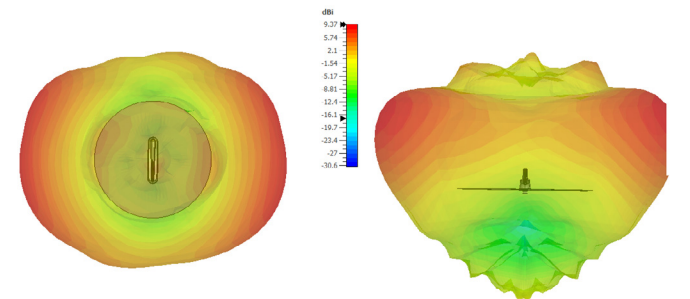

Radiation Patterns at 2500 MHz

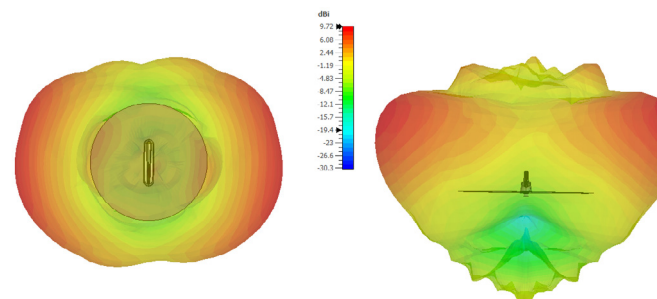

Radiation Patterns at 4900 MHz

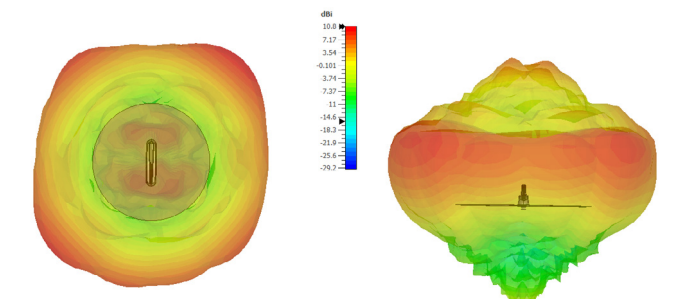

Radiation Patterns at 5500 MHz

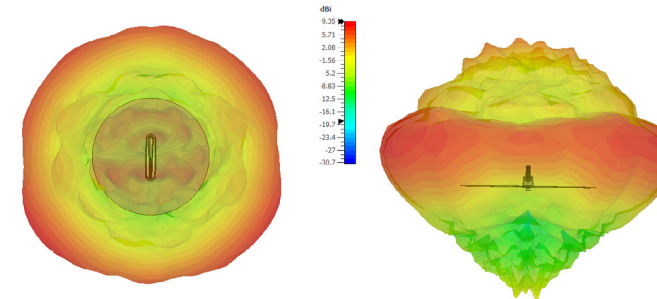

Radiation Patterns at 6000 MHz

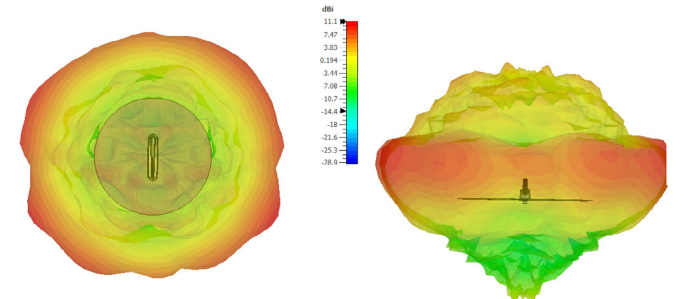

Radiation Patterns at 7125 MHz

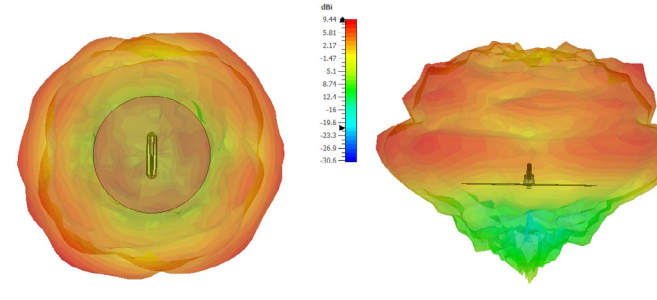

FP20 AUTO: DRAWINGS - SIX PORT

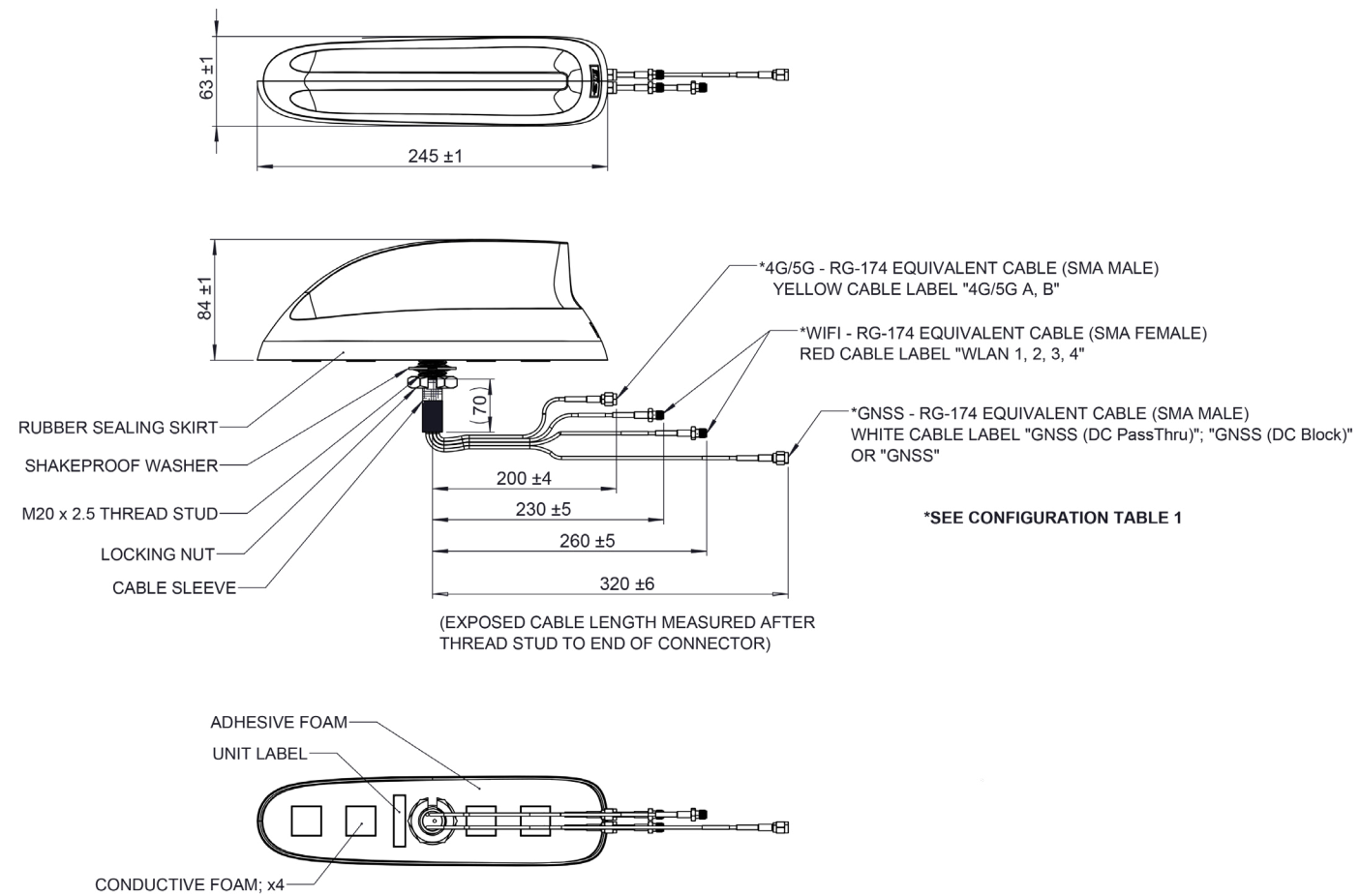

Six Port (No Whip Model)

FP20 AUTO: DRAWINGS - (INC. WHIP MODELS)

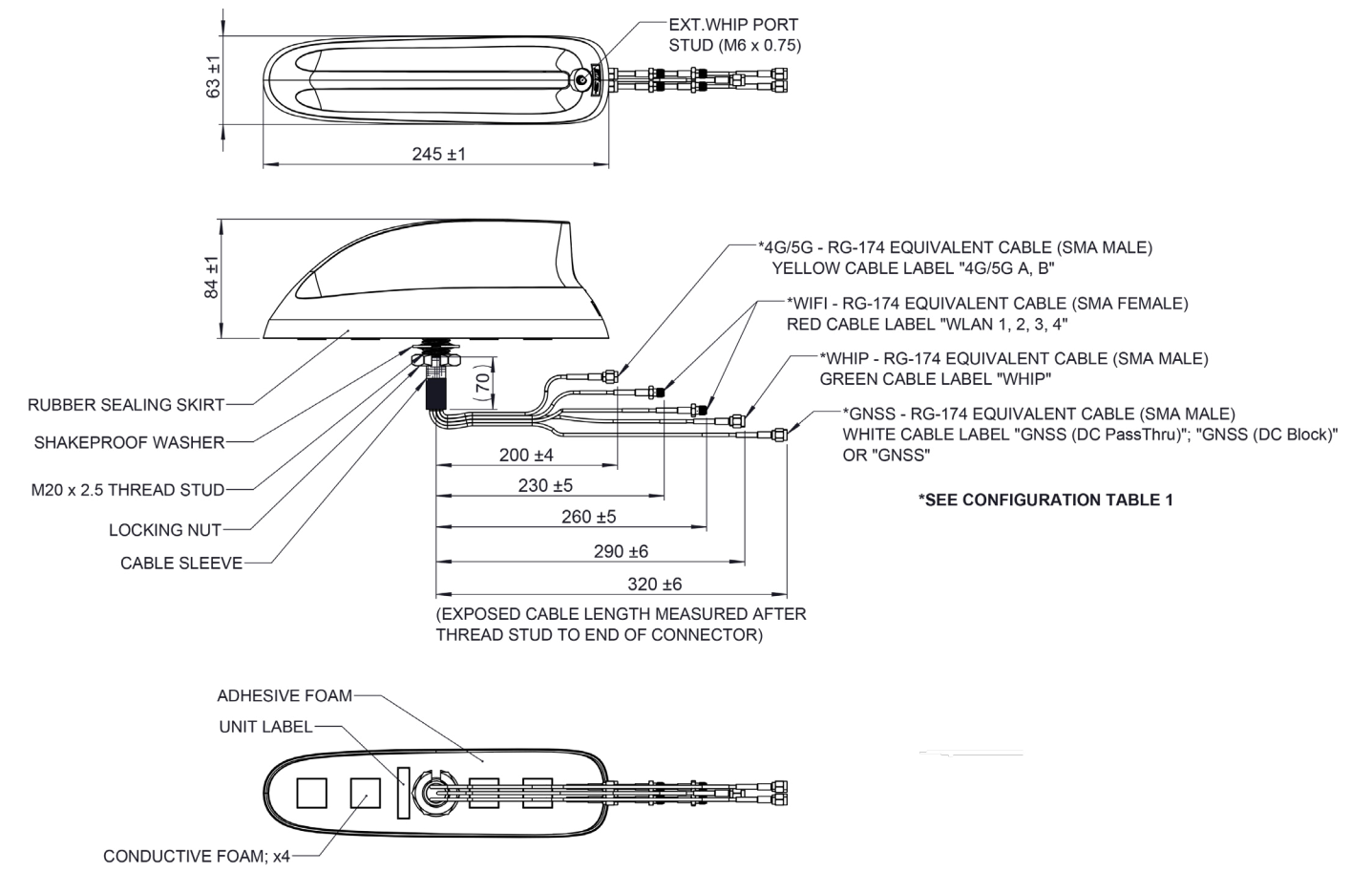

6, 7, 8 & 9 Port (Inc. Whip Models)

FP20 AUTO: DRAWINGS (WITH WHIP)

Illustrative Whip Placement (Tri-Band Whip Shown - Part No. L000340-01)

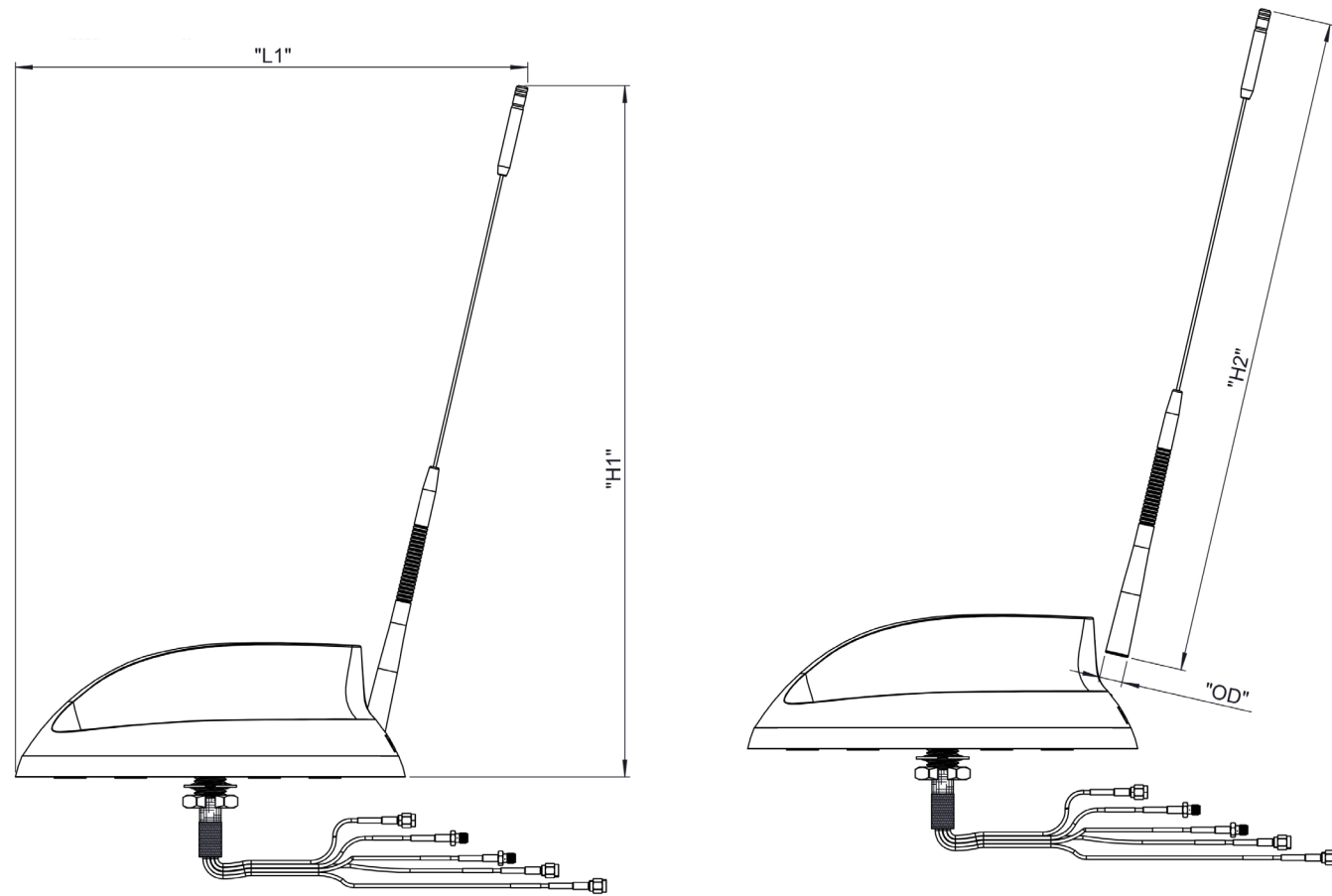

PACKAGING

FP20 auto antennas will be shipped with the appropriate extension cable, in the kit configurations on pages 4-5 of this document. Extension cables will be pre-fitted to the antenna pigtail to reduce installation time.

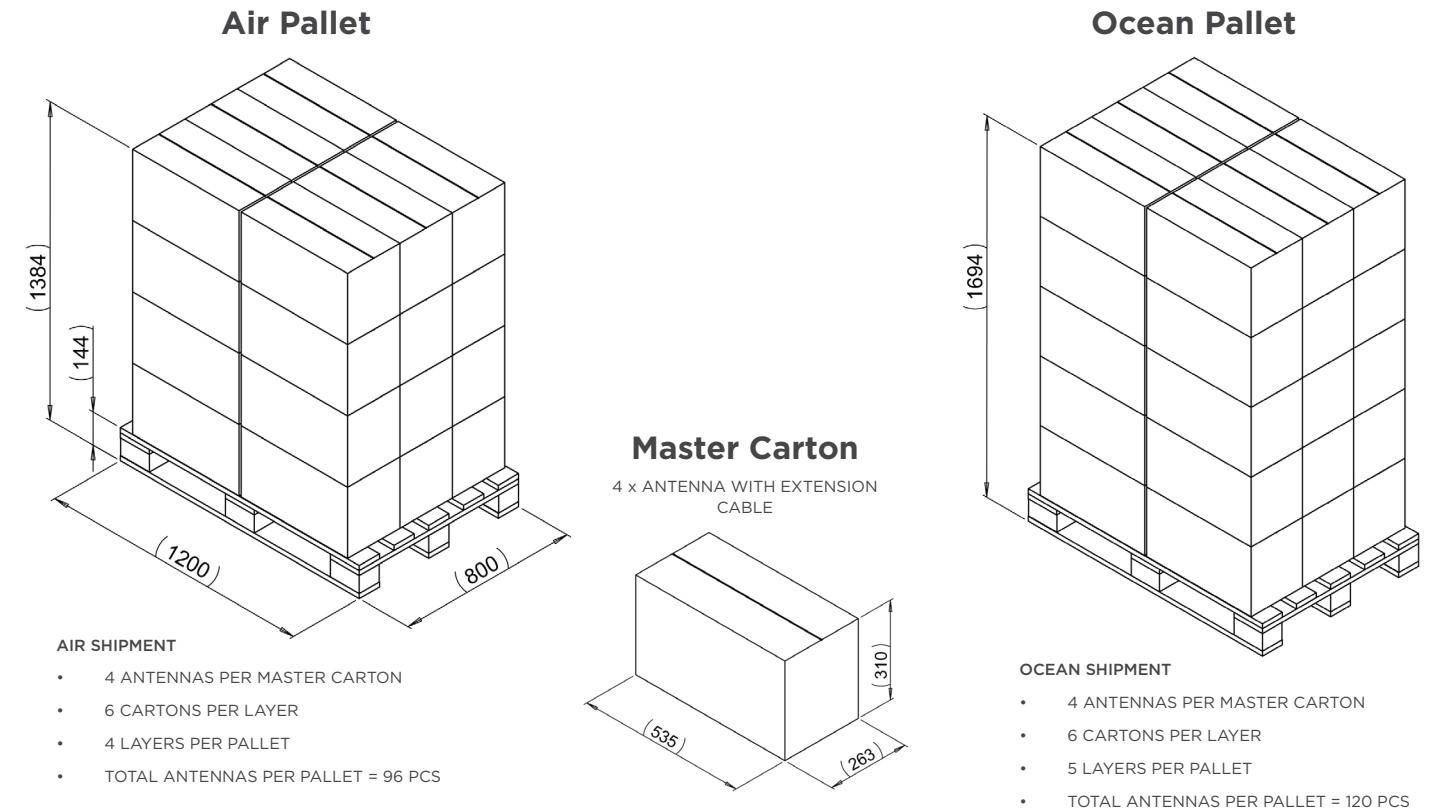

Kit Part Number	Description	Estimated Master Carton @ 4 Unit Antenna weight (Kg)	Estimated Full Pallet Weight (Air Shipment)(Kg)	Estimated Full Pallet Weight (Ocean Shipment)(Kg)
L000423-01	6 Port: 2 x Cellular, 3 x Wi-Fi, 1 x GNSS	8.3	211	261
L000423-02	7 Port: 2 x Cellular, 2 x Wi-Fi, 2 x GNSS, 1 x Whip	9.06	230	284
L000423-03	7 Port: 2 x Cellular, 2 x Wi-Fi, 2 x GNSS, 1 x Whip	9.06	230	284
L000423-04	8 Port: 2 x Cellular, 4 x Wi-Fi, 1 x GNSS, 1 x Whip	9.9	250	309
L000423-05	9 Port: 2 x Cellular, 4 x Wi-Fi, 2 x GNSS, 1 x Whip	10.7	269	333
L000423-06	9 Port: 2 x Cellular, 4 x Wi-Fi, 2 x GNSS, 1 x Whip	10.7	269	333
L000423-07	6 Port: 2 x Cellular, 2 x Wi-Fi, 1 x GNSS, 1 x Whip	8.3	211	261
L000423-08	5 Port: 2 x Cellular, 2 x Wi-Fi, 1 x GNSS	7.1	183	225
L000423-09	6 Port: 2 x Cellular, 2 x Wi-Fi, 1 x GNSS, 1 x Whip	8.3	211	261
L000423-10	5 Port: 2 x Cellular, 2 x Wi-Fi, 1 x GNSS	7.1	183	225
L000423-11	7 Port: 2 x Cellular, 3 x Wi-Fi, 1 x GNSS, 1 x Whip	9.06	230	284
L000423-12	8 Port: 2 x Cellular, 3 x Wi-Fi, 2 x GNSS, 1 x Whip	9.9	250	309
L000423-13	7 Port: 2 x Cellular, 2 x Wi-Fi, 2 x GNSS, 1 x Whip	9.06	230	284

FP20 AUTO: APPLICATIONS

The examples below are intended to demonstrate just some of the scenarios and applications where **FP20 auto** antennas may be used. There are many more possible scenarios and applications. If you are in any doubt about whether this is the correct antenna for your use, please contact us.



Emergency Services & Public Safety

Emergency services and public safety agencies around the world have an ever increasing need for high bandwidth data connectivity with applications such as: **dashcam footage; live video streaming; ANPR; facial recognition; finger print analysis** etc..



Public Transportation

Onboard connectivity is not only common but expected nowadays. In fact after arriving on time, a passenger's second concern is likely to be whether they can stream their favorite music and shows on the move. Other than **onboard Wi-Fi**, applications for public transportation can also include: **ticketing** (digital payments or apps); **navigation systems; security cameras; dispatch control; vehicle diagnostics** etc.



Utility & Repair Vehicles

Utility and repair vehicles often utilize a wide variety of connectivity in order to operate effectively including devices communicating with the vehicle through Wi-Fi, cloud uploads via 5G and location through GNSS. These requirements can be seen in the: **diagnostic equipment; augmented reality (AR); live video streaming; software updates; and positioning/location services** used on a daily basis.

te.com

TE Connectivity, TE Connectivity (logo) and Every Connection Counts are trademarks. All other logos, products and/or company names referred to herein might be trademarks of their respective owners.

The information given herein, including drawings, illustrations and schematics which are intended for illustration purposes only, is believed to be reliable. However, TE Connectivity makes no warranties as to its accuracy or completeness and disclaims any liability in connection with its use. TE Connectivity's obligations shall only be as set forth in TE Connectivity's Standard Terms and Conditions of Sale for this product and in no case will TE Connectivity be liable for any incidental, indirect or consequential damages arising out of the sale, resale, use or misuse of the product. Users of TE Connectivity products should make their own evaluation to determine the suitability of each such product for the specific application.

©2022 TE Connectivity. All Rights Reserved.

11/22a Original

TECHNICAL SUPPORT CENTER

USA: +1 (800) 522-6752

Canada: +1 (905) 475-6222

Mexico: +52 (0) 55-1106-0800

Latin/S. America: +54 (0) 11-4733-2200

Germany: +49 (0) 6251-133-1999

UK: +44 (0) 800-267666

France: +33 (0) 1-3420-8686

Netherlands: +31 (0) 73-6246-999

China: +86 (0) 400-820-6015