

# AXICOM P2 RELAY V23079

## SIGNAL RELAYS

### FEATURES

- Standard telecom relay (ringing and test access)
- Slim line 15x7.5mm (.590x.295")
- Max. Switching current 2A
- 2 form C bifurcated contacts (2 changeover contacts, 2 CO)
- Immersion cleanable
- High sensitivity for low power consumption 140mW/ 70mW

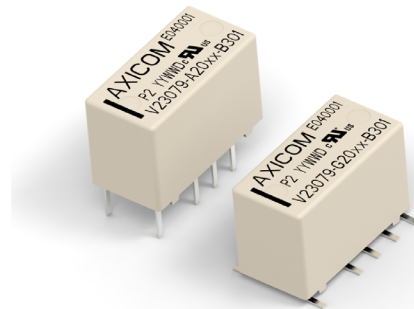

### APPLICATIONS

- Communications equipment linecard application (ringing and test access)
- PABX
- Voice over IP
- Office equipment
- Measurement and control equipment
- Automotive equipment as CAN bus
- Keyless entry
- Speaker switch
- Medical equipment
- Consumer electronics
- Set top boxes
- HiFi

### APPROVALS

- UL61810-1 (former UL508) No. 214025



Technical data of approved types on request.

# Axicom P2 Relay V23079

Signal Relays

## CONTACT DATA

Contact arrangement	2 form C (CO)
Max. switching voltage	220 VDC, 250 VAC
Rated current	2 A
Limiting continuous current, 85 °C	2 A
Switching Power	60 W, 62.5 VA
Contact material	AgNi, gold-covered
Contact style	bifurcated contact
Minimum switching voltage	100 $\mu$ V
Thermoelectrical potential	<10 $\mu$ V
Initial contact resistance	<50 m $\Omega$ at 10 mA, 20 mV
Frequency of operation, without load	50 operations/s
Operate time	typ. 2 ms, max. 4 ms
Set/reset time	typ. 2 ms, max. 4 ms
Release time	
Without diode in parallel	typ. 2ms, max. 4ms
With diode in parallel	typ. 4ms, max. 6ms
Bounce time	typ. 1ms, max. 3ms

Electrical endurance	
at 12V / 10mA	typ. 5x10 <sup>7</sup> operations
at 6V / 100mA	typ. 1x10 <sup>7</sup> operations
at 60V / 500mA	typ. 5x10 <sup>5</sup> operations
at 30V / 1000mA	typ. 1x10 <sup>6</sup> operations
at 30V / 2000mA	typ. 2x10 <sup>5</sup> operations
at 12V / 5000mA / 25°C	typ. 1x10 <sup>5</sup> operations
Contact ratings, UL	110 VDC / 0.3 A - 33 W 30 VDC / 2.0 A - 60 W 120 VAC / 0.5 A - 60 VA 240 VAC / 0.25 A - 60 VA 125 VAC / 1 A NO Side 125 VDC / 0.5 A NO Side
Mechanical endurance	typ. 10x10 <sup>6</sup> operations

## MAX. DC LOAD BREAKING CAPACITY

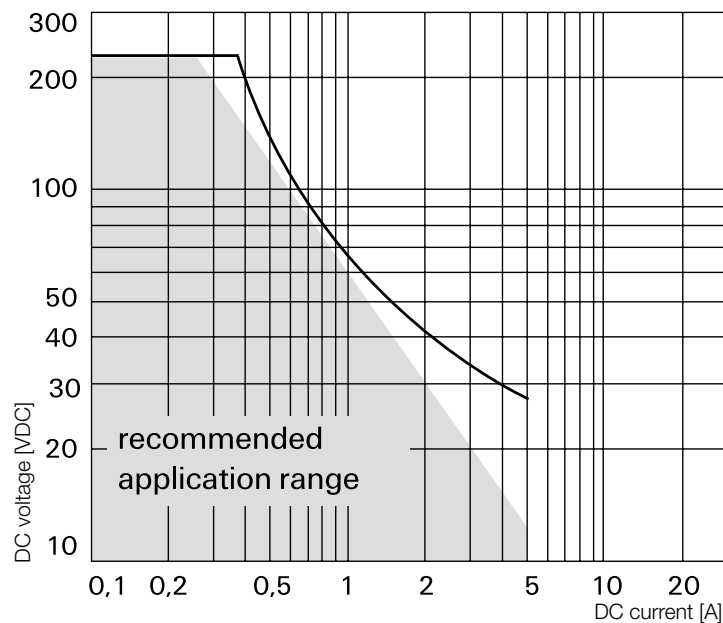

# Axicom P2 Relay V23079

Signal Relays

## COIL DATA

Magnetic system	polarized
Coil voltage range	2 to 24VDC
Max. coil temperature	105°C
Thermal resistance 3.2	< 125K/W

## COIL VERSIONS, DC-COIL

Coil code	Rated voltage VDC	Operate voltage VDC	Limiting voltage VDC	Release voltage VDC	Coil resistance $\Omega \pm 10\%$	Rated coil power mW
<b>Coil versions, monostable</b>						
008	3.00	2.25	6.50	0.30	64	140
016	4.00	3.00	8.70	0.40	114	140
011	4.50	3.38	9.80	0.45	145	140
001	5.00	3.75	10.90	0.50	178	140
002	6.00	4.50	13.00	0.60	257	140
006	9.00	6.75	19.60	0.90	578	140
003	12.00	9.00	26.15	1.20	1029	140
005	24.00	18.00	52.30	2.40	4114	140
<b>Coil versions, bistable, 1 coil</b>						
108	3.00	2.25	9.2	-2.25	128	70
111	4.50	3.38	13.85	-3.38	289	70
101	5.00	3.75	15.33	-3.75	357	70
102	6.00	4.50	18.5	-4.50	514	70
106	9.00	6.75	27.75	-6.75	1157	70
103	12.00	9.00	37	-9.00	2057	70
105	24.00	18.00	74	-18.00	8228	70
<b>Coil versions, bistable, 2 coil</b>						
219	2.00	1.50	4.33	1.50	28	140
218	2.40	1.80	5.2	1.80	41	140
208	3.00	2.25	6.5	2.25	64	140
211	4.50	3.38	9.8	3.38	145	140
201	5.00	3.75	10.9	3.75	178	140
202	6.00	4.50	13	4.50	257	140
206	9.00	6.75	19.6	6.75	578	140
203	12.00	9.00	26.15	9.00	1029	140
205	24.00	18.00	52.3	18.00	4114	140

All figures are given for coil without pre-energization, at ambient temperature +23 °C. Other coil voltages on request.

## COIL VERSIONS, MONOSTABLE

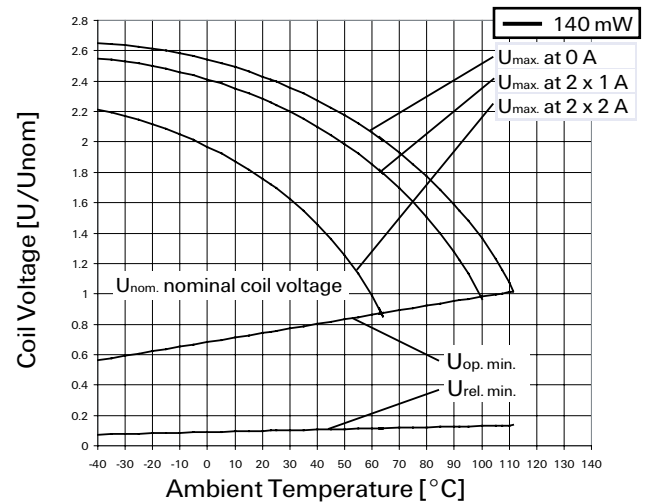

## COIL VERSIONS, BISTABLE

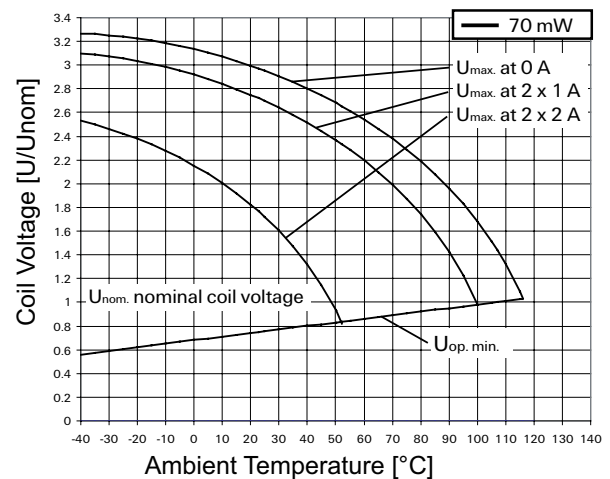

# Axicom P2 Relay V23079

Signal Relays

Coil code	Rated voltage VDC	Operate voltage VDC	Limiting voltage VDC	Release voltage VDC	Coil resistance $\Omega \pm 10\%$	Rated coil power mW
<b>Coil versions, high dielectric version, monostable, overmolded</b>						
008	3.00	2.25	6.1	0.30	45	200
001	5.00	3.75	10.1	0.50	125	200
002	6.00	4.50	12.1	0.60	180	200
006	9.00	6.75	18.2	0.90	405	200
003	12.00	9.00	24.2	1.20	720	200

All figures are given for coil without pre-energization, at ambient temperature +23 °C. Other coil voltages on request.

## INSULATION DATA

	Standard	HDV
Initial dielectric strength		
Between open contacts	1000Vrms	1500Vrms
Between contact and coil	1500Vrms	1500Vrms
Between adjacent contacts	1000 Vrms	1500Vrms
Initial surge withstand voltage		
Between open contacts	2000Vrms	2500Vrms
Between contact and coil	2500Vrms	2500Vrms
Between adjacent contacts	2500 Vrms	2500Vrms
Capacitance		
between open contacts	max. 1pF	
between contact and coil	max. 2pF	
between adjacent contacts	max. 1.5pF	
Clearance /creepage	1.3/2.5mm	

## COIL VERSIONS, HIGH DIELECTRIC VERSION, MONOSTABLE, OVERMOLDED

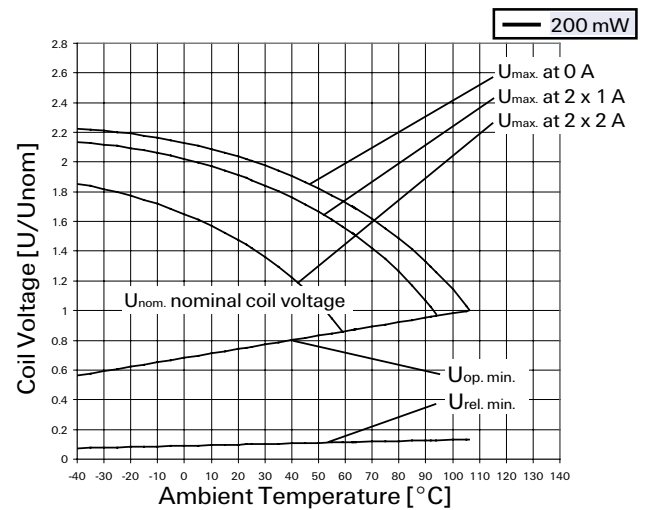

## OTHER DATA

Material compliance	EU RoHS/ELV, China RoHS, REACH, Halogen content refer to the Product Compliance Support Center at <a href="http://www.te.com/customer-support/rohssupportcenter">www.te.com/customer-support/rohssupportcenter</a>
Ambient temperature	-40 to +85 °C
Category of environmental protection	
IEC 61810	RT III - wash tight
Vibration resistance (functional)	35g, 10 to 1000Hz
Shock resistance (functional)	
IEC 60068-2-27 (half sine)	100 g
Terminal type	PCB-THT SMT long and short terminals
Weight	max. 2.8 g
Resistance to soldering heat THT	
IEC 60068-2-20	265 °C/ 10 s
Moisture sensitive level, JEDEC J-Std-020E Related to SMT relays and THT relays packed in reel	MSL3
Ultrasonic cleaning	not recommended
Packaging/unit	
THT	tubes/2000 pcs.
THT	reel/1500 pcs.
SMT	reel/2000 pcs. or 2500 pcs.

# Axicom P2 Relay V23079

Signal Relays

## TERMINAL ASSIGNMENT

TOP view on component side of PCB

Monostable version

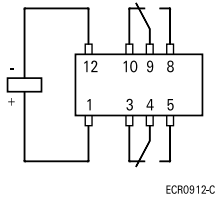

Bistable version, 1-coil

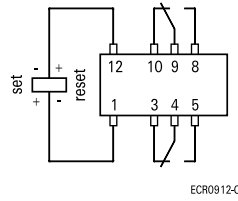

Bistable version, 2-coils

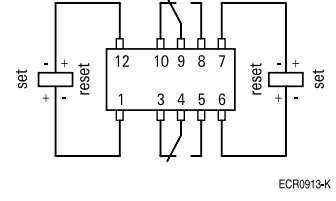

**Note:** Contacts are shown in reset condition. Both coils can be used as either set or reset coils. Contact position might change during transportation and must be reset before use.

## PCB LAYOUT

TOP view on component side of PCB

THT version

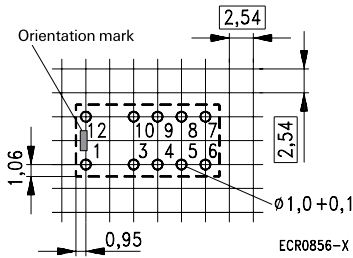

SMT, long terminals

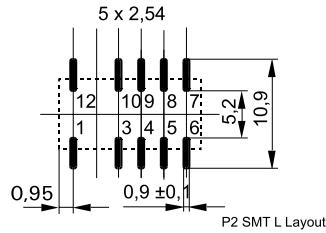

SMT, short terminals

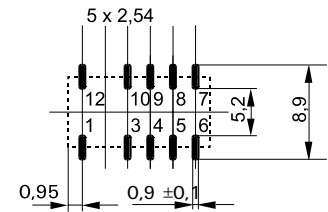

## DIMENSIONS (Unit: mm)

Overmolded coil, high dielectric version

THT version

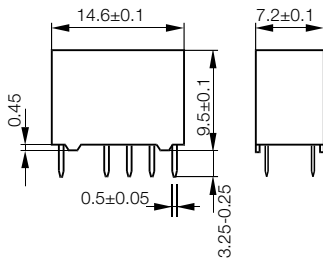

SMT, long terminals

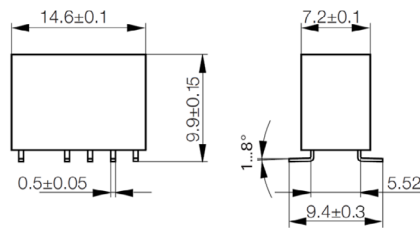

SMT, short terminals

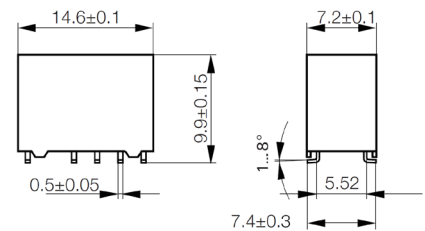

# Axicom P2 Relay V23079

Signal Relays

## PROCESSING

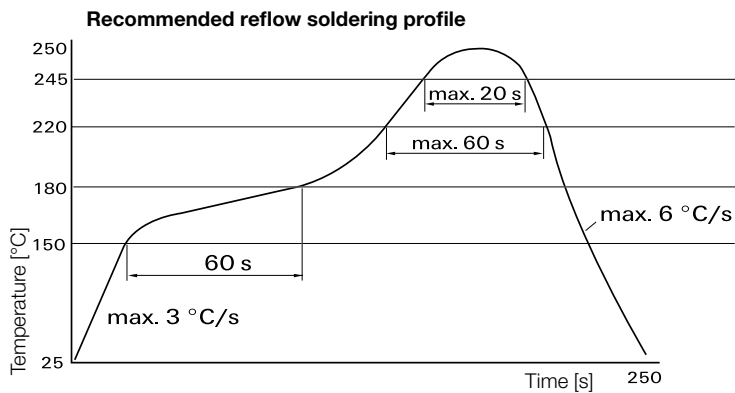
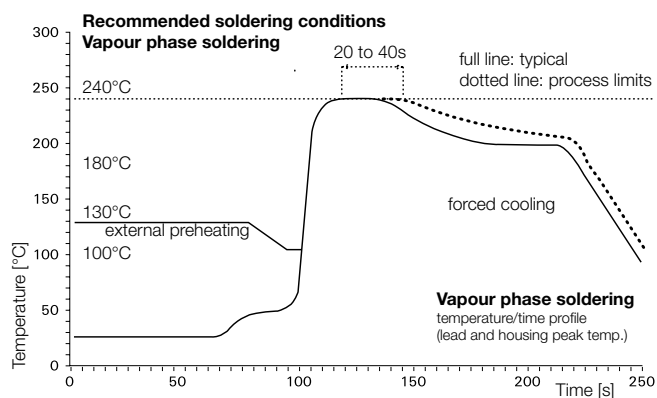

## PACKING

### THT-tubes

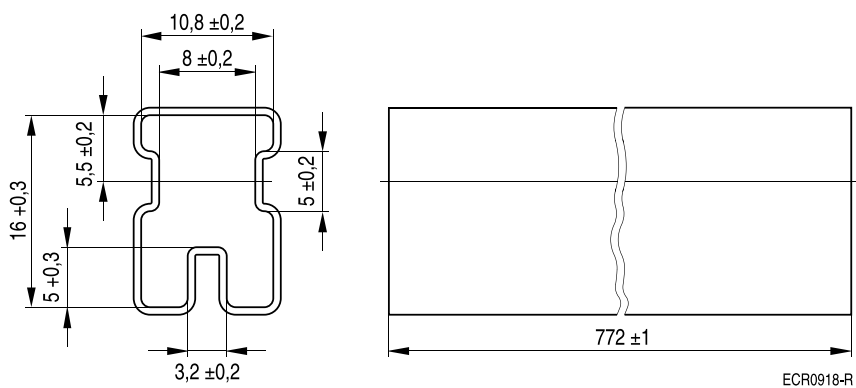

## REEL DIMENSIONS

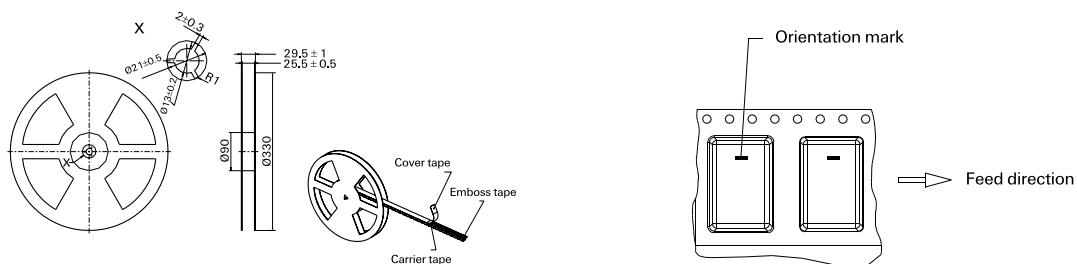

# Axicom P2 Relay V23079

Signal Relays

## SMT - Long terminals

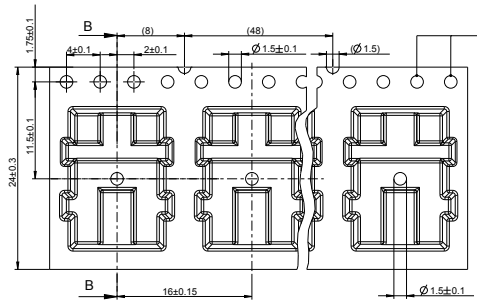

distance of transport holes 1.5  
 4x10-40±0.2mm  
 4x11-44±0.2mm  
 4x12-48±0.2mm

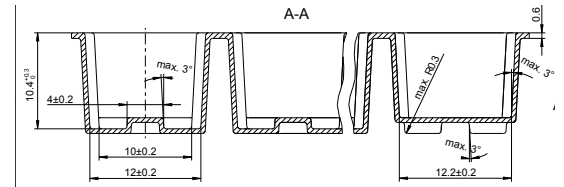
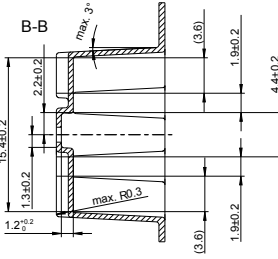

## SMT - Short terminals

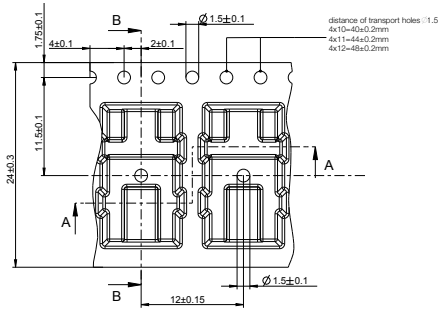

distance of transport holes 1.5  
 4x10-40±0.2mm  
 4x11-44±0.2mm  
 4x12-48±0.2mm

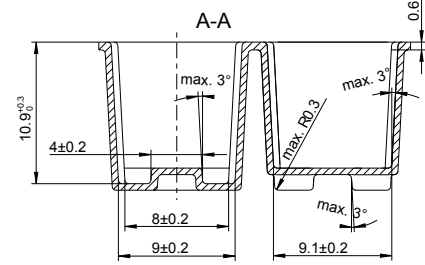
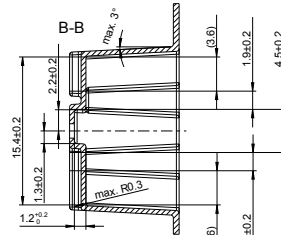

## THT - Reel

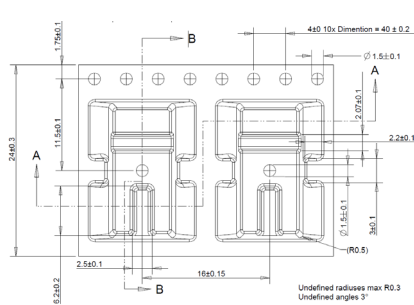

Undefined radiuses max R0.3  
 Undefined angles 3°

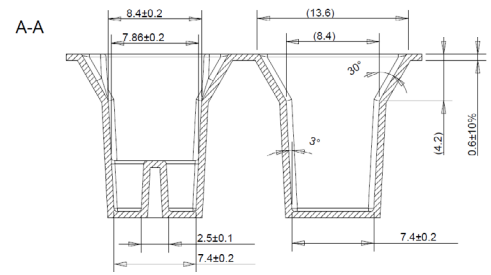
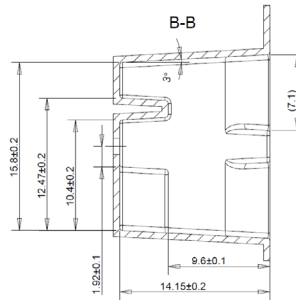

# Axicom P2 Relay V23079

Signal Relays

## ORDERING INFORMATION

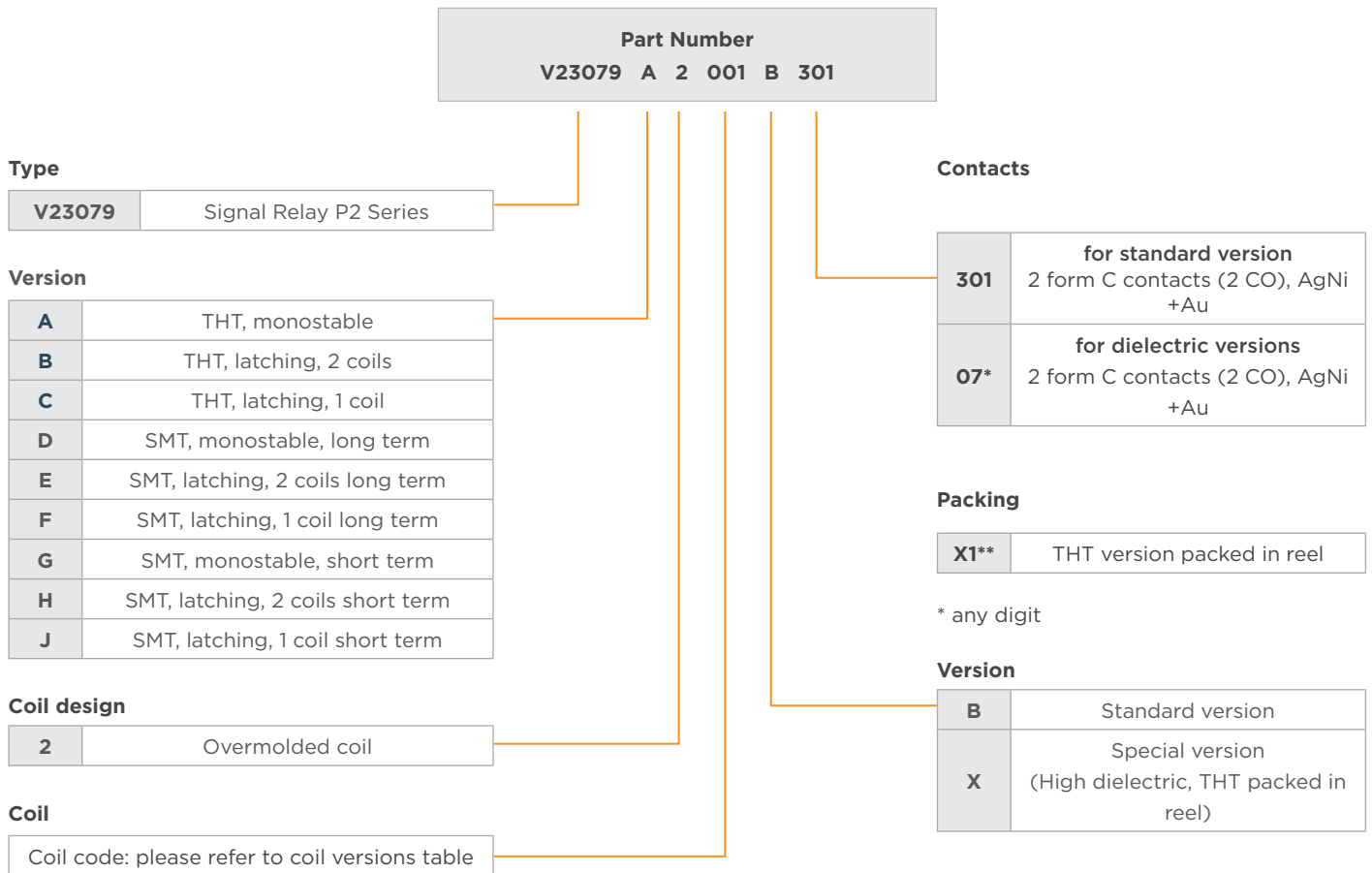

## PRODUCT INFORMATION

Product code	Version	Coil design	Coil type	Coil voltage	Part number
V23079-A2008-B301	THT	Overmolded	Monostable	3VDC	<a href="#">6-1419120-6</a>
V23079-A2011-B301				4.5VDC	<a href="#">3-1393789-9</a>
V23079-A2001-B301				5VDC	<a href="#">3-1393789-5</a>
V23079-A2002-B301				6VDC	<a href="#">3-1393789-6</a>
V23079-A2006-B301				9VDC	<a href="#">3-1393789-8</a>
V23079-A2003-B301				12VDC	<a href="#">3-1393789-7</a>
V23079-A2005-B301				24V	<a href="#">1-1422025-0</a>
V23079-A2016-B301				4V	<a href="#">1393790-3</a>
V23079-B2219-B301			Bistable, 2 coils	2VDC	<a href="#">1-1422002-2</a>
V23079-B2218-B301				2.4VDC	<a href="#">1-1422002-1</a>
V23079-B2208-B301				3VDC	<a href="#">1-1422002-0</a>
V23079-B2201-B301				5VDC	<a href="#">1422002-9</a>
V23079-B2211-B301				4.5VDC	<a href="#">1-1422002-7</a>



# Axicom P2 Relay V23079

## Signal Relays

Product code	Version	Coil design	Coil type	Coil voltage	Part number			
V23079-B2202-B301	THT	Overmolded	Bistable 1coil	6VDC	<a href="#">2-1422008-2</a>			
V23079-B2206-B301				9VDC	<a href="#">2-1422008-6</a>			
V23079-B2203-B301				12VDC	<a href="#">3-1422008-6</a>			
V23079-B2205-B301				24VDC	<a href="#">3-1422008-7</a>			
V23079-C2108-B301				3VDC	<a href="#">8-1422008-3</a>			
V23079-C2111-B301				4.5VDC	tbd			
V23079-C2101-B301				5VDC	<a href="#">4-1422008-5</a>			
V23079-C2102-B301				6VDC	tbd			
V23079-C2106-B301				9VDC	tbd			
V23079-C2103-B301				12VDC	tbd			
V23079-D2008-B301				SMT, long pins	Overmolded	Monostable	3VDC	<a href="#">4-1393789-7</a>
V23079-D2011-B301	4.5VDC	<a href="#">4-1393789-8</a>						
V23079-D2001-B301	5VDC	<a href="#">4-1393789-3</a>						
V23079-D2002-B301	6VDC	<a href="#">4-1393789-4</a>						
V23079-D2006-B301	9VDC	<a href="#">4-1393789-6</a>						
V23079-D2003-B301	12VDC	<a href="#">4-1393789-5</a>						
V23079-D2016-B301	4VDC	<a href="#">1393790-4</a>						
V23079-D2005-B301	24VDC	<a href="#">5-1422008-5</a>						
V23079-E2219-B301	Bistable, 2 coils	2VDC	<a href="#">1422007-6</a>					
V23079-E2201-B301		5VDC	<a href="#">1422007-7</a>					
V23079-E2206-B301		9VDC	<a href="#">6-1422008-9</a>					
V23079-E2208-B301		3VDC	<a href="#">1422007-8</a>					
V23079-E2218-B301		2.4VDC	<a href="#">1422007-9</a>					
V23079-E2211-B301		4.5V	<a href="#">1-1422007-6</a>					
V23079E2205B301		24VDC	<a href="#">5-1422008-9</a>					
V23079E2203B301		12VDC	<a href="#">1-1422007-5</a>					
V23079F2108B301		SMT long pins	Overmolded			Bistable 1coil	3VDC	<a href="#">8-1422008-6</a>
V23079F2111B301							4.5VDC	<a href="#">8-1422008-1</a>
V23079F2101B301	5VDC						<a href="#">1-1422008-5</a>	
V23079F2106B301	9VDC						<a href="#">1-1422008-6</a>	
V23079F2103B301	12VDC			tbd				
V23079F2105B301	24VDC			tbd				
V23079-G2008-B301	SMT, short pins			Overmolded	Monostable	3VDC	<a href="#">5-1393789-4</a>	
V23079-G2016-B301						4VDC	<a href="#">1393790-5</a>	
V23079-G2011-B301						4.5VDC	<a href="#">5-1393789-5</a>	
V23079-G2001-B301						5VDC	<a href="#">4-1393789-9</a>	
V23079-G2002-B301						6VDC	<a href="#">5-1393789-0</a>	
V23079-G2006-B301		9VDC	<a href="#">5-1393789-3</a>					
V23079-G2003-B301		12VDC	<a href="#">5-1393789-1</a>					

Product code	Version	Coil design	Coil type	Coil voltage	Part number	
V23079-G2008-X079	SMT short pins	High dielectric Overmolded	Monostable	3VDC	<a href="#">1422006-5</a>	
V23079-G2001-X071				5VDC	<a href="#">1422006-1</a>	
V23079-G2002-X072				6VDC	<a href="#">1422006-2</a>	
V23079-G2006-X073				9VDC	<a href="#">1422006-3</a>	
V23079-G2003-X074				12VDC	<a href="#">1422006-4</a>	
V23079-A2003-X074				THT	12VDC	<a href="#">1422025-7</a>
V23079-A2008-X079					3VDC	<a href="#">1-1422025-1</a>
V23079-H2208-B301	SMT short pins	Overmolded	Bistable 2coil	3VDC	tbd	
V23079-H2211-B301				4.5VDC	tbd	
V23079-H2201-B301				5VDC	tbd	
V23079-H2202-B301				6VDC	tbd	
V23079-H2206-B301				9VDC	tbd	
V23079-H2203-B301				12VDC	tbd	
V23079-H2218-B301				2.VDC	<a href="#">2-1422007-0</a>	
V23079-H2205-B301	24VDC		tbd			
V23079-J2108-B301	SMT short pins		Bistable 1coil	3VDC	tbd	
V23079-J2111-B301				4.5VDC	tbd	
V23079-J2101-B301				5VDC	tbd	
V23079-J2102-B301				6VDC	tbd	
V23079-J2103-B301				12VDC	tbd	
V23079-J2105-B301				24VDC	tbd	
V23079-A2008-X101	THT packed in reel	Monostable	3VDC	<a href="#">6-1419170-9</a>		
V23079-A2011-X102			4.5VDC	<a href="#">3-1393790-1</a>		
V23079-A2001-X103			5VDC	<a href="#">3-1393790-2</a>		
V23079-A2002-X104			6VDC	<a href="#">3-1393790-3</a>		
V23079-A2006-X105			9VDC	<a href="#">3-1393790-4</a>		
V23079-A2003-X106		12VDC	<a href="#">3-1393790-5</a>			
V23079-B2219-X107		Bistable, 2 coils	2VDC	<a href="#">1-1422003-0</a>		
V23079-B2218-X108			2.4VDC	<a href="#">1-1422003-1</a>		
V23079-B2208-X109			3VDC	<a href="#">1-1422003-2</a>		
V23079-B2201-X110			5VDC	<a href="#">1422003-3</a>		
V23079-C2108-X100			Bistable 1coil	3VDC	<a href="#">5-1393790-1</a>	

te.com

©2024 TE Connectivity Ltd. All Rights Reserved.

TE Connectivity, SCHRACK, TE connectivity (logo) and Every Connection Counts are trademarks owned or licensed by the TE Connectivity Ltd. family of companies. All other logos, products and/or company names referred to herein might be trademarks of their respective owners.

While TE has made every reasonable effort to ensure the accuracy of the information in this document, TE does not guarantee that it is error-free, nor does TE make any other representation, warranty or guarantee that the information is accurate, correct, reliable or current. TE reserves the right to make any changes to the information contained herein without prior notice. TE Connectivity assumes only those obligations set forth in the terms and conditions for this product and shall in no event be liable for any incidental, indirect, or consequential damages arising out of the sale, resale, use, or misapplication of the product. TE expressly disclaims any implied warranties with respect to the information contained herein, including, but not limited to, implied warranties of merchantability or fitness for a particular purpose. Dimensions, specifications and/or information contained herein are for reference purposes only and are subject to change without notice. Consult TE for the latest dimensions, specifications and/or information. Users of TE Connectivity products must make their own assessment as to whether the respective product is suitable for the respective desired application.

06/24 ED