

SCHRACK MINIATURE PCB RELAY PE BISTABLE

GENERAL PURPOSE LOW POWER PCB RELAYS

INTRODUCTION

TE Connectivity (TE)'s Miniature Power PCB Relays PE bistable is general purpose relay designed for various types of loads (e.g., resistive, inductive) with low component height. The relay is designed as 1 pole 5A with contact variant 1 form C (CO) and as 1 pole 6A with contact variant 1 form A (NO). Bistable relays maintain their switching position after the energization or input voltage is disconnected.

Other advantages include: high initial dielectric strength, high temperature resistance and sensitive coil.

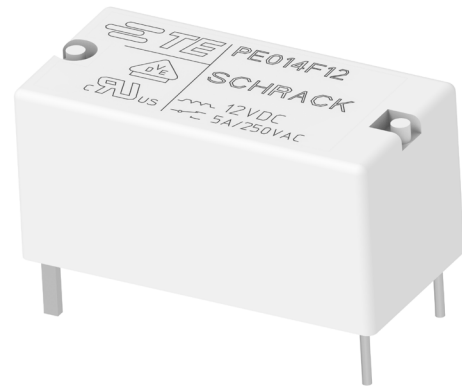

FEATURES

- Polarized bistable version
- 1 pole 5 A, 1 form C (CO) or 6A, 1 form A (NO) contact
- Sensitive version with 200mW coil
- Ambient temperature 70°C
- Low height 10.0mm
- Plastic materials according to IEC 60335-1 (domestic appliances)

APPLICATIONS

- Room thermostats
- Electricity meters
- Home automation
- White goods
- Battery powered controls

APPROVALS

- VDE Cert. No. 40011901 (for AgNi90/10 contacts only)
- UL E214025

Technical data of approved types on request



SCHRACK Miniature PCB Relay PE bistable

General Purpose | Low Power PCB Relays

CONTACT DATA

Contact arrangement	1 form C (CO) or 1 form A (NO)
Rated voltage	250VAC
Max. switching voltage	400VAC
Rated current	5A (CO - types) 6A (NO - AgNi - types)
Breaking capacity max.	1250VA (CO - types) 1500VA (NO AgNi - types)
Contact material	AgNi 90/10, AgSnO ₂ AgNi 90/10 HTV (gold plated)
Frequency of operation, with/without load	360/72000 ops/h
Set/reset time	typ. 8/8ms
Bounce time, form A/form B	4/7ms

CONTACT RATINGS

Type	Contact	Load	Cycles
IEC 61810			
PE014	C (CO)	5A, 250VAC, $\cos\phi=1$, 85°C	100x10 ³
PE014	A (NO)	5A, 30VDC, 0 ms, 85°C	100x10 ³
PE034	NO	6A, 250VAC $\cos\phi=1$, 70°C	20x10 ³
UL61810-1 (UL 508)			
PE013	C (CO)	5A, 240VAC, resistive, 85°C	30x10 ³
PE014	NO (of CO)	B300	6.000
PE514	NO (of CO)	R300	6.000
PE514	C (CO)	5A, 250VAC, general purpose, 85°C	6.000
PE033	N (NO)	5A, 240VAC, resistive, 85°C	50x10 ³
PE014	C/A/B	5A, 250VAC, resistive, 85°C	100x10 ³
PE034	A (NO)	6A, 250VAC, resistive, 70°C	100x10 ³
Mechanical endurance		>5x10 ⁶ operations	

MAX. DC LOAD BREAKING CAPACITY

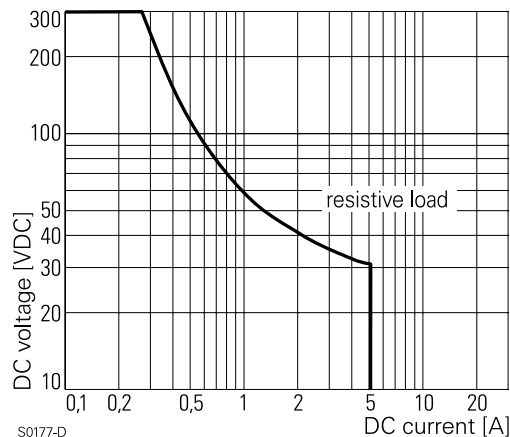

S0177-D

ELECTRICAL ENDURANCE

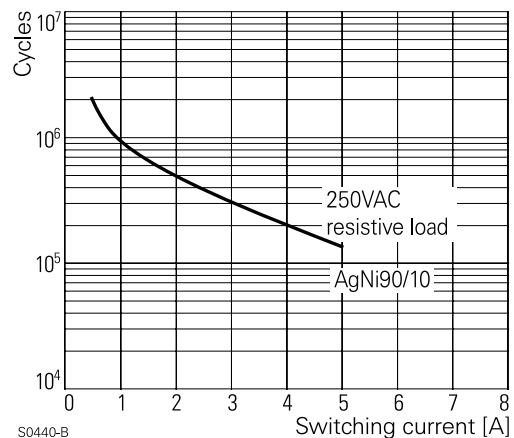

COIL DATA

Magnetic system	bistable, polarized
Coil voltage range	2.2 to 48VDC
Operative range, IEC 61810	2
Reset voltage max., % of rated coil voltage	120% at -40°C
Min./Max. energization duration	20ms ¹⁾ /1min at <10% duty factor

1) Information on reduced pulse duration with higher energization voltages on demand.

COIL VERSIONS, DC COIL

Coil code ²⁾	Rated voltage VDC	Set voltage VDC	Reset voltage VDC	Coil resistance $\Omega \pm 10\%$	Rated coil power mW
F02 H02	2.2	1.65	1.65	22	220
F03 H03	3	2.25	2.25	41	220
F05 H05	5	3.75	3.75	125	200
F06 H06	6	4.5	4.5	180	200
F12 H12	12	9.0	9.0	650	222
F24 H24	24	18.0	18.0	2750	209

2) Coil codes F.. and H.. have opposite polarity; refer to coil operation table. All figures are given for coil without pre-energization, at ambient temperature +23°C. Other coil voltages on request.

COILS - OPERATION

Version	F..		H..	
Coil terminals	A1	A2	A1	A2
Operate	+	-	-	+
Reset	-	+	+	-
Contact position not defined at delivery				

SCHRACK Miniature PCB Relay PE bistable

General Purpose | Low Power PCB Relays

COIL OPERATING RANGE

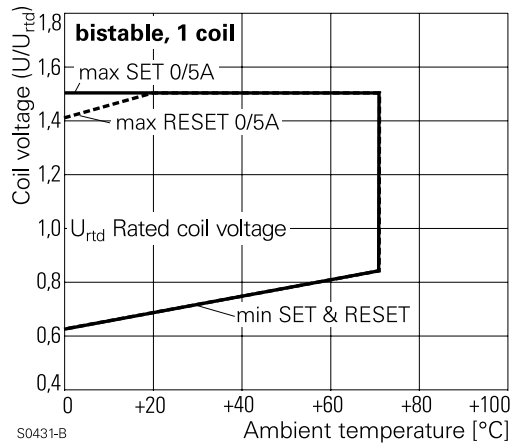

INSULATION DATA

Initial dielectric strength	
Between open contacts	1000V _{rms}
Between contact and coil	4000V _{rms}
Initial insulation resistance	
Open contact circuit	>10x10 ⁹ Ω
Coil-contact circuit	>10x10 ⁹ Ω
Clearance/creepage	
Between contact and coil	≥3.2/4mm
Material group of insulation parts	IIIa
Tracking index of relay base	PTI250V

PCB LAYOUT / TERMINAL ASSIGNMENT

Bottom view on solder pins

1 form C (CO) version

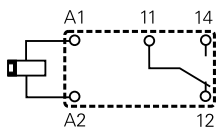
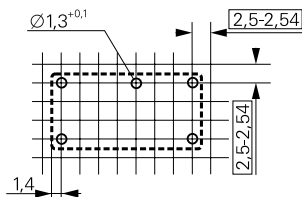

1 form A (NO) version

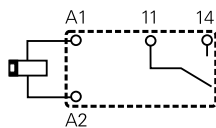
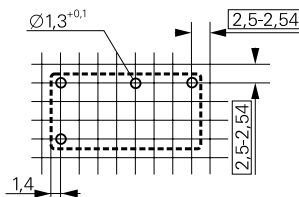

OTHER DATA

Material compliance	EU RoHS/ELV, China RoHS, REACH, Halogen content refer to the Product Compliance Support Center at www.te.com/customersupport/rohssupportcenter
Resistance to heat and fire	according EN60335, par.30
Ambient temperature	-40 to 85°C 70°C at 100% duty factor
Category of environmental protection	
IEC 61810	RTII - flux proof RTIII - wash tight on request
Shock resistance (destructive)	>100g
Shock resistance (functional/ 11ms), form A/ form B	>15/5g
Terminal type	PCB-THT
Weight	5g
Resistance to soldering heat THT	
IEC 60068-2-20	260°C/10s (flux proof version) 260°C/5s (wash tight version)
Packaging/unit	tube/25 pcs., box/500 pcs.

DIMENSIONS

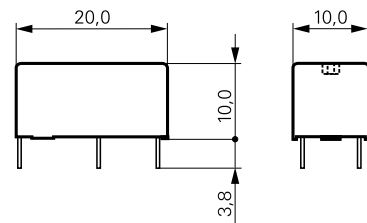

PRODUCT CODE STRUCTURE

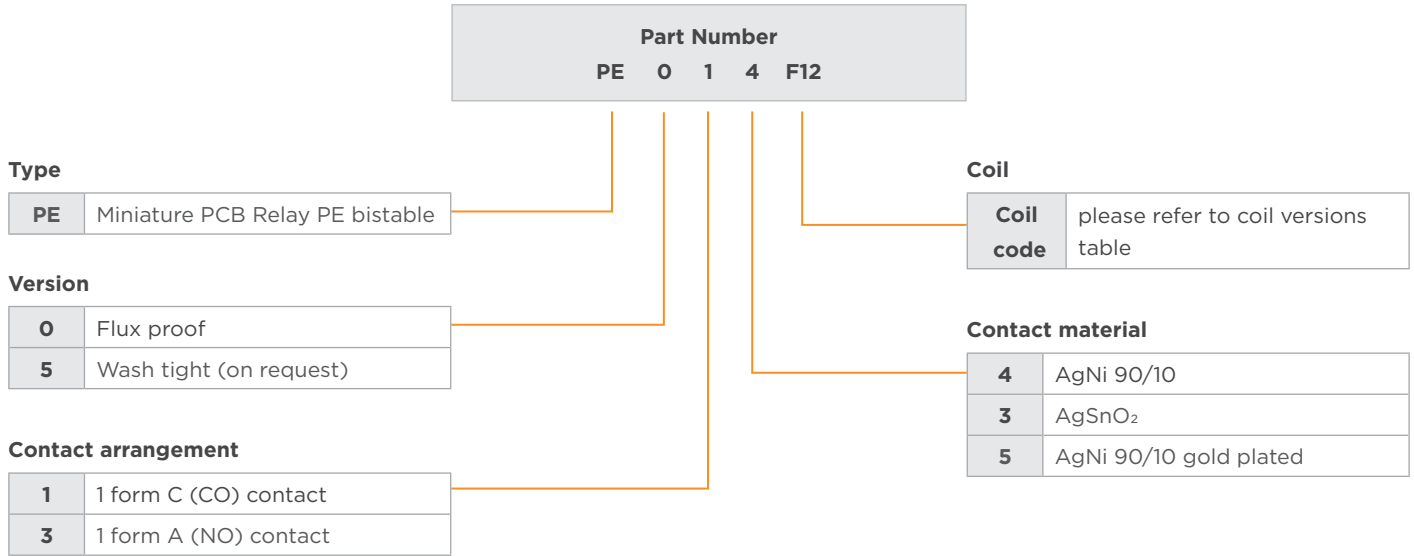

PRODUCT INFORMATION

Product code	Version	Contacts	Contact material	Coil	TE Part Number
PE514F03	wash tight	1 form C 1 CO contact	AgNi 90/10	bistable polarity F	2-1415539-0
PE014F02	flux proof				9-1415389-1
PE014F03					1415390-1
PE014F05					1-1415390-1
PE014F06					2-1415390-1
PE014F12					3-1415390-1
PE014F24					5-1415390-1
PE014H02				bistable polarity H	7-1415390-1
PE014H03	8-1415390-1				
PE014H05	9-1415390-1				
PE014H06	1415391-1				
PE014H12	1-1415391-1				
PE014H24	2-1415391-1				
PE015F05	1 form C				AgNi 90/10 HTV
PE034F09	1 form A 1 NO contact	AgNi 90/10	1415543-7		
PE034F12			1415544-4		

te.com

©2023 TE Connectivity Ltd. family of companies. All Rights Reserved.

TE Connectivity, TE connectivity (logo) and Every Connection Counts are trademarks owned or licensed by the TE Connectivity family of companies. All other logos, products and/or company names referred to herein might be trademarks of their respective owners.

While TE has made every reasonable effort to ensure the accuracy of the information in this document, owned or licensed by the TE Connectivity family of companies. TE does not guarantee that it is error-free, nor does TE make any other representation, warranty or guarantee that the information is accurate, correct, reliable or current. TE reserves the right to make any changes to the information contained herein without prior notice. TE Connectivity assumes only those obligations set forth in the terms and conditions for this product and shall in no event be liable for any incidental, indirect, or consequential damages arising out of the sale, resale, use, or misapplication of the product. TE expressly disclaims any implied warranties with respect to the information contained herein, including, but not limited to, implied warranties of merchantability or fitness for a particular purpose. Dimensions, specifications and/or information contained herein are for reference purposes only and are subject to change without notice. Consult TE for the latest dimensions, specifications and/or information. Users of TE Connectivity products must make their own assessment as to whether the respective product is suitable for the respective desired application.

08/23 ED