

# LUMAWISE MOTION PROGRAMMABLE

## Street Lighting Motion Sensor

The LUMAWISE Motion Programmable motion sensor is designed for streetlighting. Enabling energy savings from dimming the luminaire, while still being able to react to motion and bring a luminaire to full brightness for safety and security reasons.

LUMAWISE Motion Programmable motion sensor will fit into the Zhaga-D4i ecosystem, the new standard in smart cities. Working as a standalone control device or in combination with Zhaga-D4i photocell or communication node for greater levels of control.

This programmable version of LUMAWISE Motion sensor allows a user to self-define parameters like brightness levels, on time and ambient light on and off levels.

### BENEFITS

- Interoperability guaranteed from the Zhaga-D4i logo and certification
- Detected motion will cause a dimmed luminaire to brighten supporting energy savings while still having the safety and security of a lit area
- Compact design to keep the aesthetics of modern designed luminaires
- One handed easy under luminaire connection supports an installer to work below the luminaire

### APPLICATIONS

- Street lighting
- Park, recreational and walkway lighting
- Cycle ways
- Station lighting
- High bay lighting



Zhaga-D4i certified

# LUMAWISE Motion Programmable

## Street lighting Motion Sensor

### FEATURES

- Programmable version is configurable via the DALI bus
- 30mx6m rectangular detection zone (@5m height)
- Ø10m circular detection zone (@5m height)
- Default parameters
  - On: 35lux, Off: 18lux
  - No motion: 20% brightness, motion: 100% brightness
  - On time: 2 minutes
- Tested on poles from 5 to 12m high
- Motion detected from PIR sensor
- Detects pedestrians, wheelchair users, runners and cyclists
- Masks available for self-defined detection zone
- Lighting control of the driver from the D4i communication protocol
- Zhaga book 18 interface (4 position connection)
- Zhaga-D4i Type B device, with application controller
- Polarity insensitive DALI input
- IP66, IP68 and IK07
- -40°C to 65°C operating temperature range
- -40°C to 32°C functional detection temperature range
- At ambient temperatures greater than 32°C, light output will be switched to 50% brightness
- Rolling calibration sequence to filter out reflected light from the luminaire
- Pin out
  - 1 N/C
  - 2 DALI-/GND
  - 3 DALI+
  - 4 N/C

### MECHANICAL

- Height: 42.0mm
- Diameter: 79.7mm

### MATERIALS

- Dome: HDPE and polycarbonate
- Base: PBT

### ELECTRICAL

- 6-8mA average power consumption, 25mA on startup
- Powered from the DALI bus

### STANDARDS

- Zhaga book 18 editions 1, 2 and 3, (upcoming edition 4)
- DiiA: parts 351
- IEC 62386: part 303, 101 and 103
- CE and UKCA marked
- UL773
- IEC 61347-1
- IEC 61347-2-11
- Elexon charge code

### SPECIFICATIONS

- Application Specification: 114-160511
- Product Specification: [108-160457](#)

### PART NUMBER LIST

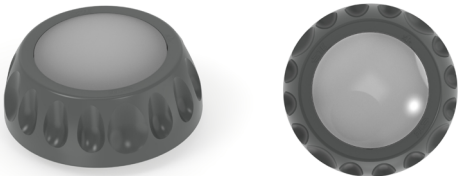
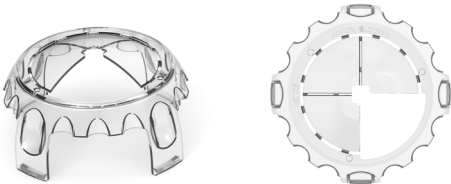
Product Images	Part Number	Description
	<p><a href="#">2444029-1</a></p> <p><a href="#">3-2444029-1</a></p>	<p>LUMAWISE Motion Sensor Programmable: Rectangular detection zone</p> <p>LUMAWISE Motion Sensor Programmable: Circular detection zone</p>
	<p><a href="#">2396399-1</a></p>	<p>LUMAWISE Motion Sensor Mask</p>

# LUMAWISE Motion Programmable

## Street lighting Motion Sensor

### LUMAWISE Motion Zhaga-D4i Certified

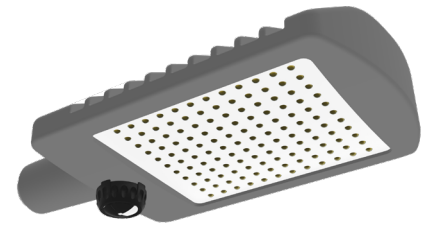
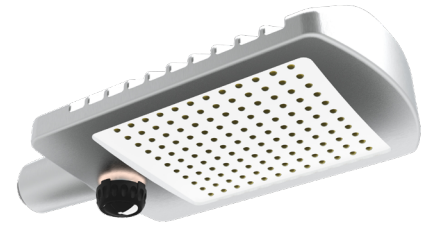
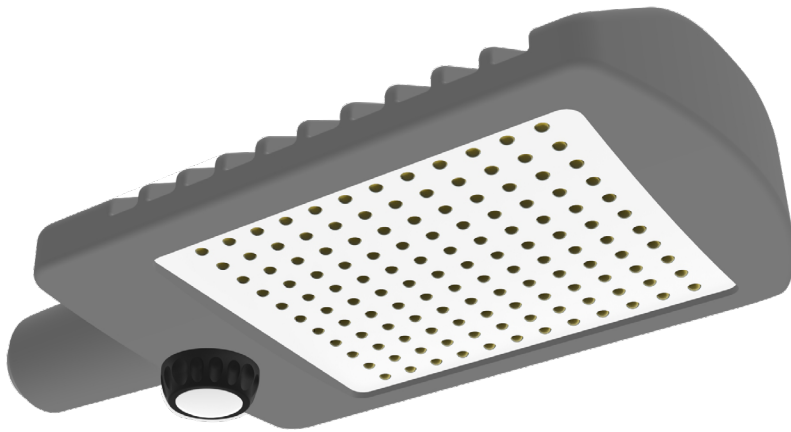

## ZHAGA TWO NODE ARCHITECTURE

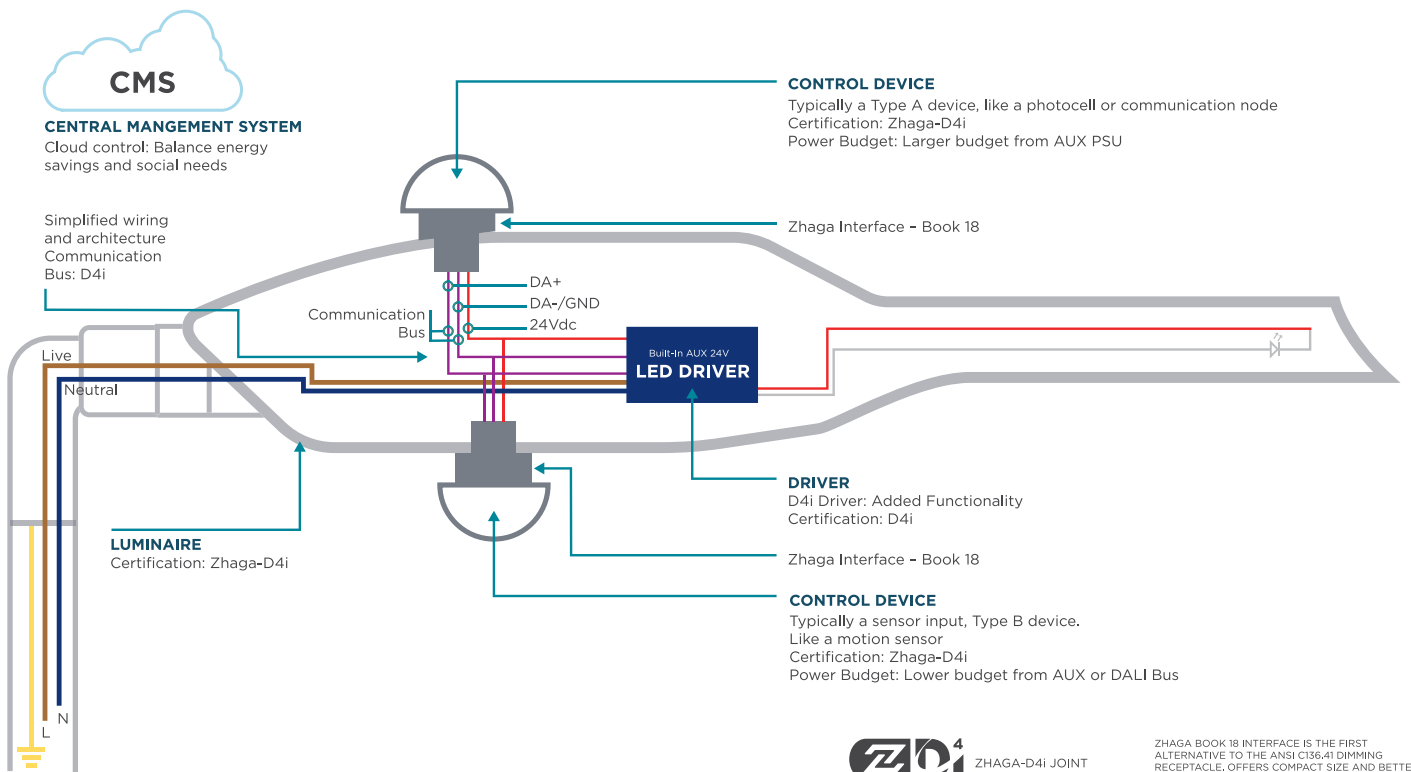

ZHAGA BOOK 18 INTERFACE IS THE FIRST ALTERNATIVE TO THE ANSI C136.41 DIMMING RECEPTACLE, OFFERS COMPACT SIZE AND BETTER INGRESS PROTECTION.

**Market Leading Detection Zone**

**TYPICAL DETECTION DIAGRAM AT 5M MOUNTING HEIGHT**

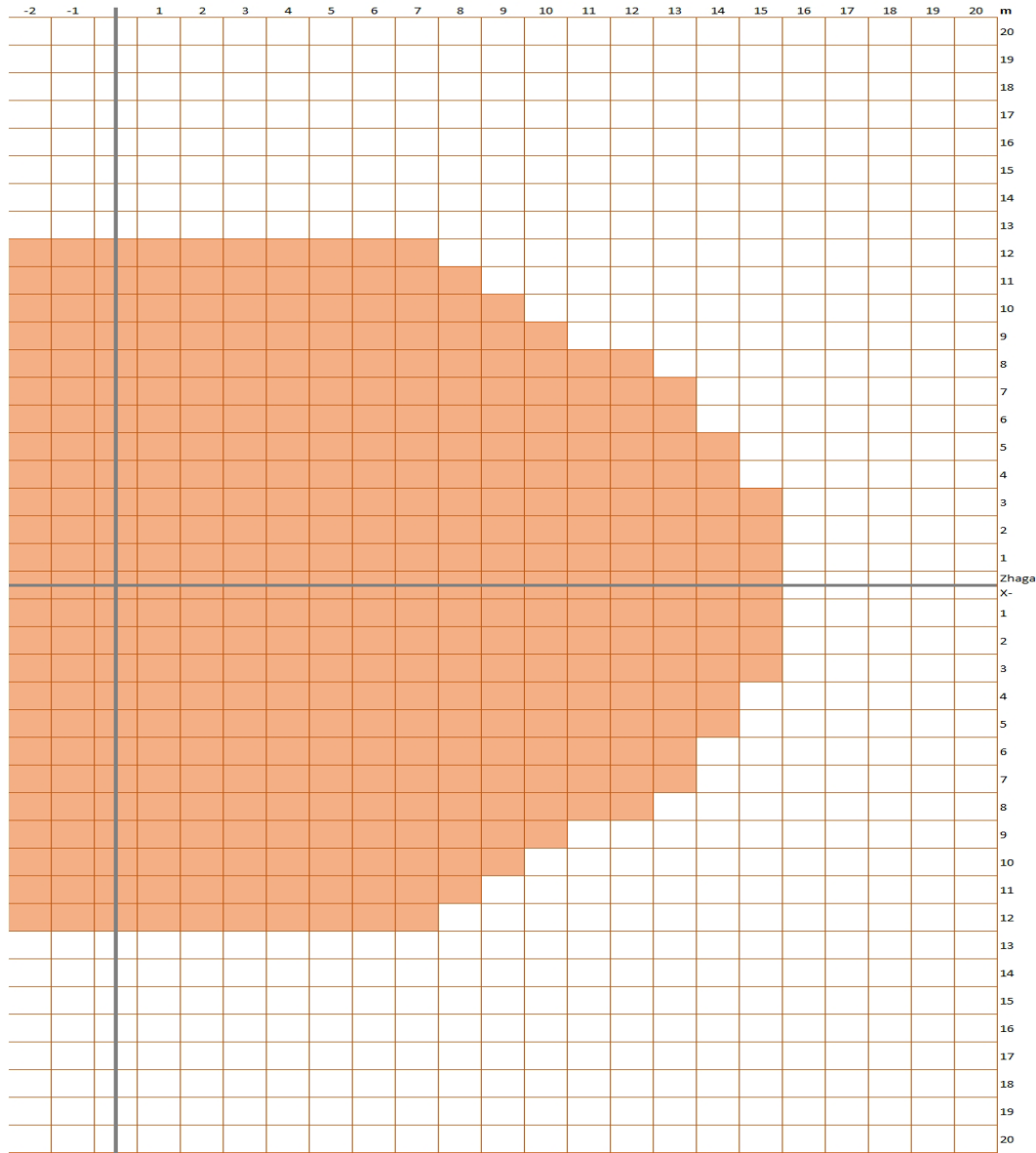

**Circular Detection Zone**  
Only one half of detection zone shown

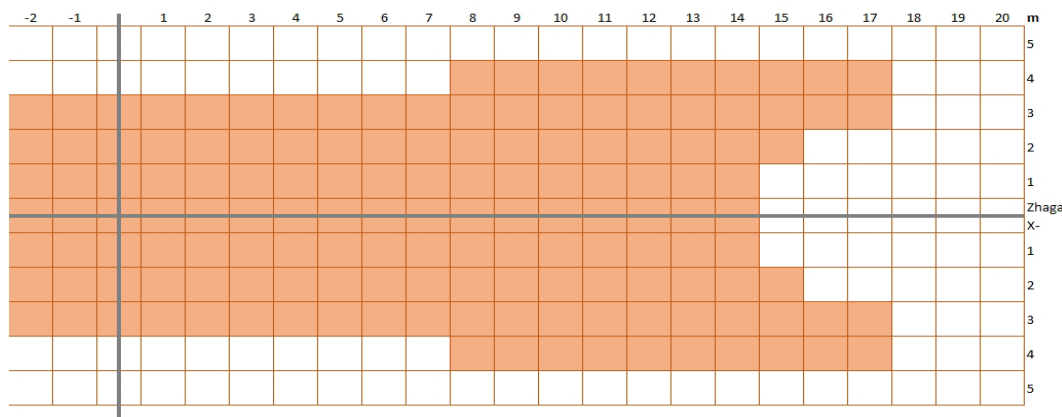

**Rectangular detection Zone**  
Only one half of detection zone shown

**Market Leading Detection Zone**

**TYPICAL DETECTION DIAGRAM AT 8M MOUNTING HEIGHT**

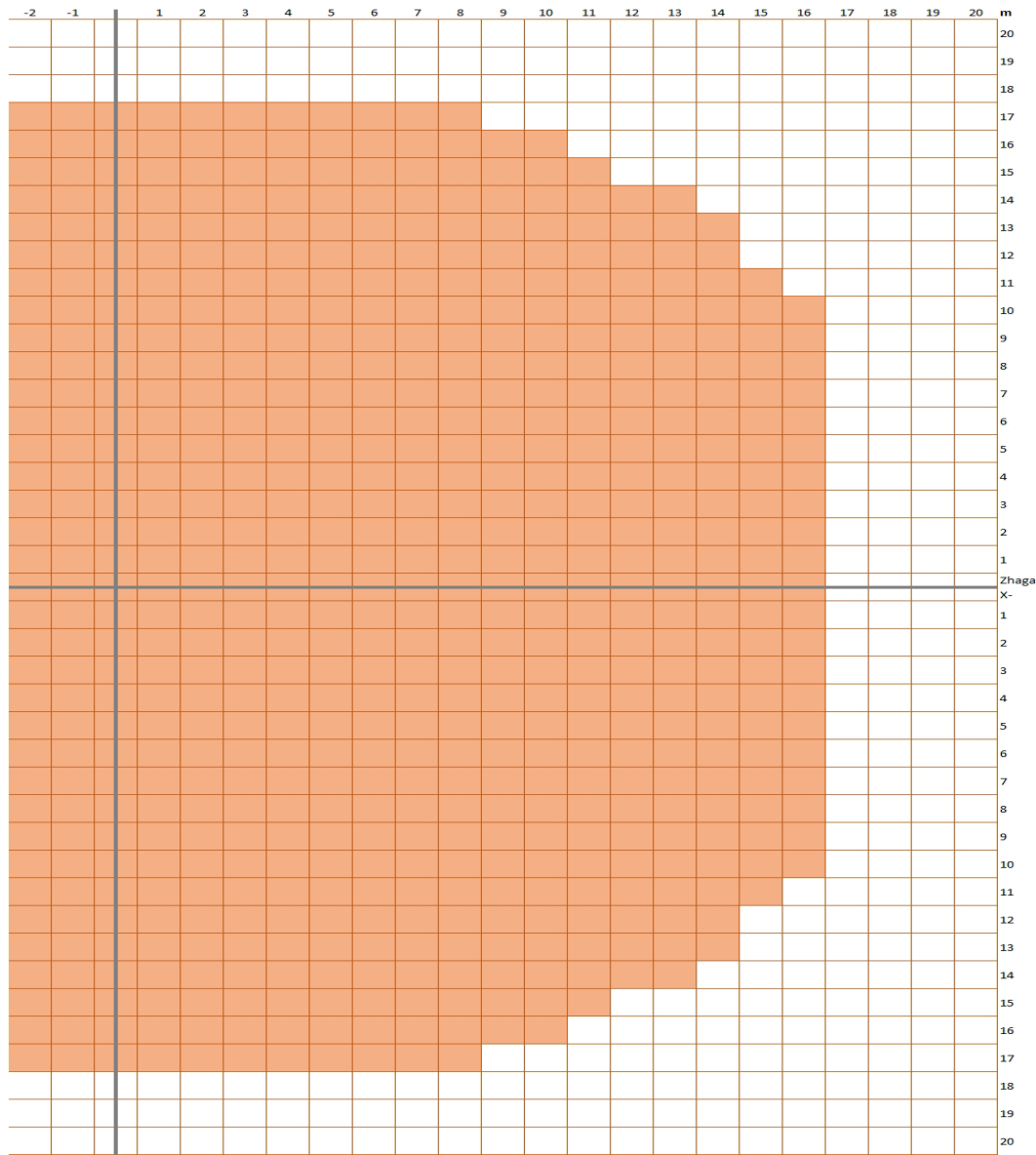

**Circular Detection Zone**

Only one half of detection zone shown

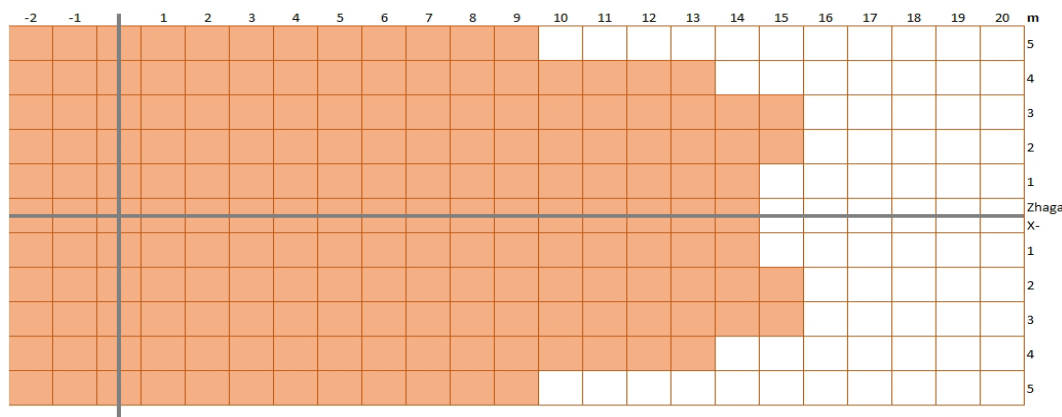

**Rectangular detection Zone**

Only one half of detection zone shown

**Market Leading Detection Zone**

**TYPICAL DETECTION DIAGRAM AT 12M MOUNTING HEIGHT**

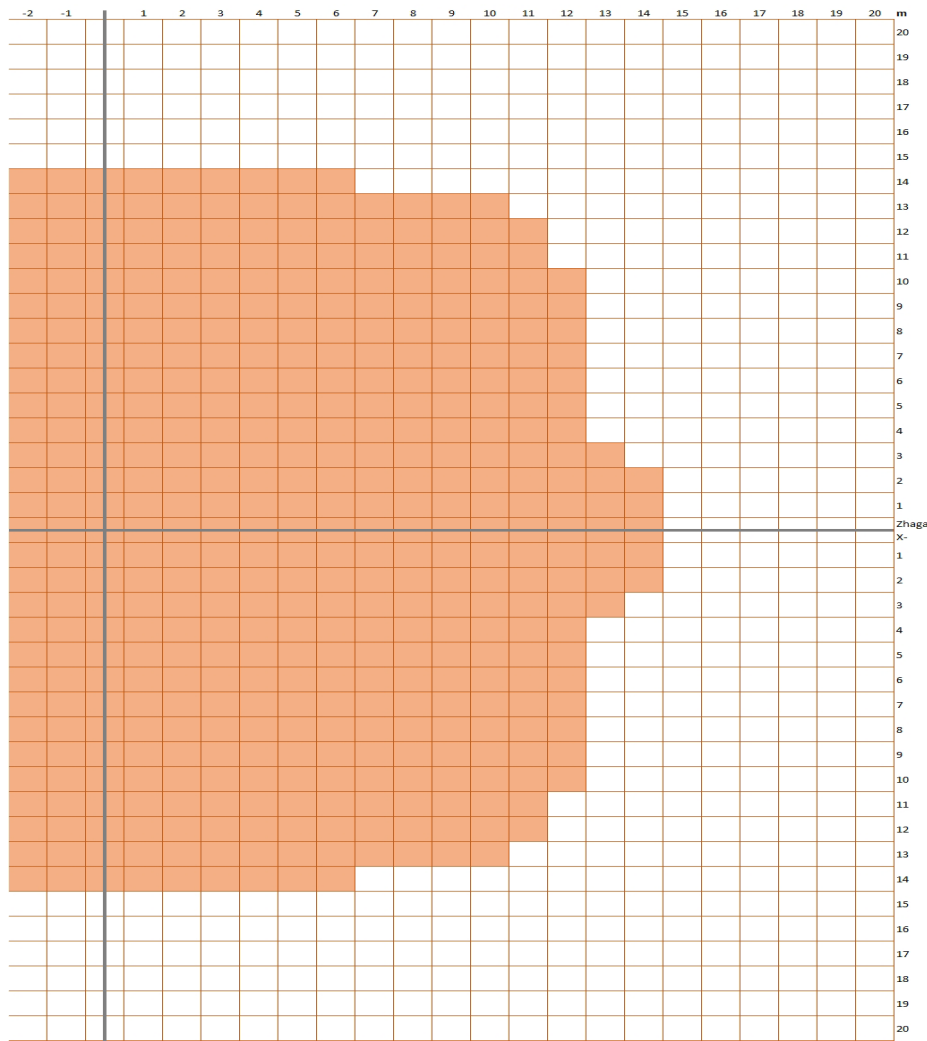

**Circular Detection Zone**  
Only one half of detection zone shown

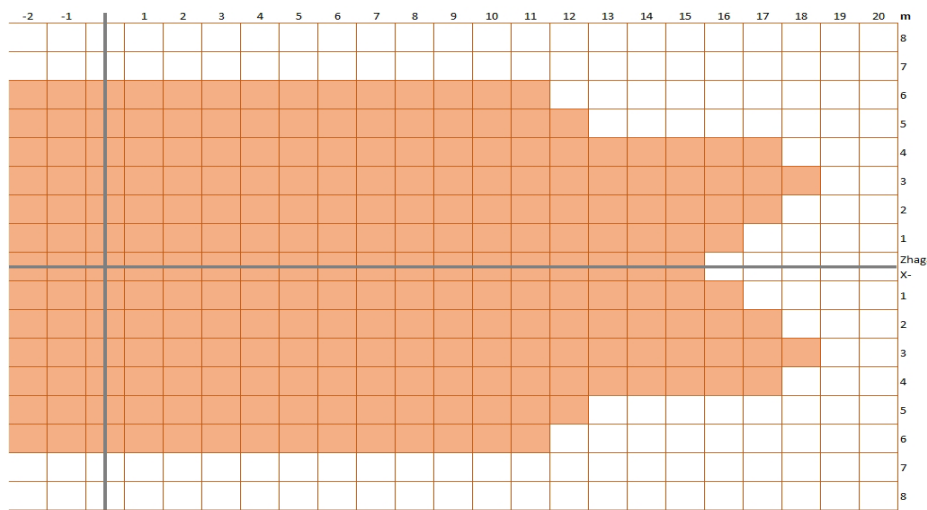

**Rectangular detection Zone**  
Only one half of detection zone shown

# LUMAWISE Motion Programmable

## Street lighting Motion Sensor

### Mechanical footprint

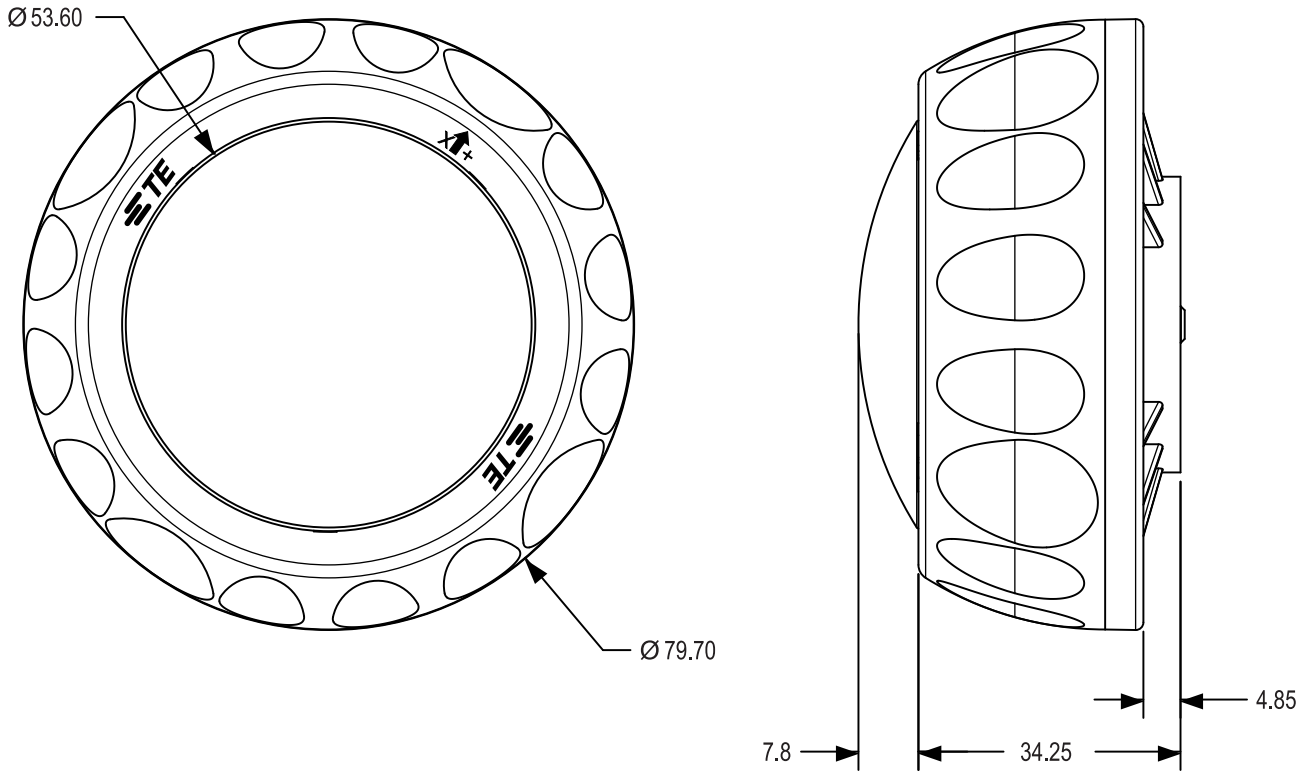

te.com

© 2023 TE Connectivity. All Rights Reserved.

LUMAWISE, TE Connectivity, TE connectivity (logo) and Every Connection Counts are trademarks owned or licensed by TE Connectivity. All other logos, products and/or company names referred to herein might be trademarks of their respective owners.

While TE has made every reasonable effort to ensure the accuracy of the information in this document, TE does not guarantee that it is error-free, nor does TE make any other representation, warranty or guarantee that the information is accurate, correct, reliable or current. TE reserves the right to make any changes to the information contained herein without prior notice. TE Connectivity assumes only those obligations set forth in the terms and conditions for this product and shall in no event be liable for any incidental, indirect, or consequential damages arising out of the sale, resale, use, or misapplication of the product. TE expressly disclaims any implied warranties with respect to the information contained herein, including, but not limited to, implied warranties of merchantability or fitness for a particular purpose. Dimensions, specifications and/or information contained herein are for reference purposes only and are subject to change without notice. Consult TE for the latest dimensions, specifications and/or information. Users of TE Connectivity products must make their own assessment as to whether the respective product is suitable for the respective desired application.

12/23 AK