

PRODUCT SPECIFICATION

AMP MINI MATCH CONNECTION SYSTEM

NUMBER 108-19.027

AMP SECURITY CLASSIFICATION

This information is confidential and is disclosed to you on condition that you will not disclose it to other than AMP personnel without written authorization from AMP-HOLLAND N.V.

1. SCOPE

This specification covers the general description and performance requirements of the AMP Mini Match Connection System which includes a complete product line of board-to-board and wire-to-board interconnections.

2. APPLICABLE DOCUMENTS

The latest revision of the following documents form a part of this specification to the extent indicated herein.

2.1. DIN Specifications :

- DIN 17660 Wrought copper alloys; copper-zinc alloys (brass); (special brass); chemical composition.
- DIN 17662 Wrought copper alloys; copper-tin alloys (tin bronze); chemical composition.
- DIN 17670 Plate, sheet and strip of wrought copper and copper alloys ; mechanical properties.

2.2. I.E.C. Specifications :

- I.E.C. 130 Connectors used for frequencies below 3MHz (Mc/s)
- I.E.C. 68 Basic environmental testing procedures for electronic components and electronic equipment.

2.3. Applicable Product Drawings.

				DR	DATE			AMP-HOLLAND N.V.	
				G. WILLESEN JUNE 17, 1982				HERTOGENBOSCH	
				CHK	DATE	LOC	NO	REV	C
				<i>[Signature]</i> JUNE 22, 1982					
				APP	DATE				
				SHEET 1 OF 11		NAME PRODUCT SPECIFICATION AMP-MINI MATCH CONNECTION SYSTEM			
LTR				REVISION RECORD					
				DR	CHK	DATE			

AMP 1386

RG-76

3. PRODUCT DESCRIPTION

3.1. Parts - The system consists of the following parts :

- 3.1.1. Male P.C.Board Connector Assembly, consisting of a housing and a number of spring contacts press-fit in the housing.
- 3.1.2. Right Angled Male (RAM) P.C. Board connector Assembly consisting of a housing and a number of spring contacts press-fit in the housing
- 3.1.3. Female Board-to-Board (F.B.T.B.) Connector Assembly consisting of a housing and a number of receptacles press-fit in the housing
- 3.1.4. Vertical Female on Wire (V.F.O.W.) Connector Assembly consisting of a housing and a number of receptacles with slotted beam section press-fit in the housing and suitable for insulation displacement technique.  
Acceptable wires are : 0,4-0,5 mm dia. solid  
0,2-0,22 mm<sup>2</sup> stranded (7 x 0,2 mm dia)  
0,8 - 1,4 mm dia. insulation  
shore "A" hardness >90

3.2. Type - The chosen center line distance of the Mini Match connection system is 2,5 mm (.0984") or 5mm (.197") or one multiple of this in case of random loaded connectors which are available for all versions.

3.3. Design and Construction :

- 3.3.1. General - Connector Assemblies shall be of the design, construction and physical dimensions as specified on the applicable product drawings.
- 3.3.2. Material and Finish.
  - A. Housings : The male, F.B.T.B. and V.F.O.W. housings are moulded of PBT with 20% glass, flammability rating UL 94 VO. The RAM housing is moulded of PC with 20%glass, flammability rating UL 94 VO
  - B. Receptacles : Receptacles shall be fabricated of brass or phosphorbronze confirming DIN specifications. They shall be tinplated with nickel underlayer.

3.4. Application :

By this system, connections between Printed Circuit Boards and between wire and Printed Circuit Boards, can be made in perpendicular and inline position. For hole pattern in PC Board see Fig.1 on page 9.

This information is confidential and is disclosed to you on condition that no further disclosure is made by you to other than AMP personnel without written authorization from AMP-HOLLAND N.V.

AMP SECURITY CLASSIFICATION

NUMBER 108-19.027

SHEET				AMP-HOLLAND N.V.	
2 OF 11		LOC H A		HERTOGENBOSCH HOLLAND	
		NO		108-19.027	
		REV		C	
NAME PRODUCT SPECIFICATION AMP-MINI MATCH CONNECTION SYSTEM					

3.4.1. Typical Application :

See Fig. 2 on page 10.

4. PERFORMANCE AND TEST DESCRIPTION

4.1. Temperature rating :

Each assembly shall be capable of continuous operation throughout an ambient temperature range of -40°C to +85°C.

4.2. Current rating :

The maximum permissible current shall be as specified in Fig. 3 on page 11.

4.3. Voltage rating :

The rated voltage shall be 354 Volts D.C. or A.C. peak as specified in I.E.C. 130-1 clause 5.

4.4. Test conditions :

Unless specifically stated, tests and examinations required by this specification shall be executed under any combination of conditions as specified in I.E.C. 68-1 clause 5.3.

4.5. Test samples :

All samples must be selected at random from current production and be checked according to the Quality Inspection Plan (Q.I.P.) of Mini Match assemblies.

4.5.1. Test group I + II. The samples contained in these groups shall consist of the male, right angled male and female board to board assemblies, all soldered on P.C.Boards in a way that series circuits can be created. The vertical female on wire assembly is applied to appropriate wire by means of a suitable tool.

4.5.2. Test group III. The samples contained in this group shall consist of the male, right angled male and female board to board assemblies which are not soldered to P.C.Boards.

4.5.3. Test group IV. The samples contained in this group shall consist of vertical female on wire assemblies supplied with appropriate wires by means of a suitable tool.

NUMBER  
108.19027

AMP SECURITY  
CLASSIFICATION

This information is confidential and is disclosed to you on condition of confidentiality and is made by you to other than AMP personnel without written authorization from AMP-HOLLAND N.V.

SHEET				AMP-HOLLAND N.V. HERTOGENBOSCH HOLLAND	
3	OF 11	LOC H	A	NO 108-19.027	REV C
NAME PRODUCT SPECIFICATION AMP-MINI MATCH CONNECTION SYSTEM					

NUMBER  
108-19.027

AMP SECURITY  
CLASSIFICATION

This information is confidential and is disclosed to you on condition that no further disclosure is made by you to other than AMP personnel without written authorization from AMP-HOLLAND N.V.

5. QUALITY ASSURANCE PROVISIONS

5.1. Qualification Inspection :

5.1.1. Sample selection.

Connector assemblies and contacts shall be prepared in accordance with applicable Product- and Customer-drawings.

Number of testsamples in accordance with I.E.C. 130-1 clause 9.

5.1.2. Test sequence.

Qualification Inspection shall be verified by testing the samples to the test sequence as specified under 6.2.

5.1.3. Acceptance.

When testing the samples as specified, all results will fall within the specification limits 99% of the time with a confidence level of 95%. Failures attributed to equipment, test set-up or operator deficiencies will not disqualify the product.

When product failure occurs, corrective action will be taken and samples shall be re-submitted for qualification.

5.1.4. Test report.

A report containing test data-analysis and product performance evaluation shall be issued at the completion of the qualification test program.

5.2. Quality Conformance Inspection :

Sampling procedures shall be in accordance with MIL-STD-105. The applicable AMP Quality Inspection Plan will specify the Sampling and Acceptance Quality Level to be used.

Dimensional and functional requirements will be in accordance with the applicable Product drawings.

SHEET				AMP-HOLLAND N.V. T-HERTOGENBOSCH HOLLAND	
4 OF 11	LOC H	A	NO 108-19.027	REV C	
NAME PRODUCT SPECIFICATION AMP MINI MATCH CONNECTION SYSTEM					

This information is confidential and is disclosed to you on condition that no further disclosure is made by you to other than AMP personnel without written authorization from AMP-HOLLAND N.V.

AMP SECURITY  
CLASSIFICATION

NUMBER

108-19.027

6. TEST SCHEDULE FOR TYPE TESTS

- 6.1. The testschedule, table 1 and 2 on page 6 and 7, shows all tests, conditions of tests as well as the requirements to be met for each type of connector.
- 6.2. The testsequence, tabel 3 page 8, shows the order in which the tests shall be carried out.

SHEET			AMP-HOLLAND N.V.	
			's-HERTOGENBOSCH HOLLAND	
5 OF 11	LOC H	A	NO 108-19.027	REV C
NAME PRODUCT SPECIFICATION AMP MINI MATCH CONNECTION SYSTEM				

TABLE 1.

NUMBER 108-19.027  
 AMP SECURITY CLASSIFICATION

Test Description	Clause of IEC 130-1	Conditions of test	Requirements
Examination of Prod.	11-12		Meets requirements of product drawings
Contact Resistance	14.1 14.1.3	25% of all contacts, with a min. of 2- of each sample shall be measured. The E.M.F. of the measuring circuit shall not exceed 20mV. I=100mA max. Measuring points see Fig.2 page 10	10 milliohm max.
Insulation resistance	14.4	100 ± 15 V	1000 Megohm min.
Voltage Proof	14.5	1 minute 1000 V/50 Hz	No breakdown or flashover
Damp Heat accelerated	18.2.2	I.E.C. 68-2-4 Test D 24 hours cycle with 80-100% RH. Not under mechanical and electrical load.	Termination resistance 10 milliohm max.
Cold	18.2.3	I.E.C.68-2-1 Test Aa -40°C for 2 hours. Not under mechanical and electrical load.	Termination resistance 10 milliohm max.
Damp heat long term.	18.3	I.E.C.68-2-3 Test Ca +40°C, 93% RH for 21days half lot mated, half lot unmated. Not under mech. and electrical load.	Termination resistance 10 milliohm max.
Dry Heat	18.2.1	I.E.C.68-2-2 Test Ba +85°C for 16 hours Not under mechanical and electrical load.	
Rapid Change of Temperature	18.4	I.E.C.68-2-14 Test Na -40°C/+85°C, 6 cycles ½ hour/½ hour. Not under mechanical and electrical load	

This information is confidential and is disclosed to you on condition that no further disclosure is made by you to other than AMP personnel without written authorization from AMP-HOLLAND N.V.

SHEET		 AMP-HOLLAND N.V. 'HERTOGENBOSCH HOLLAND		REV
6 OF 11	LOC			NO
	H	A	108-19.027	
NAME PRODUCT SPECIFICATION AMP MINI MATCH CONNECTION SYSTEM				

TABLE 2.

TEST DESCRIPTION	CLAUSE OF IEC 130-1	CONDITIONS OF TEST	REQUIREMENTS
Salt Mist	18.7	I.E.C.68-2-11 Test Ka 35°C for 24 hours half lot mated half lot unmated	
Insertion/Extraction Force	16.1	Measuring force to insert and extract male contacts in female connector assemblies	5 N max./contact 1 N min./contact
Mechanical Endurance	19	Number of operations: 25 Frequency of operations 10/minute. Minimum time between successive operations 1 second	
Vibration	16.4	I.E.C. 68-2-6 Test Fc Procedure B4 10-55 Hz sweeping for 6 hours	No discontinuity above 1 micro-second; no physical damage; contact resistance 10 millichm max.
Contact retention of Male R.A.H. F.B.T.B. V.F.O.W.		Apply an axial load of: 10 N to male contacts 10 N to R.A.H. contacts 5 N to F.B.T.B. contacts 10 N to V.F.O.W. contacts	Contacts will not dislodge from housings
Axial tensile strength of wire termination		Apply an axial load with an application rate of 25 mm/min.	10 N min.
Solderability		I.E.C. 68-2-10 Test T Rev. C solderbath 235°C	Max. 5% dewetting of functional area
Resistance to Soldering heat	15.3	I.E.C. 68-2-20 Test Tb Method 1A; solderbath 260°C 5 sec. max.	No functional damaging

This information is confidential and is disclosed to you on condition that no further disclosure is made by you to other than AMP personnel without written authorization from AMP-HOLLAND N.V.

AMP SECURITY CLASSIFICATION

NUMBER

108-19.027

SHEET				AMP-HOLLAND N.V. 1-HERTOGENBOSCH HOLLAND	
7 OF 11		LOC H	A	NO 108-19.027	REV C
NAME PRODUCT SPECIFICATION AMP- MINI MATCH CONNECTION SYSTEM					

TABLE 3

NUMBER 108-19.027

AMP SECURITY CLASSIFICATION

This information is confidential and is disclosed to you on condition that no further disclosure is made by you to other than AMP personnel without written authorization from AMP-HOLLAND N.V.

TEST OR EXAMINATION	Group I				Group II				III	IV	
	LOT:	1	2	3	4	1	2	3	4	1	1
Examination of Product	X	X	X	X	X	X	X	X	X	X	X
Termination Resistance	X	X	X	X							
Insulation Resistance					X	X	X				
Voltage Proof					X	X	X				
Insertion/Extraction Force	X	X									
Contact Retention					X						
Tensile Strength (half lot)											X
Damp Heat Long Term			X				X				
Change of Temperature				X							X
Dry Heat	X				X						
Tensile Strength (half lot)											X
Damp Heat Accelerated 2 cycl.								X	X		
Mechanical Endurance		X									
Insertion/Extraction Force		X									
Damp Heat Accelerated 1 cycl.	X				X						
Termination Resistance	X	X	X	X							
Insulation Resistance				X	X						
Voltage Proof				X	X						
Salt Mist		X				X					
Cold	X				X						
Damp Heat Accelerated 5 cycl.	X				X						
Termination Resistance	X	X									
Mechanical Endurance		X									
Insertion/Extraction Force	X	X									
Vibration				X							
Termination Resistance		X		X							
Insulation Resistance					X	X	X				
Voltage Proof					X	X	X				
Contact Retention					X						
Solderability								X	X		
Resistance to Soldering Heat								X			
Examination of Product	X	X	X	X	X	X	X	X	X	X	X

SHEET				AMP-HOLLAND N.V. HERTOGENBOSCH HOLLAND	
<u>8</u> OF <u>11</u>	LOC H	A	NO	108-19.027	REV C
NAME PRODUCT SPECIFICATION AMP MINI MATCH CONNECTION SYSTEM					



This information is confidential and is disclosed to you on condition that no further disclosure is made by you to other than AMP personnel without written authorization from AMP-HOLLAND N.V.

AMP SECURITY CLASSIFICATION

NUMBER

108-19.027

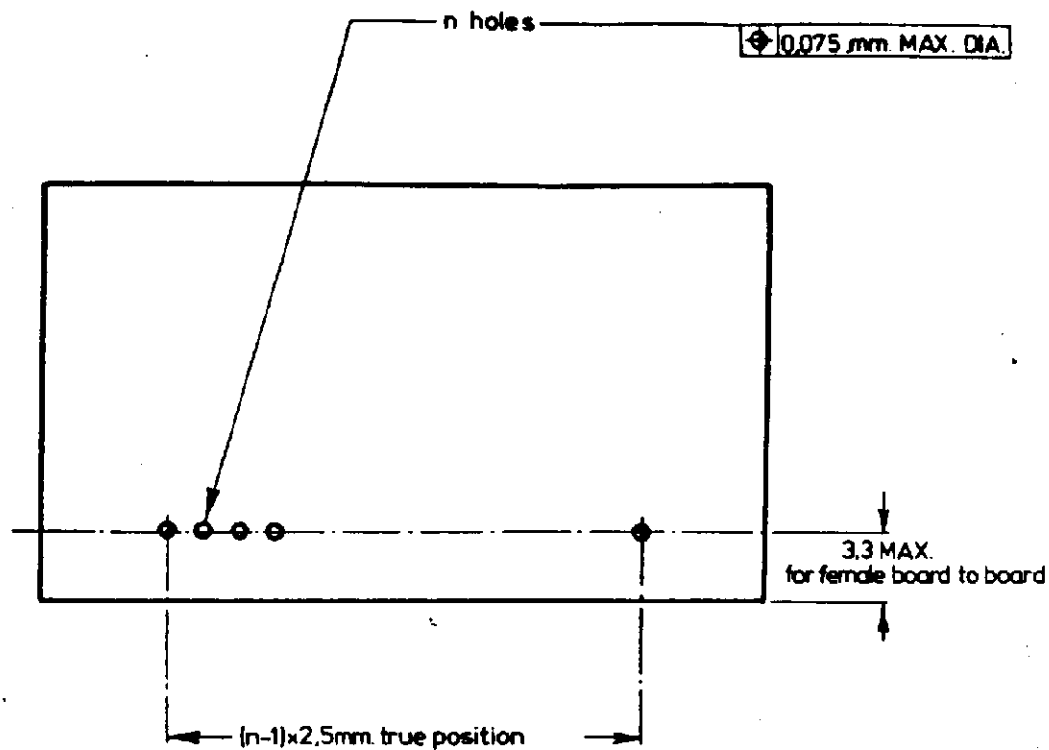

Recommended diameter  
for unplated holes only

$1.0 \begin{matrix} + 0 \\ - 0.1 \end{matrix}$  mm for  $n \leq 10$

$1.0 \begin{matrix} + 0.1 \\ - 0 \end{matrix}$  mm for  $n > 10$

Fig. 1 Hole pattern in P.C.B. for Mini Match Board Connectors

SHEET				AMP-HOLLAND N.V. 1-HERTOGENBOSCH HOLLAND	
9 OF 11		LOC	A	NO	REV
		H		108-19.027	C
NAME PRODUCT SPECIFICATION AMP MINI MATCH CONNECTION SYSTEM					

This information is confidential and is disclosed to you on condition that no further disclosure is made by you to other than AMP personnel without written authorization from AMP-HOLLAND N.V.

AMP SECURITY CLASSIFICATION

NUMBER

108-19.027

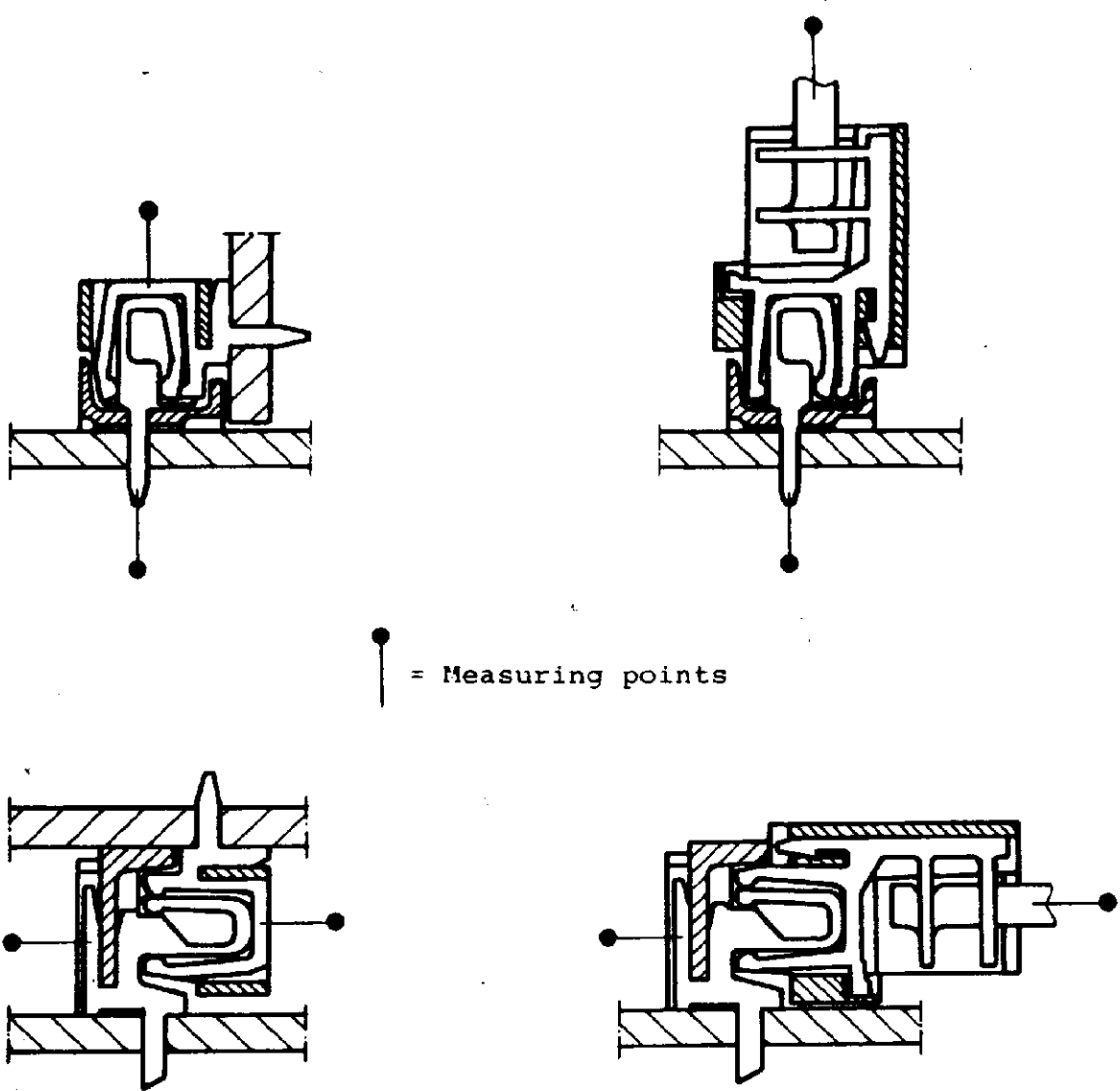
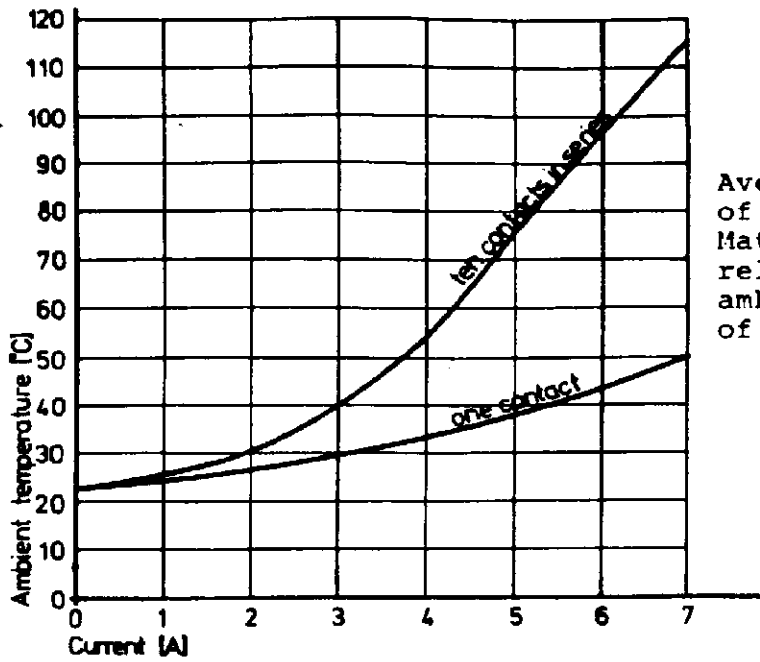

Fig. 2 Typical applications and measuring points

SHEET				AMP-HOLLAND N.V. HERTOGENBOSCH HOLLAND	
10 OF 11	LOC H	A	NO	108-19.027	REV C
NAME PRODUCT SPECIFICATION AMP MINI MATCH CONNECTION SYSTEM					

This information is confidential and is disclosed to you on condition of your agreement to maintain its confidentiality. No further disclosure is made by you to other than AMP personnel without written authorization from AMP-HOLLAND N.V.



Average temperature of a 10 pos. Mini-Match connection related to the ambient temperature of 23°C.

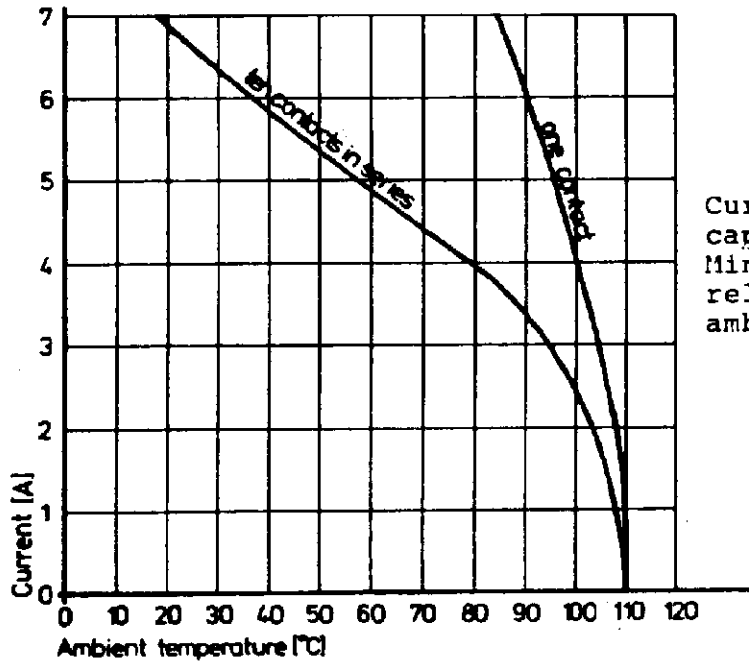

Current carrying capacity of a 10 pos. Mini-Match connection related to the ambient temperature.

Fig. 3 Current rate curves

SHEET		<b>AMP</b>		AMP-HOLLAND N.V. 1-HERTOGENBOSCH HOLLAND	
11	OF 11	LOC	A	NO	108-19.027
NAME		REV			
PRODUCT SPECIFICATION AMP		C			
MINI MATCH CONNECTION SYSTEM					