

# Product Specification

108-60027

## AMP Mini CT Hybrid Drawer Connector, 1.5mm Pitch Lead Free Version

- 1. Scope:
- 1.1 Contents:

This specification covers the requirements for product performance, test methods and quality assurance provisions of AMP Mini CT Hybrid Drawer Connector, 1.5mm Pitch, Lead Free Version. Applicable product description and part numbers are as shown in Fig.1.

Product Part No.	Description
x-292239-x	Plug Assembly, 1.5mm Pitch Mini CT Hybrid Drawer Connector, Lead Free
x-292240-x	Receptacle Assembly, 1.5mm Pitch Mini CT Hybrid Drawer Connector Lead Free
x-292241-x	Plug Assemble, 1.5mm Pitch Mini CT SF Hybrid Drawer Connector, Lead Free
x-292242-x	Receptacle Assembly, 1.5mm Pitch Mini CT SF Hybrid Drawer Connector, Lead Free
x-179316-x	Receptacle Crimp Contact (#16-20) for Drawer Connector
x-179317-x	Receptacle Crimp Contact (#20-24) for Drawer Connector
x-316458-x	Receptacle GND Contact (#16-20) for Drawer Connector
x-179321-x	Plug Crimp Contact (#16-20) for Drawer Connector
x-179322-x	Plug Crimp Contact (#20-24) for Drawer Connector

Fig. 1

2. Applicable Documents

The following documents form a part of this specification to the extent specified herein. In the event of conflict between the requirements this specification and the product drawing, the product drawing shall take precedence. In the event of conflict between the requirements this specification and referenced documents, this specification shall take precedence.

THIS INFORMATION IS CONFIDENTIAL AND IS DISCLOSED TO YOU ON CONDITION THAT NO FURTHER DISCLOSURE IS MADE BY YOU TO OTHER THAN AMP PERSONNEL WITHOUT WRITTEN AUTHORIZATION FROM AMP SHANGHAI LTD

O	RELEASED FB00-0040-03	J.J	04APR 03	DR	J. JIANG	<b>tyco</b> <i>Electronics</i>	Tyco Electronics AMP Shanghai Ltd				
				CHK	S. YAO						
				APP	T. SASAKI	NO	108-60027	REV	O	LOC	FB
				PAGE 1 of 9		TITLE AMP Mini CT Hybrid Drawer Connector, 1.5mm Pitch, Lead Free Version					
LTR	REVISION RECORD	DR	DATE								

2.1 AMP Specifications:

A. 109-5000 Test Specification, General Requirements for Test Methods

B. 114-5182 Application Specification

C. 501-51021 Qualification Test Report

2.2 Commercial Standards and Specifications:

A. MIL-STD-202: Test Methods for Electronic and Electrical Component Parts.

B. IEC: International Electrotechnical Commission

3. Requirements:

3.1 Design and Construction:

Product shall be of the design, construction and physical dimensions specified on the applicable product drawing.

3.2 Materials:

3.2.1 Plug Assembly

A. Signal Contact

Material: Phosphor Bronze

Finish (Mini CT post area): Tin plating over Nickel underplating

Finish (Drawer mating area): i) Gold plating over Nickel underplating, or  
ii) Gold over Palladium-Nickel over Nickel underplating

B. Power Contact

Material: Brass

Finish (Gold Version) Gold (mating area), Tin (crimp area) over Nickel underplating

Finish (Tin Version) Pre-plated Tin

C. Housing

Material: Glass-filled PBT UL94V-0

### 3.2.2 Receptacle Assembly

#### A. Signal Contact

Material: Brass  
Finish (Mini CT post area): Tin plating over Nickel underplating  
Finish (Drawer mating area): i) Gold plating over Nickel underplating  
ii) Gold over Palladium-Nickel over Nickel underplating

#### B. Power Contact

Material: Phosphor Bronze  
Finish (Gold Version): Gold (mating area), Tin (crimp area) over Nickel underplating  
Finish (Tin Version): Pre-plated Tin

#### C. Housing

Material: Glass-filled PBT UL94V-0

### 3.3 Ratings:

A. Voltage Rating (Signal): 50 V(AC/DC)

Voltage Rating (Power): 250 VAC

B. Current Rating (Signal): 1A Max

Current Rating (Power): AWG #16 (1.25 mm<sup>2</sup>): 12 A

AWG #18 (0.85 mm<sup>2</sup>): 10 A

AWG #20 (0.5 mm<sup>2</sup>): 7 A

AWG #22 (0.3 mm<sup>2</sup>): 5 A

AWG #24 (0.2 mm<sup>2</sup>): 4 A

C. Temperature Rating: -30°C to +105°C

The upper limit of the temperature includes the temperature rising resulted by the energized electrical current.

### 3.4 Performance Requirements and Test Descriptions:

The product shall be designed to meet the electrical, mechanical and environmental performance requirements specified in Fig.2. All tests shall be performed in the room temperature unless otherwise specified.

3.5 Test Requirements and Procedures Summary:

Para.	Test Items	Requirements	Procedures			
3.5.1	Examination of product	Product shall be confirming to the requirements of applicable product drawing and applicable Specification	Visually, dimensionally and functionally inspected per applicable quality inspection plan			
<b>Electrical Requirements</b>						
3.5.2	Termination Resistance (Low Level)	Signal Line: 30 mΩ Max. (Initial) 40 mΩ Max. (Final) Power Line: 6 mΩ Max. (Initial) 10 mΩ Max. (Final)	Subject mated connectors to 20 mV Max open circuit at 10 mA Refer Fig. 4			
3.5.3	Dielectric withstanding voltage	No creeping discharge or flashover shall occur. Current leakage: Signal Line 5mA Max. Power Line 1mA Max.	Signal Line: 500 VAC for 1 minute. Power Line: 1.8 kVAC for 1 minute. Test between adjacent circuits of mated connectors. MIL STD 202 TEST Method 301 IEC 512-2 TEST 4A			
3.5.4	Insulation Resistance	500 MΩ Min. (Initial) 100 MΩ Min. (Final)	Impressed voltage 500VDC for 1 minute. Test between adjacent circuits of mated connectors. MIL STD 202 TEST Method 302 Condition B			
3.5.5	Temperature Rising vs. Current	30°C Max. under loaded rating current	Contacts series-wired, apply test current of loaded rating current to the circuit, and measure the temperature rising by probing on soldered areas of contacts, after the temperature becomes stabilized deduct ambient temperature from the measured value			
<b>Mechanical Requirements</b>						
3.5.6	Crimp Tensile Strength (Power contacts only)	Wire Size		Crimp Tensile (Min.)	Apply an axial pull-off load to a crimp wire, with the contact secured to the tester. Operation Speed: 100 mm/min.	
		mm <sup>2</sup>	AWG			N
		0.2	#24	19.6		2.0
		0.3	#22	34.3		3.5
		0.5	#20	45.1		4.6
		0.85	#18	98.0		10.0
1.25	#16	186.2	19.0			
3.5.7	Contact-housing Insertion Force (Power contacts only)	14.7 N (1.5 kgf) Max. per contact		Measure force required to insert contact into housing.		

Fig.2. To be continued

	<b>Tyco Electronics</b> <b>AMP Shanghai Ltd</b>	PAGE	NO	REV	LOC
		<b>4</b>	108-60027	O	FB

Para.	Test items	Requirements			Procedures
3.5.8	Contact Retention Force	Signal Contact: Receptacle: 14.7N (1.5kgf) Min. Tab: 7.84 N(0.8kgf) Min. Power Contact: 58.9 N (6.0 kgf) Min.			Measure contact retention force. Operation Speed: 100 mm/min.
3.5.9	Connector Mating Force	Pos. size (Power /Signal)	Initial	After Durability	Operation Speed: 100 mm/min. Measure the force required to mated connectors
		4/12	40.2N (4.1 kgf) Max.	60.8N (6.2 kgf) Max.	
3.5.10	Connector Unmating Force	Pos. size (Power/Signal)	Initial & After Durability Min.		Operation Speed: 100 mm/min. Measure the force required to unmate connectors.
		4/12	6.5 N (0.66 kgf)		
3.5.11	Panel Retention Force (For Snap-Fit only)	98N (10 kgf) Min.			Measure panel retention force using panel of nominal cut-out dimension as specified in the AMP Customer Drawing. Loading is made from the direction opposite to connector insertion direction.
3.5.12	Durability (Repeated Mate/Unmating)	Signal Line: 40 mΩ Max. (Final) Power Line: 10 mΩ Max. (Final)			Operation Speed: 100mm/min. No. of Cycles: Gold Version: 3000 cycles Pre-tin Version: 30 cycles
3.5.13	Vibration (Low Frequency)	No electrical discontinuity greater than 1 μ sec. Shall occur. Signal Line 40 mΩ Max. (Final) Power Line: 10 mΩ Max. (Final)			Subject mated connectors to 10-55-10 Hz traversed in 1 minute at 1.52mm amplitude 2 hours each of 3 mutually perpendicular planes. MIL-STD-202 TEST Method 201 Condition A Mounting: Fig. 5

Fig. 2 (To be continued)

	Tyco Electronics AMP Shanghai Ltd	PAGE 5	NO 108-60027	REV O	LOC FB
---	--------------------------------------	-----------	-----------------	----------	-----------

Para.	Test Items	Requirements	Procedures
3.5.14	Physical Shock	No electrical discontinuity greater than 1 $\mu$ sec. Shall occur. Signal Line: 40 m $\Omega$ Max. (Final) Power Line: 10 m $\Omega$ Max. (Final)	Accelerated Velocity: 490 mm/s <sup>2</sup> (50G) Waveform: halfsine shock pulse Duration: 11 m sec Number of shocks: 3 shocks in each direction applied along the X, Y and Z axes, totally 18 shocks. MIL-STD-202 TEST Method 213 Condition A IEC 68-2-27, Test Ea Mounting: Fig. 5
3.5.15	Hammering Shocks	No electrical discontinuity greater than 1 $\mu$ sec. Shall occur. Signal Line: 40 m $\Omega$ Max. (Final) Power Line: 10 m $\Omega$ Max. (Final)	Subject mated connectors to 10,000 cycles of hammering shocks in set up as shown in Fig. 6, with test current of 1 mA at DC 10V applied to circuits as shown in Fig. 7 During the test, the circuit shall be monitored for fluctuation of electrical resistance.
<b>Environmental Requirements</b>			
3.5.16	Thermal Shock	Signal Line: 40 m $\Omega$ Max. (Final) Power Line: 10 m $\Omega$ Max. (Final)	Subject mated connectors to -55 °C/30min., +85 °C/30min. This being 1 cycle repeat for a total of 25 cycles. MIL-STD-202 TEST Method 107
3.5.17	Humidity-Temperature Cycling	Insulation resistance 100 M $\Omega$ Min. (Final) Termination resistance Signal Line: 40 m $\Omega$ Max. (Final) Power Line: 10 m $\Omega$ Max. (Final)	Subject mated connector to 25-65°C, 90-95 %R.H., 10 cycles. With cold shock -10 °C. Re-condition in room temperature for 3hrs before subsequent measurement. MIL-STD-202 TEST Method 106 IEC 68-2-38, Test Z/AD.
3.5.18	Salt Spray	Signal Line: 40 m $\Omega$ Max. (Final) Power Line: 10 m $\Omega$ Max. (Final)	Subject mated connectors to 5 $\pm$ 1% salt concentration for 48 hours. After test, rinse the samples with water and recondition the room temperature for 1 hour before subsequent measurements MIL-STD-202 TEST Method 101, Condition B. IEC 68-2-11, Test Ka.
3.5.19	Temperature Life (Heat Aging)	Signal Line: 40 m $\Omega$ Max. (Final) Power Line: 10 m $\Omega$ Max. (Final)	Subject mated connector to 85 $\pm$ 2°C, 500 hours. MIL-STD-202 TEST Method 108.

Fig. 2 (End)

<b>tyco</b> Electronics	<b>Tyco Electronics AMP Shanghai Ltd</b>	PAGE <b>6</b>	NO 108-60027	REV O	LOC FB
----------------------------	--	------------------	-----------------	----------	-----------

4. Product Qualification Test Sequence

Test of Examination	Test Group															
	1	2	3	4	5	6	7	8	9	10	11	12	13	14	15	
	Test Sequence(a)															
Examination of Product	1,4,8	1,3	1,3	1,3	1,3	1,3	1,3	1,3	1,3	1,5	1,5	1,5	1,5	1,5	1,5	1,5
Termination Resistance (Low Level)	2, 5									2,4	2,4	2,4	2,4	2,4	2,4	2,4
Dielectric withstanding voltage	7															
Insulation Resistance	6															
Temperature Rising vs. Current		2														
Crimp Tensile Strength			2													
Contact-housing Insertion Force				2												
Contact Retention Force					2											
Connector Mating Force						2										
Connector Unmating Force							2									
Panel Retention Force								2								
Durability Cycling									3							
Vibration (Low Frequency)										3						
Physical Shock											3					
Hammering Shocks												3				
Thermal Shock													3			
Humidity-Temperature Cycling	3															
Salt Spray															3	
Temperature Life (Heat Aging)																3

(a) Numbers indicated sequence in which tests are performed.

Fig.3

	<b>Tyco Electronics</b> <b>AMP Shanghai Ltd</b>	PAGE	NO	108-60027	REV	LOC
		7			O	FB

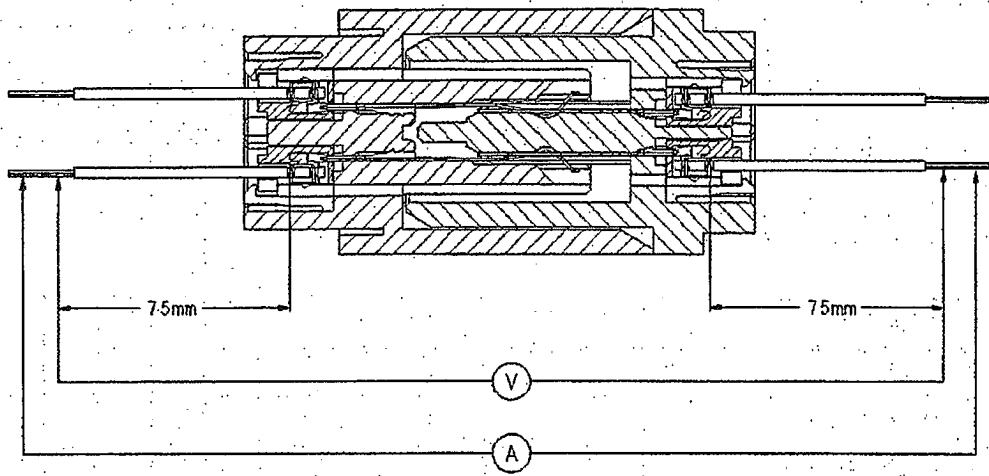

Fig. 4a: Signal Line Termination Resistance Measure Method

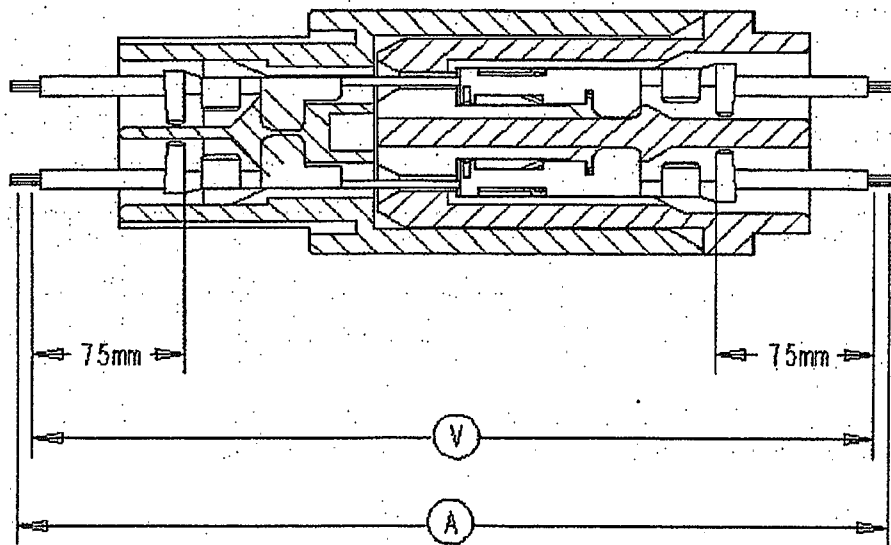



Fig. 4b: Power Line Termination Resistance Measurement Method

	<p>Tyco Electronics AMP Shanghai Ltd</p>	<p>PAGE 8</p>	<p>NO 108-60027</p>	<p>REV O</p>	<p>LOC FB</p>
---	--	-------------------	-------------------------	------------------	-------------------



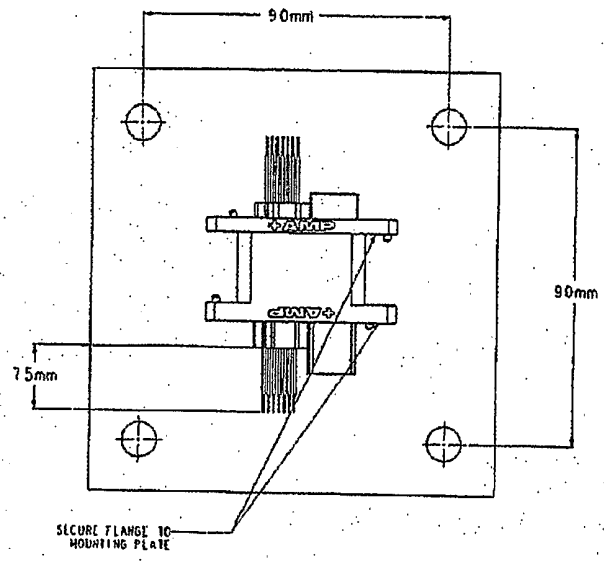

Fig. 5: Vibration/Physical Shock Mounting Method

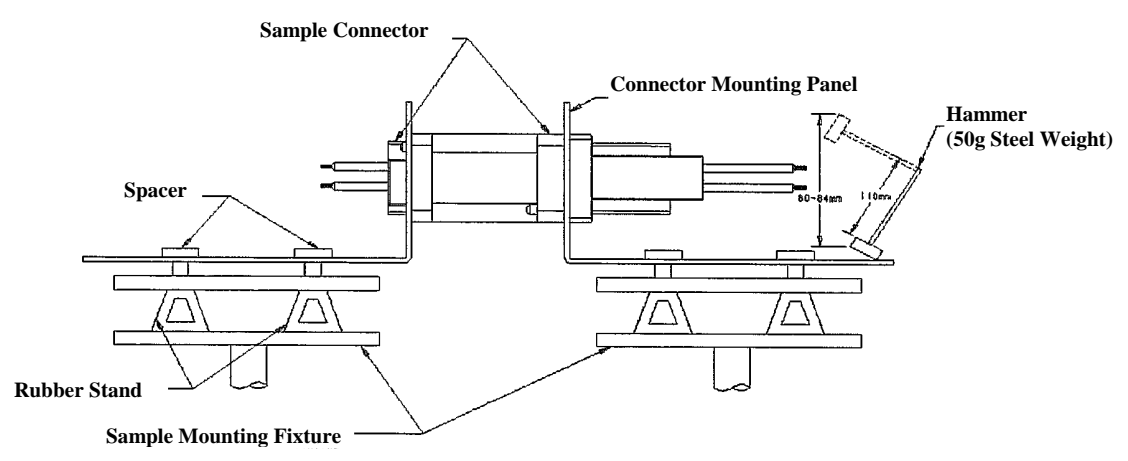

Fig. 6: Hammering Shock Test

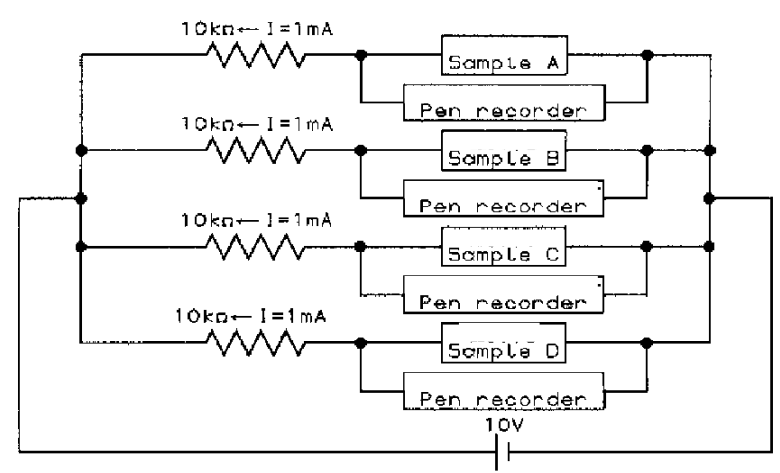

Fig. 7: Electrical Resistance Fluctuation Monitoring Circuit