

Product Specification

**.090III Series Multi-Lock I/O Connector
(Wire to wire type)**

1. Scope

1.1 Contents.

This specification covers the requirements for product performance, test methods and quality assurance provisions of **.090III Series Multi-Lock I/O Connector**.
The applicable product descriptions and part number are as follows:

Part Number	Descriptions
368083	Receptacle Contact (2.0 mm ²)
368084	Receptacle Contact (0.85 ~ 1.25 mm ²)
368085	Receptacle Contact (0.3 ~ 0.5 mm ²)
368086	Tab Contact (2.0 ~ 2.5 mm ²)
368087	Tab Contact (0.85 ~ 1.25 mm ²)
368088	Tab Contact (0.3 ~ 0.5 mm ²)
1743654	Receptacle Contact (0.3 ~ 0.5 mm ²)
1743655	Receptacle Contact (0.75 ~ 1.25 mm ²)
1743656	Receptacle Contact (1.5 ~ 2.0 mm ²)
1897598	Receptacle Contact (2.5 mm ²)
1897753	Receptacle Contact (0.22 mm ²)
1897752	Tab Contact (0.22 mm ²)
936224	.090III Series 2P. Plug
936227	.090III Series 4P. Plug
936230	.090III Series 6P. Plug
936268	.090III Series 6P. Plug
936233	.090III Series 8P. Plug
936092	.090III Series 10P. Plug
936196	.090III Series 12P. Plug
936199	.090III Series 14P. Plug
936201	.090III Series 16P. Plug
936204	.090III Series 18P. Plug
936095	.090III Series 20P. Plug
936151	.090III Series 22P. Plug

Part Number	Descriptions
936098	.090III Series 26P. Plug
936236	.090III Series 2P. Cap
936238	.090III Series 4P. Cap
936240	.090III Series 6P. Cap
936271	.090III Series 6P. Cap
936242	.090III Series 8P. Cap
936129	.090III Series 10P. Cap
936207	.090III Series 12P. Cap
936209	.090III Series 14P. Cap
936211	.090III Series 16P. Cap
936213	.090III Series 18P. Cap
936131	.090III Series 20P. Cap
936154	.090III Series 22P. Cap
936133	.090III Series 26P. Cap

Fig. 1

2. Applicable Documents.

The following documents form a part of this specification to the extent specified herein. In the event of conflict between the requirements of this specification and the product drawing, the product drawing shall take precedence. In the event of conflict between the requirements of this specification and the referenced documents, this specification shall take precedence.

2.1 AMP Specifications :

114-61004 Application Specification,.090 Series Rec. & Tab Contact
114-61014 Application Specification,.090III Series Rec.

2.2 Reference Documents :

JASO D 605 : Automotive Multi-pole Connectors
JASO D7101 : Test Methods for Molded Plastic Parts
JIS C 3406 : Low Voltage Cables for Automobiles
JIS D 0203 : Method of Moisture, Rain and Spray Test for Automobile Parts
JIS D 0204 : Method of High and Low Temperature Test for Automobile Parts
JIS D 1601 : Vibration Testing Method for Electronic Components
JIS D 0205 : General Rules of Weatherability for Automobile Testing
JIS K 2202 : Gasoline for Automobiles

2.3 Definition of Terms :

2.3.1 Contact :

An electrically conductive metallic member, used independently or as a component of a connector assembly to form circuit connection by contacting.

- 2.3.2 Housing :
A dielectric component member of a connector is made of insulating material that encapsulate contacts in its contact cavities. In this product line, cap housing that encapsulates tab contacts, and plug housing that encapsulates receptacle contacts are available.
- 2.3.3 Double Lock Plate :
Attached to the housing, this plate is intended to detect improper contact mating as well as to increase contact retention force.
- 2.3.4 Connector :
A connector is an assembly of housing and crimped wire contacts in all contact positions, and further equipped with double lock plate. In this product line, cap housing assembled with tab contact and plug housing assembled with receptacle contact.

3. Requirements :

- 3.1 Design and Construction :
Product shall be of the design, construction and physical dimensions Specified on the applicable product drawing.

3.2 Materials & Finish

A. Contact

Description	P/N	Material	Finish
REC	368083	CuNiSi-Alloy	Pre-tinned
	368084	CuNiSi-Alloy	Pre-tinned
	368085	CuNiSi-Alloy	Pre-tinned
	1743654	CuNiSi-Alloy	Pre-tinned
	1743655	CuNiSi-Alloy	Pre-tinned
	1743656	CuNiSi-Alloy	Pre-tinned
	1897598	CuNiSi-Alloy	Pre-tinned
	1897753	CuNiSi-Alloy	Pre-tinned
TAB	368086	Brass	Pre-tinned
	368087	Brass	Pre-tinned
	368088	Brass	Pre-tinned
	1897752	Brass	Pre-tinned

B. Housing and Double Lock Plate : Molded Polybutylene-terephthalate (PBT)

3.3 Ratings:

- A. Temperature Rating : -30°C to + 105°C
(Ambient Temperature+Temperature Rise due to energized current)

3.3.1 Applicable Wires :

Part No.	Applicable Wire
Contact	Conductor Size (mm ²)
368083	AVSS2.0
368084	CAVUS0.85-AVS1.25
368085	CAVUS0.3-AVS0.5
368086	AVSS2.0
368087	CAVUS0.85-AVS1.25
368088	CAVUS0.3-AVS0.5

1743654	CAVS0.3-AVSF0.5
1743655	AVSF0.75-AEXF1.25
1743656	AVS1.5-AVSSF2.0
1897598	AESSXF2.5
1897752	CHFUS0.22
1897753	CHFUS0.22

3.4 Performance and Test Descriptions :

The product is designed to meet the electrical, mechanical and environmental performance requirements specified in para. 3.5. All tests are performed at ambient temperature unless otherwise specified.

3.5 Test Requirements and Procedures Summary :

Para.	Test items	Requirements	Procedures
3.5.1	Appearance	There shall be no crack, rust, burr, damage, deformation, discoloration, etc. which is harmful to function.	Using sense of sight and touch
3.5.2	Connector Mating Force	No. of Pos	Mating Force Kg.f Max
		1p ~ 12p	10 kgf Max.
		13p ~ 22p	15 kgf Max.
		23p ~	18 kgf Max.
3.5.3	Reverse insertion between housings	It shall not be incorrectly inserted by applying force of 20 kgf of with hands.	Insert the housing with terminal by pushing it in reverse direction with applying 20 kgf.
3.5.4	Reverse insertion between terminal and housing	5.0 Kgf Max.	Crimp cable of maximum size on terminal and then insert it into housing by applying force of 5kgf or with hand in the reserve direction.
3.5.5	Engage force between terminal and housing	1.5 kgf Max.	Measure the weight while inserting terminal into fixed housing at 50mm/min speed.
Para.	Test items	Requirements	Procedures
3.5.6	HSG lock strength	10 kgf Min.	Combine housing only, fix the one side of housing in completely locked condition, and extend the other side in axial direction and 30 angle direction at a constant speed of 100 mm/min. Then measure weight when lock structure is disengaged or destroyed.

3.5.7	Lock release force	Force on release force point of lock part shall be 6kgf Max.	Apply force (F) to lock releasing part, and measure weight on the point of A=0. However, cut connector and then perform test at the section in order to secure visibility.
-------	--------------------	--	--

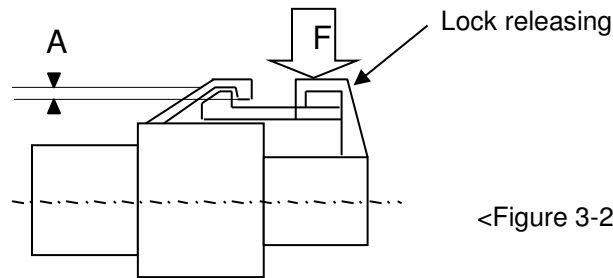

3.5.8	Terminal retention force	10 kgf Min.	Fix the housing after inserting crimped terminals. Extend one line of cable in axial direction at a speed of 100mm/min at a position 50~100mm away from crimped part, and measure weight when terminal is disengaged from the housing.
-------	--------------------------	-------------	--

3.5.9	Terminal engage and disengage force (kgf)	Engage	0.3~1.0	As shown in figure 3-3, engage and disengage male terminal or steel gauge into or from female terminal at 50 mm/min speed
		Disengage	0.15~1.0	

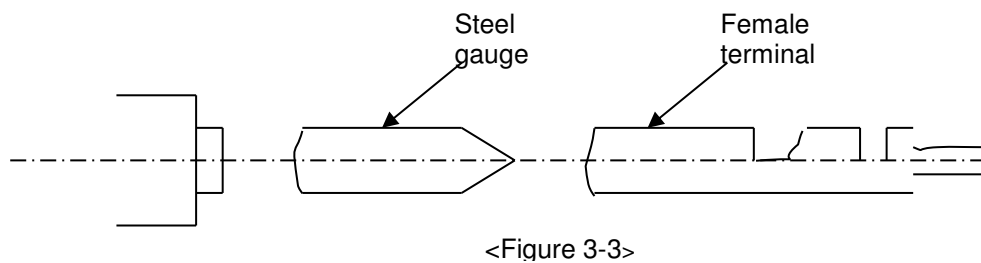

Para.	Test items	Requirements							Procedures
3.5.10	Crimp strength (kgf)	SQ	0.22	0.3	0.5	0.85	1.25	2.0	Fix the crimped terminal, and draw the cable at a position 50~100mm away from crimped part in axial direction at 100 mm/min speed. Then measure the weight when cable is cut or disengaged from the crimped part.
		More Than	4	6	9	13	17	20	

3.5.11	Voltage drop	Initial	After endurance	Measure the circuit voltage drop (V) by sending voltage and current described in the table 5-1 with terminal combined on the connector. Then calculate a voltage drop (V_D) in terminal by subtracting cable resistance (L) from the circuit voltage drop (V).
		3 mV/A Max.	10 mV/A Max.	

1) HARNESS versus HARNESS : $V_D = V - (L_1 + L_2)$

2) HARNESS versus UNIT : $V_D = V - (L_3 + L_4)$

Application	Open voltage	Short circuit current	Division
Signal circuit	20 ± 5 mV	10 mA	ECU, Sensor
Power circuit	13 V	1 A	Other than the above

< Table 1 >

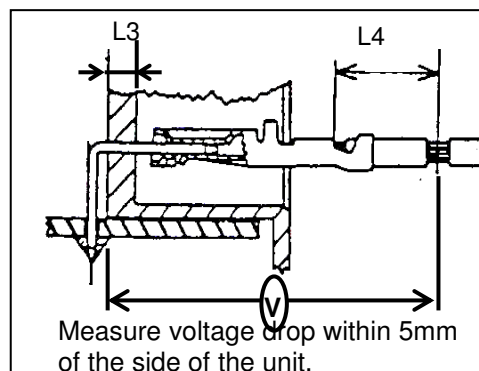
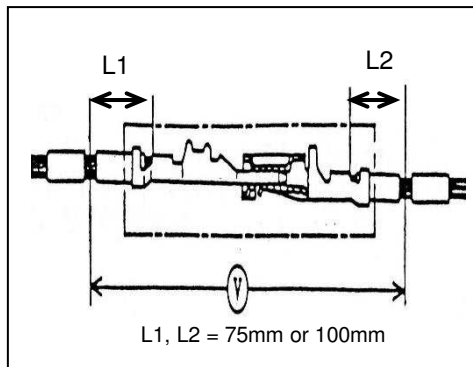

< Figure 3-4 : HARNESS versus HARNESS > < Figure 3-5 : HARNESS versus UNIT >

3.5.12	Insulation resistance	Initial	After endurance	Measure resistance between neighbor terminals (figure 3-6), and between terminal and housing surface (figure 3-7) with DC 500V insulation resistance gauge with connector combined
		100 M Ω Min.	10 k Ω Min.	

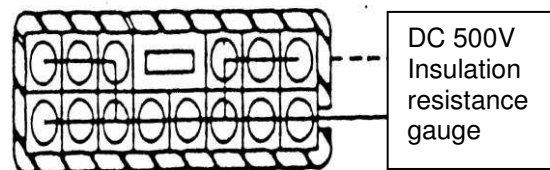
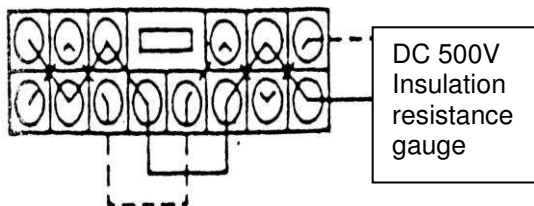

<Figure 3-6:Between neighboring terminals>

<Figure 3-7:Between neighboring terminal and housing surface>

Para.	Test items	Requirements		Procedures
		Initial	After endurance	
3.5.13	Leakage current	10 μ A Max.	1 mA Max.	Measure it by applying DC 13V between neighboring terminals (figure 3-6).
3.5.14	High voltage test	There shall be no insulation break		Apply AC 1000V voltage of normal frequency for 1 minute between neighboring terminals (figure 3-6), and between housing surfaces of terminal (figure 3-7), with connector combined.
3.5.15	Temperature rise	After endurance 40°C Max.		Apply basic current ($I=I_0 \cdot K$) of clause 4.3 to the connector with electrodes in series in the room free from wind (normal temperature). And measure a temperature of crimped part after reaching saturation temperature. Then calculate a temperature of crimped part by subtracting ambient temperature from the temperature.
3.5.16	Instant short circuit	There shall be no 10 μ s Min. instant short circuit.		It is instant short circuit, when 3.5V or less voltage continues for 10 μ s or more in gauge by applying 1 mA, 5V open voltage. Figure 3-8 is an example of measured circuit.

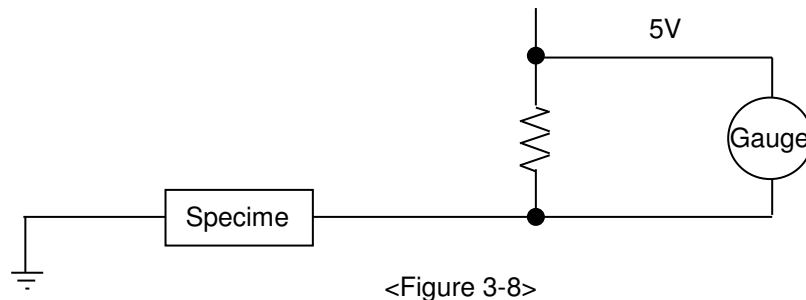

<Figure 3-8>

< Table 1 : Test items >

Test items	Appearance	CONN insertion and drawing force	HSG reverse insertion	Reverse insertion between terminal and HSG	Engage force between terminal and HSG	Connector clip engage/disengage force	Strength of HSG LOCK	HSG LOCK release force	Terminal retention force	Terminal engage/disengage force	Crimp strength	Voltage drop	Insulation resistance	Leakage current	High voltage	Temperature rise	Instant short circuit	Sealing
Initial test	0	0	0	0	0	0	0	0	0	0	0	0	0	0	0			
Twisting test	0											0						
Connector engage /disengage endurance test	0											0						
Overcurrent cycle test A	0											0				0		
Overcurrent cycle test B	0											0				0		
Cold temperature test	0											0	0	0		0		0
Cold and hot temperature shock test	0											0						0
High temperature test	0											0						0
Soldering test	0																	
Temperature and humidity cycle test	0											0	0	0				0
Dust test												0						0
Waterproof test	0												0	0				0
Oil and liquid test	0											0						0
Ozone test	0											0						0
Salt water test	0											0	0	0				
Sulfur test	0											0						0
Mechanical shock test																	0	
Complex environment endurance test A	0										0	0				0	0	
Complex environment endurance test B	0										0	0				0	0	0

4. Test Condition

4.1 Specimen

Unless specifically mentioned, initial sample shall be used for test specimen. Test specimen shall be 5EA or more for each cavity. However, if performance is expected to be clearly satisfactory even by applying load to the same specimen in turn, it is possible to apply multiple test items to the same specimen. In such case, performance shall be satisfactory for each item.

4.2 Laboratory condition

Perform each test at designated temperature and humidity. And control humidity at designated absorption ratio for the connector which uses absorbent resin housing.

Temperature: 25 ± 5 °C

Humidity: 60 ± 20%

4.3 Basic current

Basic current value "I" shall be based on the following. ($I = I_0 * K$)

Cable size (SQ)	I ₀		Remarks
	General	L TYPE (375)	
0.22	4 A		
0.3	6 A		4A for signal
0.5	8 A		5A for signal
0.85	10 A		
1.25	14 A		
2.0	18 A		
3.0	22 A	34 A	
5.0	25 A	46 A	
8.0		60 A	

< Table 4.1 >

Number of simultaneous electrode within the same connector	K
	Reduction factor
1	1
2 ~ 3	0.75
4 ~ 5	0.6
6 ~ 8	0.55
9 ~ 10	0.5
11 ~ 25	0.4
26 or more	0.3
-	-

< Table 4.2 >

4.4 Evaluation

Evaluation of connectors shall be represented by evaluation of connectors of the maximum number of poles in the same series.

4.5 Cable size

The size of connector lead wire used in each test shall be follow Table 4.3

5. Test Method

5.1 Twisting test

Apply 8kgf force on the end part of combined connector 10 times each in the (front, rear, left, right) directions perpendicular to axial direction.

5.2 Connector engage and disengage endurance test

Make combine connectors engage and disengage at 100mm/min. Perform it 50 times. (Do not use locking device)

5.3 Over-current cycle test

Engage and disengage connector with terminal assembled 10 times with hands, and apply the following current 1000 cycles for the connector with electrodes in series at 60 °C of ambient temperature.

Current application condition A	Applied current	2 times of basic current
	Current application time	1 minute - ON, 9 minutes - OFF
Current application condition B	Applied current	5 times of basic current
	Current application time	10 seconds - ON, 590 seconds - OFF

5.4 Cold temperature test

Engage and disengage connector with terminal assembled 10 times with hands, and leave it in temperature chamber of -40°C for 120 hours. Make connector engaged and disengaged 5 times immediately, and drop it onto the concrete surface from 1m height 3 times in the direction of figure 5-1.

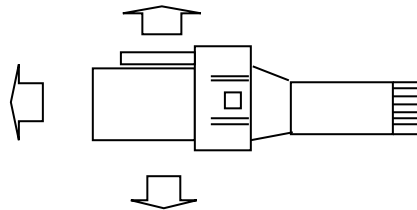

<Figure 5-1>

5.5 Cold and hot temperature shock test

Engage and disengage connector with terminal assembled 10 times with hands, and leave it in combined state at -40°C for 2 hours, and perform 200 cycles according of the method specified in the figure 5-2. Then leave it at room temperature for 2 hours or more ((*) follows table 5-1.).

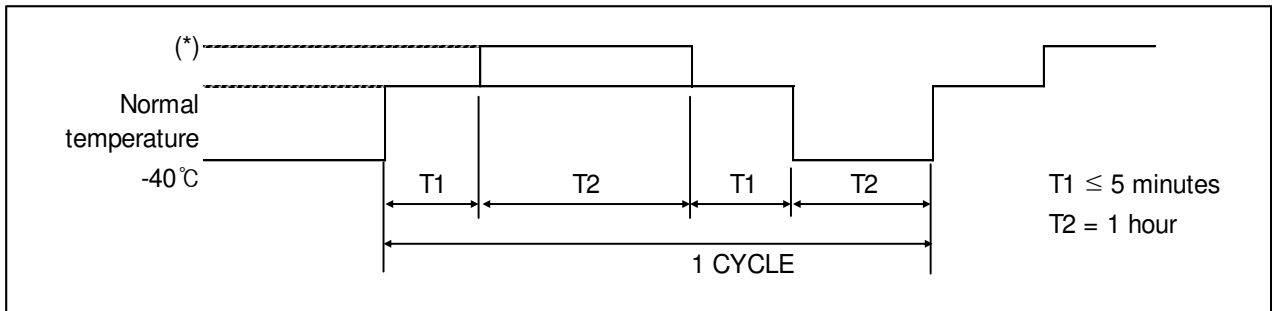

< Figure 5-2 : Test pattern >

Division	High temperature (*)	Connector using part
A	120°C	waterproof connector
B	80°C	Non-waterproof connector

< Table 5-1 >

5.6 High temperature test

Engage and disengage connector with terminal assembled 10 times with hands, and leave it in combined state at the temperature chamber of the table 5-1 for 300 hours. Then pick it out and leave it until it returns to normal temperature.

5.7 Soldering test (Connector Attached to Unit Directly)

Deposit the soldering part of TM'L post coming out of connector in the solder deposition tank at $250 \pm 5^\circ\text{C}$ for 5 or less seconds. Deposition depth is up to 1.5mm from connector main body. (Satisfied an appearance quality and apply 95% or more.)

5.8 Temperature Humidity test

Engage and disengage connector with terminal assembled 10 times with hands, and leave it at 25°C ambient temperature and 65% relative humidity for 25 hours. And perform 5 cycles of the method specified in figure 5-3. Then pick connector out of chamber and dry it for 2 hours or more.

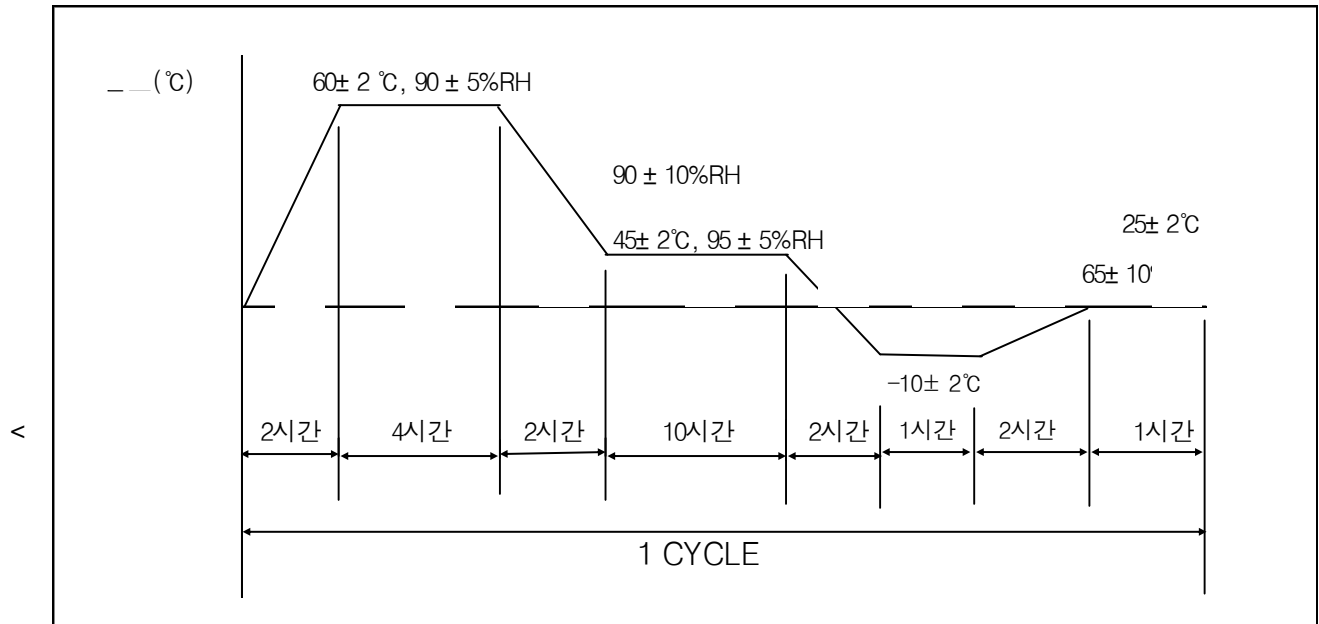

< Figure 5-3 : Test pattern >

5.9 Temperature Humidity test

Engage and disengage connector with terminal assembled 10 times with hands, and diffuse 1.5kg Portland cement(JIS R5210) with fan (or others) for 10 seconds per 15 minutes while maintaining 150mm distance from wall in the closed container of 900~1200mm length, width and height, with connector combined. After 1 hour, engage and disengage it three times.

5.10 Oil and liquid test

Engage and disengage connector with terminal assembled 10 times with hands, and perform test in the following order with connector combined.

- A. Immerse connector in combined state for 2 hours in mixed oil of $50 \pm 2^\circ\text{C}$ ENG oil (SAE 10W) or equivalent oil and
- B. Immerse connector in combined state for 1 hour in car gasoline (JIS K2202) at normal temperature, and then pick it out.
- C. Immerse connector in combined state for 1 hour in brake liquid (pure product) at normal temperature, and then pick it out.
- D. Immerse connector in combined state for 1 hour in 100% washer liquid (pure product) at normal temperature, and then pick it out.
- E. Immerse connector in combined state for 1 hour in 50% LLC (Long life coolant) at normal temperature, and then pick it out.

5.11 Ozone test

Engage and disengage connector with terminal assembled 10 times with hands, and expose it in combined state to ozone of 40°C 50 ± 5 pphm for 100 hours. Then pick connector out of chamber and dry it for 2 hours or more.

5.12 Sulfur gas test

Engage and disengage connector with terminal assembled 10 times with hands, and expose it in combined state to ozone of 40°C 50 ± 5 ppm for 100 hours. Then pick connector out of chamber and dry it for 2 hours or more.

5.13 Mechanical shock test

Engage and disengage connector with terminal assembled 10 times with hands, and apply 1960,3920,5880,9822 m/s² shock in each direction of figure 5-5 and 5-6 using assembled male and female samples. Perform test in current application condition of DC13V open voltage and 10mA short circuit current.

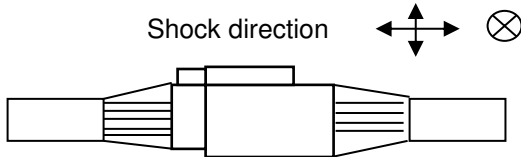

<Figure 5-5>

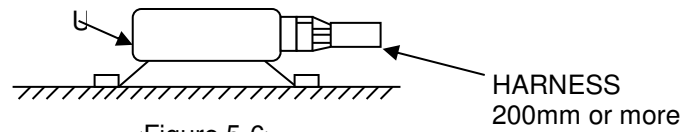

<Figure 5-6>

5.14 Complex environment endurance test (Refer to the attached test process #1)

Engage and disengage connector with terminal assembled 10 times with hands, and leave it in combined state in the temperature chamber of 120°C or 80°C (follows table 5-1) for 48 hours. And then perform the following vibration test. Then measure instant short circuit according to the method of clause 3.5.16 for 4 hours for X, Y, Z each.

Follow figure 5-7 for connector attaching method.

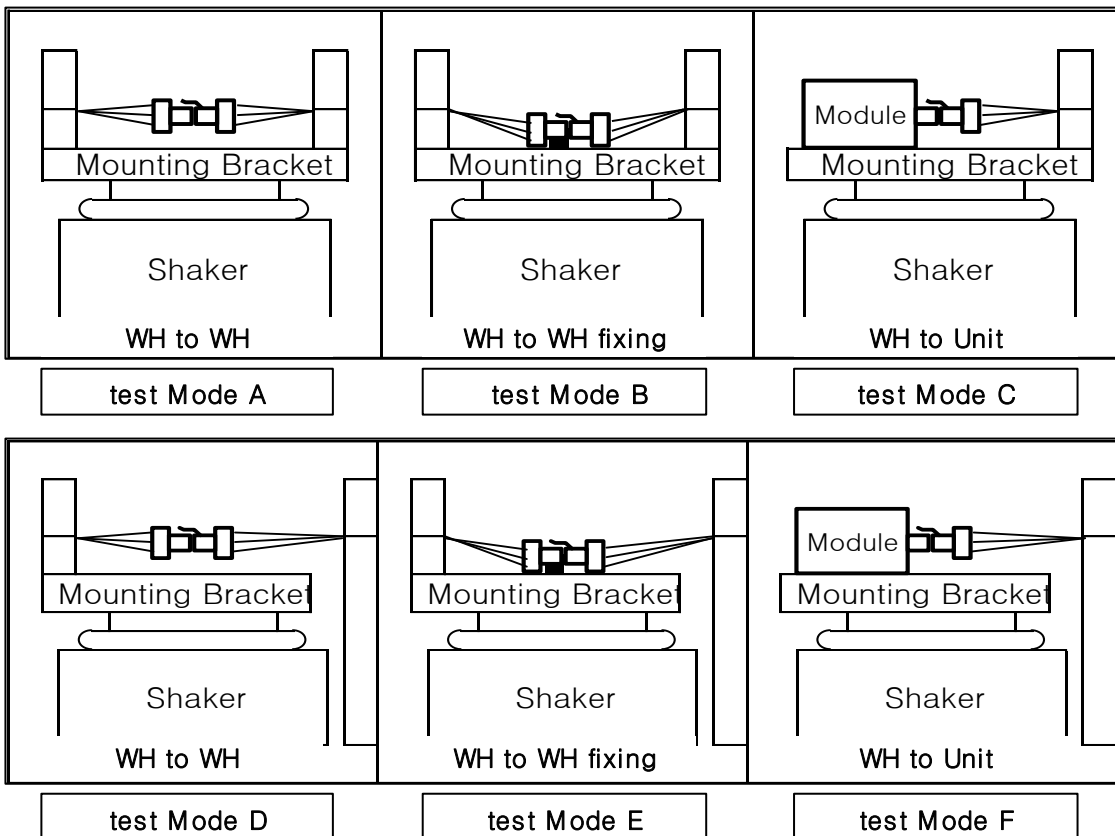

<Figure 5-7 Connector attaching method>

◆ Vibration test A (for non-waterproof connector)

Division	Condition
Ambient temperature/humidity	80 °C, 90~95%
Applied current	Basic current (Connect electrodes in series.)
Current application cycle	120 CYCLE (45 minutes-ON, 15 minutes-OFF)
Vibration acceleration	4.4 g
Frequency	20 Hz ~ 200 Hz (Sweep time : 3 minutes or less)
Vibration time	40 hours for X, Y, Z each
Connector attaching method	Test Mode A, B, C

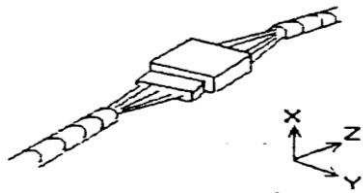

<Figure 5-8 : X, Y, Z vibration direction>

2) Random wave test

Perform this test for the component of which sine wave test has been finished.

Division	Condition
Ambient temperature	120 °C
Applied current	Basic current (Connect electrodes in series.)
Current application cycle	24 CYCLE (45 minutes-ON, 15 minutes-OFF)
Vibration acceleration	Follow figure 5-10
Vibration time	8 hours for X, Y, Z each
Connector attaching method	Test Mode D, E, F

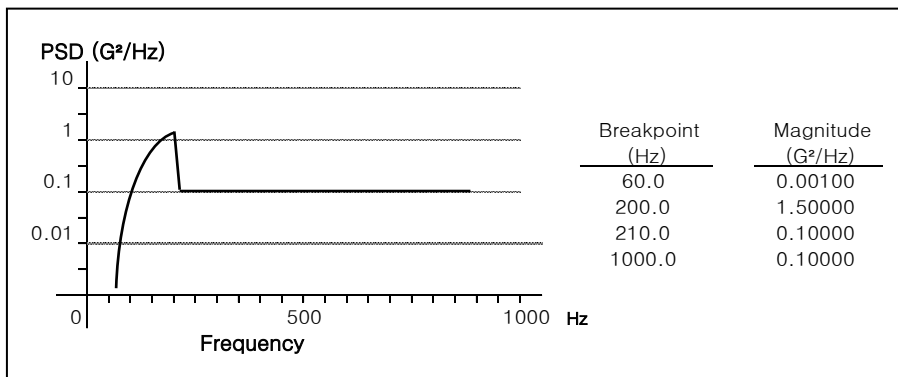

<Figure 5-10>

SPECIFICATION APPROVAL

Prepared by,

YD.LEE

Product Engineer

Checked By,

YM CHOI

Product Engineering Manager

Approved by,

HG CHO

Product Engineering Director