

Class 1

HVP800 2PHI AND 3PHI 180° AMP+ High Current Connectors

TABLE OF CONTENTS INHALTSVERZEICHNIS



1. SCOPE.....	6
ANWENDUNGSBEREICH.....	6
1.1 Introducing.....	6
Einfuehrung.....	6
1.2 Content.....	6
Inhalt	6
1.3 Qualification.....	6
Qualifikation.....	6
2. APPLICABLE DOCUMENTS	7
ANWENDBARE UNTERLAGEN	7
2.1 TE Connectivity Documents	7
TE Connectivity Unterlagen.....	7
2.1.1 General Requirements	7
Generelle Anforderungen	7
2.1.2 Customer drawings.....	8
Kundenzeichnungen.....	8
2.1.3 Specifications	10
Spezifikationen	10
2.2 Other Documents	11
Allgemeine Unterlagen.....	11
3. REQUIREMENTS	12
ANFORDERUNGEN	12
3.1 Design and Construction	12
Entwurf und Konstruktion	12
3.2 Material.....	12
Werkstoff	12
3.3 Ratings	12
Nenngroessen	12
3.4 Performance and Test Description	13
Leistung und Testdurchfuehrung.....	13
3.5 Test Requirements and Procedures Summary.....	14
Testanforderungen und Testergebnisse.....	14
3.6 Additional Test Procedures and Test Results.....	20
Zusaetzliche Testdurchfuehrungen und Testergebnisse.....	20
4. QUALITY ASSURANCE PROVISIONS.....	21
QUALITAETSSICHERUNGSMASSNAHMEN	21
4.1 Qualification Testing	21
Qualifikationspruefung.....	21
4.2 Requalification Testing	21
Requalifikationspruefung.....	21
4.2.1 Acceptance.....	21
Abnahme.....	21
4.2.2 Quality Conformance Inspection	21

Pruefung der Qualitaetskonformitaet.....	21
5. APPENDIX	22
ANHANG	22
5.1 Housing influence on derating: 2pos connector.....	22
Gehaeuseeinfluss auf Derating: 2pol. Steckverbinder.....	22
5.2 Housing influence on derating: 3pos connector.....	24
Gehaeuseeinfluss auf Derating: 3pol. Steckverbinde.....	24
5.3 Dynamic load.....	31
Dynamische Beanspruchung.....	31
5.4 Contact engagement length	32
Kontaktueberdeckung	32
5.5 Strain Relief.....	33
Leitungsabfangung.....	33

LIST OF FIGURES

Figure 1: 25mm ² (Coroplast-No. 9-2611) Derating and temperature rise – current at shield.	22
Figure 2: 35mm ² (Coroplast-No. 9-2611) Derating and temperature rise – current at shield.	23
Figure 3: 50mm ² (Coroplast-No. 9-2611) Derating and temperature rise – current at shield.	23
Figure 4: 25mm ² (Coroplast-No. 9-2611) Derating and temperature rise – current at shield.	25
Figure 5: 35mm ² (Coroplast-No. 9-2611) Derating and temperature rise – current at shield.	25
Figure 6: 50mm ² (Coroplast-No. 9-2611) Derating and temperature rise – current at shield.	26
Figure 7: 16mm ² (Coficab Silicon-No. FHLR2GCB2G) Derating and temperature rise – current at shield	26
Figure 8: 25mm ² (Coficab Silicon-No. FHLR2GCB2G) Derating and temperature rise – current at contact	27
Figure 9: 35mm ² (Coficab Silicon-No. FHLR2GCB2G) Derating and temperature rise – current at contact	27
Figure 10: 50mm ² (Coficab Silicon-No. FHLR2GCB2G) Derating and temperature rise – current at contact.....	28
Figure 11: 50mm ² (Coficab XPO-No. HL3XCBX50HHH) Derating and temperature rise – current at shield.....	28
Figure 12: 50mm ² (HUBER+SUHNER. No. FHLR4GC13X) Derating and temperature rise – current at shield.....	29
Figure 13: 50mm ² (HUBER+SUHNER. No. FHLR4GC13X) Derating and temperature rise – 10A current at shield.....	30
Figure 14: Vibration device (exemplary view at 2pos. connector).....	31
Figure 15: Contact engagement length.....	32
Figure 16: Recommended requirement for strain relief	33

ABBILDUNGSVERZEICHNIS

Abbildung 1: 25mm ² (Coroplast-No. 9-2611) Derating und Stromerwaermung - Schirmung	22
Abbildung 2: 35mm ² (Coroplast-No. 9-2611) Derating und Stromerwaermung - Schirmung	23
Abbildung 3: 50mm ² (Coroplast-No. 9-2611) Derating und Stromerwaermung – Schirmung.....	23
Abbildung 4: 25mm ² (Coroplast-No. 9-2611) Derating und Stromerwaermung – Schirmung.....	25
Abbildung 5: 25mm ² (Coroplast-No. 9-2611) Derating und Stromerwaermung – Schirmung.....	25
Abbildung 6: 50mm ² (Coroplast-No. 9-2611) Derating und Stromerwaermung - Schirmung	26
Abbildung 7: 16mm ² (Coficab Silicon-No. FHLR2GCB2G) Derating und Stromerwaermung - Strom bei Kontakt.....	26
Abbildung 8: 25mm ² (Coficab Silicon-No. FHLR2GCB2G) Derating und Stromerwaermung - Strom bei Kontakt.....	27
Abbildung 9: 35mm ² (Coficab Silicon-No. FHLR2GCB2G) Derating und Stromerwaermung - Strom bei Kontakt.....	27
Abbildung 10: 50mm ² (Coficab Silicon-No. FHLR2GCB2G) Derating und Stromerwaermung - Strom bei Kontakt.....	28
Abbildung 11: 50mm ² (Coficab XPO-No. FHLR91XCB91X) Derating und Stromerwaermung – Strom bei Kontakt.....	28
Abbildung 12: 50mm ² (HUBER+SUHNER. No. FHLR4GC13X) Derating und Stromerwaermung - Strom bei Kontakt.....	29
Abbildung 13: 50mm ² (HUBER+SUHNER. No. FHLR4GC13X) Derating und Stromerwaermung – 10A Schirmunstrom.....	30
Abbildung 14: Vibrationsvorrichtung (exemplarische Darstellung mit 2 pol. Stecker)	31
Abbildung 15: Kontaktueberdeckung	32
Abbildung 16: Empfohlene Anforderungen Leitungsabfangung	33

LIST OF TABLES

Table 1: General Requirements	7
Table 2: Customer drawings	8
Table 3: TE-Specifications	10
Table 4: References	11
Table 5: Product Ratings	12
Table 6: Test Requirements and procedures Summary	14
Table 7: Additional test requirements	20

TABELLENVERZEICHNIS

Tabelle 1: Generelle Anforderungen	7
Tabelle 2: Kundenzeichnungen	8
Tabelle 3: TE-Spezifikationen	10
Tabelle 4: Referenzen	11
Tabelle 5: Produktmerkmale	12
Tabelle 6: Testanforderung und Ergebnisse	14
Tabelle 7: Zusätzliche Testanforderungen	20

ONLY THE ENGLISH VERSION IS AUTHORITATIVE

Massgebend ist der englische Text

1. SCOPE

ANWENDUNGSBEREICH

1.1 Introducing

Einfuehrung

TE Connectivity's touch-proof 2-3 position high current connectors HVP800 are designed to meet WG 4.3.3, LV215-1 specifications. With a wire size range from 16mm² up to 50mm² (acc. to LV216-2) meet the sealed connector systems the AK category 2. The connectors are used with interfaces TE 114-94032, 114-94034 and 114-94040.

With a 180° cable outlet incorporates the HVP800 connector system two or three (2-3pos) 8mm power contacts and an integrated High Voltage Interlock (HVIL) System. The HVP800 connector is available for four different keying or polarizing configurations and incorporates conductive EMI shields to reduce radiated emissions in the application. Assembly is simplified with a lever assist for low insertion force and the housings are molded in orange to denote a high voltage system.

TE Connectivity's beruehrgeschuetzter 2-3pos. Hochstromsteckverbinder HVP800 sind nach der Designrichtlinie LV215-1 des AK 4.3.3 entwickelt. Mit einem Leitungsbereich von 16mm² bis zu 50mm² (gem. LV216-2) entspricht das gedichtete Stecksystem der AK Kategorie 2. Die Stecker sind eingesetzt mit Schnittstellen TE 114-94032, 114-94034 and 114-94040. Mit einem Leitungsabgang von 180° beinhaltet der HVP800 zwei oder drei (2-3pos) 8mm Leistungskontakte und ein integriertes Hochvolt-Interlock (HVIL) System. Zur Reduzierung der abgestrahlten Emissionen in der Applikation ist das gedichtete HVP800 Stecksystem mit Schirmblechen ausgefuehrt und ist vier Kodierungen bzw. Polarisierungen verfuegbar. Die Montage wird durch einen Hebel vereinfacht und zur Kennzeichnung der Hochvoltanwendung sind die Gehaeuse in orange ausgefuehrt.

1.2 Content

Inhalt

This specification covers performance, tests and quality requirements for the TE Connectivity 2-3 position high current connector HVP800 with 180° Plug assembly.

However, this specification covers no requirements or tests to the contact systems, for more detailed information see corresponding TE-Specifications in chapter 2.1.3.

Diese Spezifikation beschreibt die Eigenschaften, Tests und Qualitätsanforderungen fuer den TE Connectivity 2-3pol Steckverbinder HVP800 mit 180° Buchsengehaeuse.

Jedoch beinhaltet diese Spezifikation keine Anforderungen oder Tests zu den Kontaktsystemen, fuer naehere Informationen sind die entsprechenden aufgefuehrten TE-Spezifikationen in Kapitel 2.1.3 einzusehen.

1.3 Qualification

Qualifikation

When tests are performed the following specifications and standards shall be used. All inspections shall be performed using the applicable inspection plan and customer drawing.

Die nachfolgenden Pruefungen sind nach den genannten Richtlinien und Normungen einzuhalten und muessen nach den zugehoerigen Pruefplaenen und Kundenzeichnungen durchgefuehrt werden.

2. APPLICABLE DOCUMENTS ANWENDBARE UNTERLAGEN

The following mentioned documents are part of this specification. Unless otherwise specified, the latest edition of the documents applies. In the event of conflict between the requirements of this specification and the information contained in the referenced documents, this specification shall take precedence.

Die nachfolgenden Unterlagen, sofern darauf verwiesen wird, sind Teil dieser Spezifikation. Falls nicht anders spezifiziert sind die jeweils letztgueltigen Dokumente anzuwenden. Im Falle des Widerspruches zwischen dieser Spezifikationen oder Informationen von anderen technischen Dokumentationen, hat diese Spezifikation Vorrang.

2.1 TE Connectivity Documents TE Connectivity Unterlagen

2.1.1 General Requirements Generelle Anforderungen

Table 1: General Requirements
Tabelle 1: Generelle Anforderungen

Requirements <i>Requirements</i>	Description <i>Beschreibung</i>
TEC-109-1 Rev. J	General Requirements for Test Specifications <i>Generelle Anforderungen fuer Testspezifikationen</i>

2.1.2 Customer drawings
Kundenzeichnungen

Table 2: Customer drawings
Tabelle 2: Kundenzeichnungen

2 pos. HVP 800 180° Connector 2 pol.HVP 800 180° Steckverbinder	
2177052	2 Pos. 8mm HV, REC HSG 180° Kit, Overview, not for sale 2 pol. 8mm HV, REC HSG 180° Kit, UEbersicht, nicht zum Verkauf
2177053	2 Pos, 8mm HV, REC HSG 180°, Assy 2 pol. 8mm HV, REC HSG 180°, Assy
2286939	2 Pos, HV, Cable Assy, 25mm² 2 pol. HV, Leitungs- Assy, 25mm ²
2286938	2 Pos, HV, Cable Assy, 35mm² 2 pol. HV, Leitungs- Assy, 35mm ²
2286937	2 Pos, HV, Cable Assy, 50mm² 2 pol. HV, Leitungs- Assy, 50mm ²

3 pos. HVP 800 180° Connector 3 pol. HVP 800 180° Steckverbinder	
2177062	3 Pos. 8mm HV, REC HSG 180° Kit, Overview, not for sale 3 pol. 8mm HV, REC HSG 180° Kit, UEbersicht, nicht zum Verkauf
2177063	3 Pos, 8mm HV, REC HSG 180°, Assy 3 pol. 8mm HV, REC HSG 180°, Assy
2286935	3 Pos, HV, Cable Assy, 25mm² 3 pol. HV, Leitungs- Assy, 25mm ²
2286932	3 Pos, HV, Cable Assy, 35mm² 3 pol. HV, Leitungs- Assy, 35mm ²
2286917	3 Pos, HV, Cable Assy, 50mm² 3 pol. HV, Leitungs- Assy, 50mm ²

2pos Pinheader 2pol Stiftwanne	
2141227	2 Pos. Dia 8mm Pin housing, Assy 2 pol. Rundkontakt 8mm Stiftwanne, Assy
2349467	2 Pos. Dia 8mm Pin housing, Assy (V0 version) 2 pol. Rundkontakt 8mm Stiftwanne, Assy

3pos Pinheader 3pol Stiftwanne	
2141230	3 Pos. Dia 8mm Pin housing, Assy 3 pol. Rundkontakt 8mm Stiftwanne, Assy

Single Components used at 2 and 3 pos. HV-CLASS 4, 180° Connector Einzelkomponenten verwendet im 2 und 3 pol HV-CLASS 4, 180° Steckverbinder	
2141155	Cover, Seal Abdeckkappe, Dichtung
2141156	Single Wire Seal Einzelleitungsdichtung
2177090	Shield Crimp Ferrule Schirmcrimphuelse
2177061	Upper Shield Crimp Ferrule Unterschirmcrimphuelse
2413297	Shielding sleeve Schirmhuelse
2177058	Insulation insert Isolationskoerper
2177059	Finger protection cap Fingerschutzkappe
2208608	HV 8mm Socket Terminal 180° HV 8mm Buchsenkontakt 180°
2208669	HV 8mm Socket Terminal 180° HV 8mm Buchsenkontakt 180°

Interface drawings Schnittstellenzeichnungen	
114-94032	Interface aggregate cut-out for 2/3pos. HVP 800 90°/180° Pin housing Schnittstelle Aggregatausschnitt fuer 2/3pol. HVP 800 90°/180° Stiftwanne
114-94034	Plug board pin Dia. 8mm, 2/3pos. HV, 90°/180° Steckerleiste 8mm Rundpin, 2/3pol. HV, 90°/180°
114-94040	Pin Dia. 8mm Rundkontakt 8mm

2.1.3 Specifications
Spezifikationen

Table 3: TE-Specifications
Tabelle 3: TE-Spezifikationen

Specification Spezifikation	Description Beschreibung
108-94255	Product Specification HV 8MM 180° Turned contact Produktspezifikation HV 8mm 180° Dreh-Kontakt
108-18782	Product Specification MCON-1.2 Contact System Produktspezifikation MCON-1.2 Kontaktsystem
114-18464	Application Specifications MCON-1.2 Contact System Verarbeitungsspezifikation MCON-1.2 Kontaktsystem
114-94130	Application Specification HVP800 180° Verarbeitungsspezifikation HVP800 180°
108-94451	Product Specification HV 8MM 180° Stamped contact Produktspezifikation HV 8mm 180° Stanz-Kontakt
114-94325	Application Specification for 8mm Round stamped contact System Verarbeitungsspezifikation fuer 8mm Stanz-Rundkontaktsystem

2.2 Other Documents

Allgemeine Unterlagen

Table 4: References
Tabelle 4: Referenzen

Document number <i>Dokumentnummer</i>	Edition <i>Datum</i>	Standard: Title, Author <i>Norm: Titel, Autor</i>
DIN EN 60664-1	2008-01	Isolation coordination for equipment within low-voltage systems - Part 1: Principles, requirements and tests <i>Isolationskoordinaten fuer elektrische Betriebsmittel in Niederspannungsanlagen Niederspannungsanlagen Teil 1: Grundsätze, Anforderungen und Pruefungen</i>
DIN 40050-9	1993-05	IP-Schutzarten, Degrees of protection (IP-Code) - Protection of electrical equipment against foreign objects, water and access <i>IP- Schutzarten, Schutz gegen Fremdkoerper, Wasser und Beruehren Elektrischer Ausruestung</i>
ISO 20653	2006-08	Road vehicles - Degrees of protection (IP-Code) - Protection of electrical equipment against foreign objects, water and access <i>Strassenfahrzeuge, IP-Schutzarten, Schutz gegen Fremdkoerper, Wasser und Beruehren Elektrischer Ausruestung</i>
ISO 6469-3	2001-1	Electric road vehicles – Safety specifications. Part 3: Protection of person against electric hazards <i>Strassenfahrzeuge – Sicherheitspezifikation Teil 3: Schutz von Personen gegen elektrische Gefahren</i>
SAE J 1742	1998-03 (2005-12)	Connections for High Voltage On-Board Road Vehicle, Electrical Wiring Harnesses Test Methods and General Performance Requirements
LV 214-1	2010-03	Test specification for motor vehicle connectors <i>AK Pruefrichtlinie fuer Kfz-Steckverbinder</i>
LV 215-1	2009-02	Electrical/Electronic Requirements of HV Connectors <i>Elektrik / Elektronik Anforderungen an HV-Steckverbinder</i>
LV 216	-	HV cables, unshielded/shielded Un-/geschirmte HV-Mantelleitung, ein-/mehradrig
ISO 19642-9	-	HUBER+SUHNER, Shielded cable HUBER+SUHNER, Automotive Leitung geschirmt,

3. REQUIREMENTS
ANFORDERUNGEN

3.1 Design and Construction
Entwurf und Konstruktion

The product design, construction and physical dimensions shall correspond to the latest customer drawings.

However, prototype parts or pre-serial parts can be differing slightly in dimensioning, form- and position tolerances to the interface drawings.

Das Produkt muss in seiner Ausfuehrung und seinen physikalischen Abmessungen den letztgueltigen Kundenzeichnungen entsprechen.

Jedoch koennen Prototypen- oder Vorserienteilen in geringfuegigen Bereichen von den Massen, Form- und Lagetoleranzen der Schnittstellenzeichnungen abweichen.

3.2 Material
Werkstoff

Descriptions for material see latest valid customer drawings.

Angaben hierzu sind den letztgueltigen Kundenzeichnungen zu entnehmen.

3.3 Ratings
Nenngroessen

Table 5: Product Ratings
Tabelle 5: Produktmerkmale

Description Beschreibung	Range Wert
Max working voltage at 5500m above sea level Max. Betriebsspannung bei 5500m ue. NN	≤ 1000VDC
Voltage class acc. ISO 6469-3 Spannungsklasse nach ISO 6469-3	B
Class 1 equipment acc. ISO 6469-3 Ausruestungsklasse nach ISO 6469-3	1
Dielectric withstand voltage acc. ISO 6469-3 Bemessungs-Stosspannung nach ISO 6469-3	3000V
Insulation resistance acc. ISO 6469-3, SAE J 1742 Isolationswiderstand nach ISO 6469-3, SAE J 1742	> 200MΩ

Isolation Group I and II acc. DIN EN 60664-1 <i>Isoliergruppe I und II nach DIN EN 60664-1</i>	600 ≤ CTI – components with direct contact to HV 400 ≤ CTI ≤ 600
Pollution Degree acc. DIN EN 60664-1 <i>Verschmutzungs Grad nach DIN EN 60664-1</i>	2
Clearance distance at 5500m above sea level acc. DIN EN 60664-1 <i>Luftstrecke bei 5500m ue. NN nach DIN EN 60664-1</i>	> 3.40mm
Creepage Distance acc. DIN EN 60664-1 <i>Kriechstrecke nach DIN EN 60664-1</i>	> 5.00mm
Ambient temperature <i>Umgebungstemperatur</i>	-40°C to 140°C *
Degrees of protection (IP-Code) against access acc. ISO 20653, unmated situation <i>Schutzgrade gegen Beruehren gefaehrlicher Teile nach ISO 20653, nicht gesteckter Zustand</i>	IPX2B
Degree of protection (IP-Code) against foreign objects and water acc. ISO 20653, mated situation <i>Schutzgrade gegen Eindringen fester Fremdkoerper und Wasser nach ISO 20653, gesteckter Zustand</i>	IP6K9K, IP6K7
Color of plastic housing <i>Farbe der Kunststoffgehaeuse</i>	Orange similar RAL 2003 <i>Orange aehnlich RAL 2003</i>

* Except for Coficab XPO-No. HL3XCBX50HHH, temperature limit is 125°C

3.4 Performance and Test Description

Leistung und Testdurchfuehrung

The product is designed to meet the electrical, mechanical and environmental performance requirements specified in table 6 and table 7. Unless otherwise specified, all tests shall be performed at ambient environmental conditions according to TE-TEC 109-1.

Das Produkt erfuellt die in Tabelle 6 und Tabelle 7 aufgefuehrten elektrischen, mechanischen und klimatischen Anforderungen. Falls nicht naeher spezifiziert sind alle Pruefungen bei Raumtemperatur und entsprechend der TE-TEC 109-1 Richtlinie durchgefuehrt.

3.5 Test Requirements and Procedures Summary
Testanforderungen und Testergebnisse

Not shown test-details see LV 214 (released 2010-03) and LV215-2 (release 2013-03)
Nicht angegebene Einzelheiten der Pruefungen siehe LV214 (Stand 2010-03) und LV215-2 (Stand 2013-03).

Table 6: Test Requirements and procedures Summary
Tabelle 6: Testanforderung und Ergebnisse

Test Description <i>Testbeschreibung</i>	Requirement <i>Anforderung</i>	Procedure <i>Verfahren</i>
PG 0 RECEIVING INSPECTION EINGANGSPRUEFUNG		
E 0.1 Visual inspection <i>Sichtpruefung</i>	Basic function proven <i>Grundfunktion gegeben</i>	LV215-2 DIN EN 60512-1-1
E 0.2 Contact resistance <i>Durchgangswiderstand</i>	<ul style="list-style-type: none"> ● Contact $\leq 0.36m\Omega$ (50mm²); $\leq 0.39m\Omega$ (35mm²); $\leq 0.40m\Omega$ (25mm²) Kontakt $\leq 0.36m\Omega$ (50mm²); $\leq 0.39m\Omega$ (35mm²); $\leq 0.40m\Omega$ (25mm²) ● HVIL-contact $\leq 15m\Omega$ <i>HVIL-Kontakt $\leq 15m\Omega$</i> ● Shielding cable – Header $< 7m\Omega$ <i>Schirmung Leitung - Stiftleiste $< 7m\Omega$</i> 	LV215-2 DIN EN 60512-2-1
E 0.3 Insulation resistance <i>Isolationswiderstand</i>	<ul style="list-style-type: none"> ● Insulation resistance at 1kVDC: $>200M\Omega$ <i>Isolationswiderstand bei 1kVDC: $>200M\Omega$</i> 	LV215-2 DIN EN 60512-3-1
PG 4 CONTACT OVERLAPPING KONTAKTUEBERDECKUNG		
E 4.1 Contact engagement length <i>Kontaktueberdeckung</i>	Values see appendix 5.3 <i>Werte siehe Anhang 5.3</i>	Theoretical study <i>Theoretische Studie</i>
PG 6 INTERACTION BETWEEN CONTACT AND HOUSING <i>WECHSELWIRKUNG ZWISCHEN KONTAKT UND GEHAEUSE</i>		
E 6.1 Deflection of contacts in the housing cavity <i>Taumelspiele der Kontakte in der Gehaeusekammer</i>	<ul style="list-style-type: none"> ● No damage during joining <i>Keine Moeglichkeit der Schaedigung beim Fuegen</i> 	Theoretical study <i>Theoretische Studie</i>
B6.1 Drop test	<ul style="list-style-type: none"> ● Drop test from 1m height; No damages or impairments of function 	LV215-2 DIN EN 60068-2-31

<p>Falltest</p>	<p>Falltest aus 1m Hoehe; Keine Beschadigungen, die die Gebrauchstauglichkeit beeinflussen</p>	
<p>PG 7</p> <p>HANDLING AND FUNCTIONAL RELIABILITY OF THE HOUSINGS HANDHABUNG UND FUNKTIONSSICHERHEIT DER GEHAEUSE</p>		
<p>E 7.1 Error-proof design of housings Unverwechselbarkeit der Gehaeuse</p>	<ul style="list-style-type: none"> ● Coding/Polarisation Test load: 300N Kodierung/Polarisierung Pruefkraft: 300N 	<p>LV214 DIN EN 60512-13-5</p>
<p>E 7.2 Retention force of the housing latch/lock Haltekraft der Gehaeuseverrastung / Gehaeuseverriegelung</p>	<ul style="list-style-type: none"> ● Retention force of the housing catch mechanism / housing interlock: >250N Haltekraft der Gehaeuseverrastung / Gehaeuseverriegelung: >250N 	<p>LV215-2 DIN EN 60512-15-6</p>
<p>E 7.3 Functionality of CPA Funktion der CPA</p>	<ul style="list-style-type: none"> ● Actuation force activating: 5 - 30N Betaetigungskraft Aktivieren: 5 - 30N ● Actuation force opening: 5 - 30N Betaetigungskraft Oeffnen: 5 - 30N ● CPA Efficiency: >80N CPA-Effizienz: >80N 	<p>LV214</p>
<p>E 7.4 Insertion force or actuation force for insertion with removal aids Steckkraft bzw. Betaetigungskraft bei Steck- und Ziehhilfen</p>	<p>Insertion and actuation force: ≤ 75N Steck- und Betaetigungskraft: ≤ 75N</p>	<p>LV214</p>
<p>PG 8</p> <p>MATING AND RETENTION FORCE OF CONTACT PARTS EINSTECK- UND HALTEKRAEFTE DER KONTAKTTEILE</p>		
<p>E 8.1 Contact insertion forces Kontakteinsteckkraefte</p>	<p>Cable assy with 8mm-contact: Insertion force ≤ 50N Kabel-Assy mit 8mm-Kontakt: Einsteckkraft ≤ 50N</p>	<p>LV214</p>
<p>E 8.2 Contact removal force from the housing Kontaktausreisskraft aus dem Gehaeuse</p>	<p>Primary lock and Secondary lock measured separately Primaer- und Sekundaerverriegelung getrennt gemessen</p> <p>Cable assy with 8mm-contact Kabel-Assy mit 8mm-Kontakt ≥ 180N HVIL-contact HVIL-Kontakt ≥ 55N</p>	<p>LV214</p>

PG 9 SKEWED INSERTION ANGLE SCHRAEGSTECKWINKEL		
E 9.2 Max. possible insertion inclination Max. moeglicher Schraegsteckwinkel	Max. possible insertion inclination warrants the contacting without damage Max. moeglicher Schraegsteckwinkel garantiert die Kontaktpaarung ohne Schaedigung	Theoretical study Theoretische Studie
E 9.3 Koshiri Safety UEberpruefung Gehaeuse auf Koshiri-Sicherheit	Live parts must only touch its counter-part while mounting (including insertion chamfers). In case of incorrect insertion of the plug no live parts must be touched. Signal- und stromfuehrende Bauteile duerfen bei Montage nur mit Ihrem Gegenstueck beruehrt werden koennen. Auch bei fehlerhaftem Einstecken duerfen Kontakte nicht beruehrt werden.	Theoretical study Theoretische Studie
PG 11 MATING CYCLES STECKHAEUEFIGKEIT		
B 11.1 Mating cycles Steckhaeufigkeit	<ul style="list-style-type: none"> • Connector with HVIL-Contacts 50 Cycles Stecker mit Interlockkontakten 50 Zyklen 	LV214
PG 13 * DERATING GEHAEUSEEINFLUSS AUF DIE STROMERWAERMUNG		
E 13.2 Derating with housing Derating im Gehaeuse	<ul style="list-style-type: none"> • Dependent on application and cable type different values are possible Abhaengig von Anwendung, Ausfuehrung und Leitungstyp koennen sich verschiedene Werte ergeben • Max. temperature at contacts 180°C Grenztemperatur Kontakte 180°C • Derating see appendix 5.1 Werte siehe Anhang 5.1 	LV215-2 DIN EN 60512-5-1/2
PG 17* DYNAMIC LOAD DYNAMISCHE BEANSPRUCHUNG		
B 17.2 Dynamic Load; broad-band random Dynamische Beanspruchung: Breitbandrauschen	<ul style="list-style-type: none"> • Severity 2: "Body" sealed; Details see appendix 5.2 Schaerfeegrad 2: "Karosserie" gedichtet; Details siehe Anhang 5.2 • Slight wear, surface ok. Leichte Abnutzung, Oberflaeche i.O. • Resistances after testing Durchgangswiderstand nach Test: • Contact Kontakt $\leq 0.72m\Omega$ • HVIL-contact HVIL-Kontakt $\leq 15m\Omega$ 	LV214 DIN EN 60068-2-64

	<ul style="list-style-type: none"> ● Shielding cable - aggregate < 7mΩ Schirmung Leitung - Aggregat < 7mΩ 	
B 17.3 Endurance shock test Dauerschocken	<ul style="list-style-type: none"> ● 30g; T=6ms; N=6000 ● Slight wear, surface ok. Leichte Abnutzung, Oberflaeche i.O. ● Resistances after testing Durchgangswiderstand nach Test: ● Contact Kontakt ≤ 0.72mΩ ● HVIL-contact HVIL-Kontakt ≤ 15mΩ ● Shielding cable - aggregate < 7mΩ Schirmung Leitung - Aggregat < 7mΩ 	LV214 DIN EN 60068-2-27
<p>In the event of particularly critical installation conditions, special agreements shall be made between the manufacturer and the user. Bei besonders kritischen Einbaubedingungen sind gesonderte Vereinbarungen zwischen Hersteller und Anwender zu treffen.</p>		
PG18C DICING SALT LOAD STREUZSALZ-BEANSPRUCHUNG		
B 18.3 Salt spray, cyclic Salznebel, zyklisch	<ul style="list-style-type: none"> ● Resistances after Salt spray test, not sealed Durchgangswiderstaende nach Salznebeltest, ungedichtet: ● Contact Kontakt ≤ 0.72mΩ ● HVIL-contact HVIL-Kontakt ≤ 15mΩ ● Shielding cable - aggregate < 7mΩ Schirmung Leitung - Aggregat < 7mΩ 	LV215-2 DIN EN 60068-2-52 (SG3)
PG20 * CLIMATIC LOAD OF HOUSINGS KLIMATISCHE BEANSPRUCHUNG DER GEHAEUSE		
B 20.1 Dry heat Trockene Waerme	<ul style="list-style-type: none"> ● Dry heat 120h / 140°C Trockene Waerme 120h / 140°C 	LV214
B 20.2 Damp heat Feuchte Waerme	<ul style="list-style-type: none"> ● Damp heat 10 days / 40°C / 95% rel. humidity Feuchte Waerme 10 Tage / 40°C / 95% Luftf. ● Insulation resistance at 1kVDC: >200MΩ Isolationswiderstand bei 1kVDC: >200MΩ 	LV214
B 20.3 Climatic cold Kaeltelagerung	<ul style="list-style-type: none"> ● Climatic cold 48h / -40°C Kaeltelagerung 48h / -40°C ● Plugging / unmating possible at -20°C Stecken / Ziehen bei -20°C moeglich 	LV214
B 20.1 Dry heat Trockene Waerme	<ul style="list-style-type: none"> ● Dry heat 48h / 80°C Trockene Waerme 48h / 80°C 	LV214
<p>* Except for Coficab XPO-No. HL3XCBX50HHH, temperature limit is 125°C</p>		

<p>B6.1 Drop test after aging Falltest nach Alterung</p>	<ul style="list-style-type: none"> ● Drop test from 1m height; No damages or impairments of function Falltest aus 1m Hoehe; Keine Beschädigungen, die die Gebrauchstauglichkeit beeinflussen 	<p>LV215-2 DIN EN 60068-2-31</p>
<p>PG21 * LONG-TERM AGING LANGZEITTEMPERATURLAGERUNG</p>		
<p>B 21.1 Long-term aging in dry heat Langzeitlagerung bei trockener Waerme</p>	<ul style="list-style-type: none"> ● 1000h at 140°C ; Resistances after aging: 1000h bei 140°C ; Durchgangswiderstaende nach Alterung: ● Contact Kontakt ≤ 0.72mΩ ● HVIL-contact HVIL-Kontakt ≤ 15mΩ ● Shielding cable - aggregate < 7mΩ Schirmung Leitung - Aggregat < 7mΩ ● Functionality; Contact Removal forces acc. E8.2 Funktionalitaet; Kontaktausreisskraefte nach E8.2 	<p>LV215-2 DIN EN 60068-2-2</p>
<p>PG22B CHEMICAL RESISTANCE CHEMISCHE BESTAENDIGKEIT</p>		
<p>B 22.1B Chemical Resistance (water-tight design) Chemische Bestaendigkeit (gedichtete Ausfuehrung)</p>	<ul style="list-style-type: none"> ● Application of media for 48h at specified temperature; only tested at single parts Beaufschlagung fuer 48h bei spezifizierter Temperatur; getestet an Einzelteilen ● No textural or dimensional change, no impairments of function Keine strukturelle oder dimensionelle Veraenderung, keine Beeintraechtigung der Funktion. ● Insulation resistance >100MΩ Isolationswiderstand >100MΩ 	<p>LV214</p>
<p>PG23 * WATERTIGHTNESS WASSERDICHTHEIT</p>		
<p>B 19.3 Aging in dry heat Lagerung bei trockener Waerme</p>	<ul style="list-style-type: none"> ● 120h at 140°C 120h bei 140°C 	<p>DIN EN 60068-2-2</p>
<p>B 19.1 Temperature shock Temperaturschock</p>	<ul style="list-style-type: none"> ● Period: 144cycles -40°C / +140°C* each 15min Dauer: 144 Zyklen -40°C / +140°C*, je 15min 	<p>DIN EN 60068-2-14</p>
<p>B 23.1 Immersion with pressure difference Tauchen mit Druckdifferenz</p>	<ul style="list-style-type: none"> ● Low pressure: -100mbar, holding time 5min. -500mbar, holding time 5min. Unterdruck: -100mbar, Haltezeit 5min. -500mbar, Haltezeit 5min. 	<p>LV214 DIN EN 60512-14-5</p>
<p>* Except for Coficab XPO-No. HL3XCBX50HHH, temperature limit is 125°C</p>		

<p>B 23.2 Immersion with pressure difference <i>Leitungsbewegung bei Tauchen mit Druckdifferenz</i></p>	<ul style="list-style-type: none"> • Movement of cable at low pressure: -100mbar, holding time 5min. -500mbar, holding time 5min. • <i>Leitungsbewegung bei Unterdruck:</i> -100mbar, Haltezeit 5min. -500mbar, Haltezeit 5min. 	<p>LV214 DIN EN 60512-14-5</p>								
<p>B 23.3 Thermal shock test <i>Thermoschockpruefung</i></p>	<ul style="list-style-type: none"> • 30min. in 120°C air; 15min in 0°C Water 5 cycles • <i>30min in 120°C Luft; 15min. in 0°C Wasser</i> <i>Zykluszahl: 5</i> 	<p>LV214</p>								
<p>B 23.4 °ree of protection test/pressure washer test <i>Schutzartpruefung / Dampfstrahlpruefung</i></p>	<ul style="list-style-type: none"> • Severity: IP X9K <i>Schaerfegrad IP X9K</i> • Test duration per side: 15s Distance to nozzle: 10 - 15 cm Pressure: 80 bar Temperature: 80°C • <i>Pruefdauer je Seite: 15s</i> <i>Abstand zur Duese: 10 – 15cm</i> <i>Druck: 80bar</i> <i>Temperatur: 80°C</i> 	<p>LV214 DIN 40050-9</p>								
<p>E 0.3 Insulation resistance <i>Isolationswiderstand</i></p>	<ul style="list-style-type: none"> • Insulation resistance at 500VDC: >100MΩ <i>Isolationswiderstand bei 500VDC: >100MΩ</i> 	<p>LV215-2 DIN EN 60512-3-1</p>								
<p>PG28 LOCKING NOISE VERRIEGELUNGSGERAEUSCH</p>										
<p>E 28.1 Locking Noise <i>Verriegelungsgeraeusch</i></p>	<ul style="list-style-type: none"> • Locking noise ≥70dB(A) <i>Verriegelungsgeraeusch ≥70dB(A)</i> 	<p>LV214</p>								
<p>PG50 EMC- ELECTROMAGNETIC COMPATIBILITY EMV-PRUEFUNG</p>										
<p>PG50 EMC- Electromagnetic compatibility <i>EMV- Elektromagnetische Vertraeglichkeit</i></p>	<table border="1"> <thead> <tr> <th>Frequency Frequenz</th> <th>Delta-Transferimpedance Delta-Transferimpedanz</th> </tr> </thead> <tbody> <tr> <td>DC</td> <td><2mΩ</td> </tr> <tr> <td>2MHz</td> <td><10mΩ</td> </tr> <tr> <td>30MHz</td> <td><60mΩ</td> </tr> </tbody> </table>	Frequency Frequenz	Delta-Transferimpedance Delta-Transferimpedanz	DC	<2mΩ	2MHz	<10mΩ	30MHz	<60mΩ	<p>VG 95214-11 LV215-1 LV215-2</p>
Frequency Frequenz	Delta-Transferimpedance Delta-Transferimpedanz									
DC	<2mΩ									
2MHz	<10mΩ									
30MHz	<60mΩ									
<p>PG51 IP PROTECTION OPEN CONNECTOR BERUEHRSCHUTZ</p>										
<p>PG51 Protection open connector <i>Schutz vor Beruehrung; nicht gesteckt</i></p>	<ul style="list-style-type: none"> • IP-protection IPXXB, un-mated (VDE test finger Ø12mm) IP-protection IPXXD, mated <i>IP- Schutzgrad IPXXB, ungesteckt (VDE-Testfinger Ø12mm)</i> <i>IP- Schutzgrad IPXXD, gesteckt</i> 	<p>ISO 20653</p>								

* Except for Coficab XPO-No. HL3XCBX50HHH, temperature limit is 125°C

3.6 Additional Test Procedures and Test Results
Zusätzliche Testdurchführungen und Testergebnisse

Table 7: Additional test requirements
Tabelle 7: Zusätzliche Testanforderungen

Test Description <i>Testbeschreibung</i>	Requirement <i>Anforderung</i>	Procedure <i>Verfahren</i>
A1 Crimp validation PG1 <i>Crimpvalidierung PG1</i>	<ul style="list-style-type: none"> ● Pull out force shield crimp: >150 N <i>Ausreisskraft Schirmcrimp: >150 N</i> ● Cross section examination: crimp sleeves are well formed <i>Schliffbild: Verformung der Crimphuelse in Ordnung</i> 	TE-Spec. 109-18212 <i>TE-Spec. 109-18212</i>
A2 Crimp validation PG2 <i>Crimpvalidierung PG2</i>	<ul style="list-style-type: none"> ● Shield resistance <3 mOhm <i>Schirmuebergangswiderstand <3 mOhm</i> 	TE-Spec. 109-18212 <i>TE-Spec. 109-18212</i>
<ul style="list-style-type: none"> ● Cable used for crimp validation Coroplast-No.: 9-2611 / 25, 35 and 50mm², Version A4 <i>Crimpvalidierung in Verbindung mit Leitung Coroplast-Nr.: 9-2611 / 25, 35 and 50mm², Revision A4</i> 		
<ul style="list-style-type: none"> ● Cable used for crimp validation Coficab Silicone-No.: FHRLR2GCB2G / 16, 25, 35 and 50mm², Version E <i>Crimpvalidierung in Verbindung mit Leitung Coficab Silicone-Nr.: FHRLR2GCB2G / 16, 25, 35 and 50mm², Revision E</i> 		
<ul style="list-style-type: none"> ● Cable used for crimp validation Coficab XPO-No.: 9-2611 / 50mm², Version E <i>Crimpvalidierung in Verbindung mit Leitung Coficab XPO-Nr.: 9-2611 / 50mm², Revision E</i> 		
<ul style="list-style-type: none"> ● Cable used for crimp validation HUBER+SUHNER-No.: 84 096 257 / 50mm², Version E ** <i>Crimpvalidierung in Verbindung mit Leitung HUBER+SUHNER-Nr.: 84 096 257 / 50mm², Revision E</i> 		
Test Description <i>Testbeschreibung</i>	Requirement <i>Anforderung</i>	Procedure <i>Verfahren</i>
A3 Retention force further connector parts <i>Haltekraft sonstiger Gehäuseteile</i>	<ul style="list-style-type: none"> ● Protection cover for single wire seal: >500 N <i>Schutzkappe fuer Einzeladerdichtung: >500 N</i> ● Finger protection cap (2177059): >100 N <i>Fingerschutz (2177059): >100 N</i> 	DIN IEC 60512-8 <i>DIN IEC 60512-8</i>
A4 Insertion force further connector parts <i>Einsteckkraft sonstiger Gehäuseteile</i>	<ul style="list-style-type: none"> ● Insertion force Protection cover for single wire seal: <50 N <i>Einsteckkraft Schutzkappe fuer Einzeladerdichtung: <50 N</i> ● Finger protection cap (2177059): <100 N <i>Fingerschutzkappe (2177059): <100 N</i> 	DIN IEC 60512-8 <i>DIN IEC 60512-8</i>

** Not recommended for automotive use

4. QUALITY ASSURANCE PROVISIONS

QUALITAETSSICHERUNGSMASSNAHMEN

4.1 Qualification Testing

Qualifikationspruefung

The samples shall be prepared in accordance with product drawings. They shall be selected at random from current production.

Die Prueflinge muessen den Zeichnungsunterlagen entsprechen. Sie sind der laufenden Produktion zufaellig zu entnehmen.

4.2 Requalification Testing

Requalifikationspruefung

If changes significantly affecting form, fit, or function depending on the product or manufacturing process, product engineering shall coordinate requalification testing, consisting of all or part of the original testing sequence as determined by development/product, quality, and reliability engineering.

Falls signifikante Eigenschaftsaenderungen der Form, Ausstattung oder Funktion des Produktes, sowie dessen Herstellungsverfahren vorgenommen werden, muss ein entsprechender Requalifikationstest durchgefuehrt werden. Dieser kann je nach Festlegung der Entwicklungs- und Qualitaetssicherungsabteilung aus einem Teil oder den gesamten urspruenglichen Pruefgruppen bestehen.

4.2.1 Acceptance

Abnahme

Acceptance is based on verification that the product meets the requirements of chapter 4. Failures attributed to equipment, test setup, or operator deficiencies shall not disqualify the product. When product failure occurs, corrective action shall be taken and samples resubmitted for qualification. Testing to confirm corrective action is required before resubmittal.

Die Abnahme basiert auf dem Nachweis, dass das Produkt den Anforderungen nach Kapitel 4 genuegt. Abweichungen, die auf Messgeraete, Messanordnungen oder Bedienungsmaengel zurueckzufuehren sind, duerfen nicht zum Entzug der Qualifikation fuehren. Tritt eine Abweichung auf, muessen korrigierend Massnahmen ergriffen werden und die Qualifikation ist erneut nachzuweisen. Vor dieser Requalifikation ist durch entsprechende Pruefungen der Erfolg der Korrekturmassnahme zu bestaetigen.

4.2.2 Quality Conformance Inspection

Pruefung der Qualitaetskonformitaet

The applicable quality inspection plan will specify the sampling acceptable quality level to be used. Dimensional and functional requirements shall be in accordance with the applicable product drawing and this specification.

Die Konformitaetspruefung erfolgt nach dem zugehoerigen Qualitaetsinspektionsplan, der die annehmbare Qualitaetsgrenzlage nach dem Stichprobenumfang festlegt. Massliche und funktionelle Anforderungen muessen mit den Produktzeichnungen und dieser Spezifikation uebereinstimmen.

5. APPENDIX
ANHANG

5.1 Housing influence on derating: 2pos connector
Gehäuseeinfluss auf Derating: 2pol. Steckverbinder

Derating inside housing: Current at contact with load at shield
Derating im Gehäuse: Kontaktbestromung mit Schirmbelastung

Cable length according to DIN EN 60512-5-2
Leitungslänge nach DIN EN 60512-5-2

Test setup

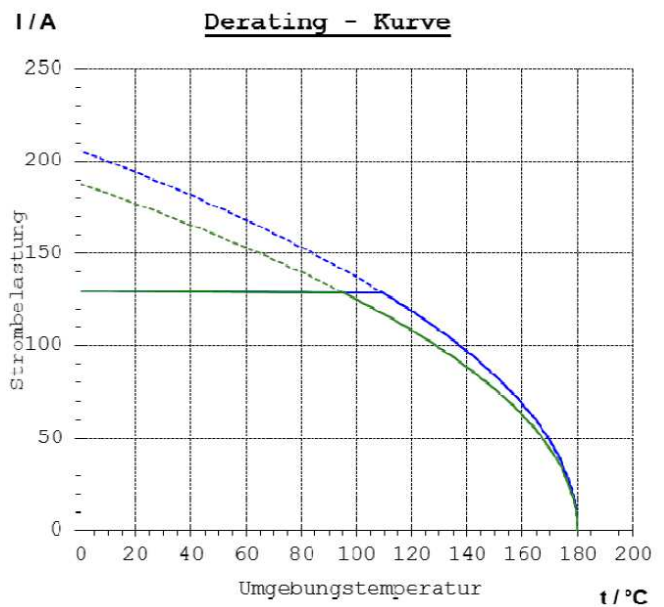
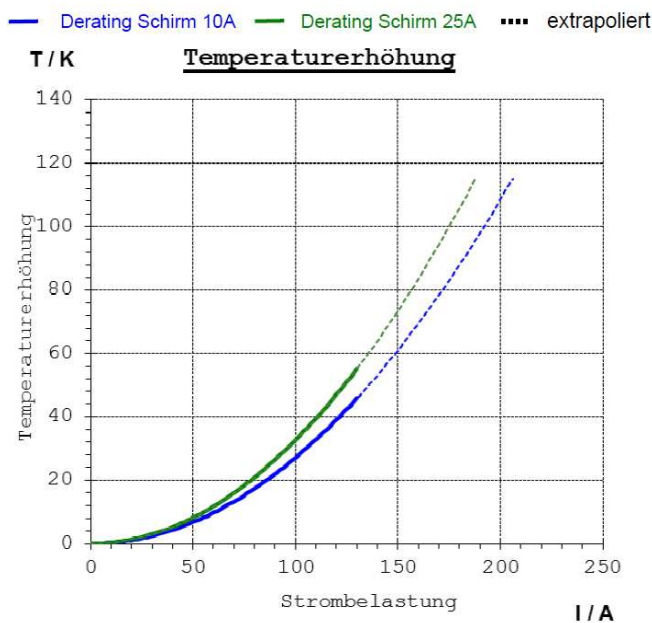
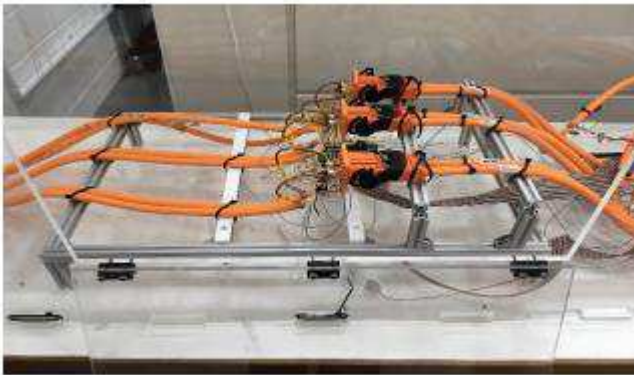

Figure 1: 25 mm² (Coroplast-No. 9-2611) Derating and temperature rise – current at contact
Abbildung 1: 25 mm² (Coroplast-No. 9-2611) Derating und Stromerwaerung - Strom bei Kontakt

— Derating Schirm 10A — Derating Schirm 25A extrapoliert

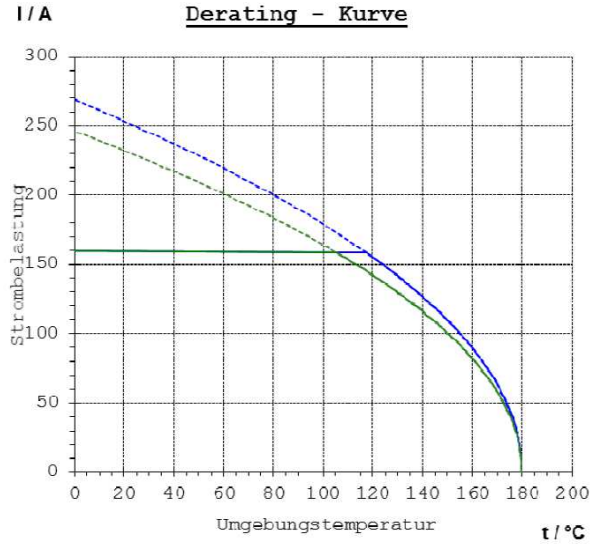
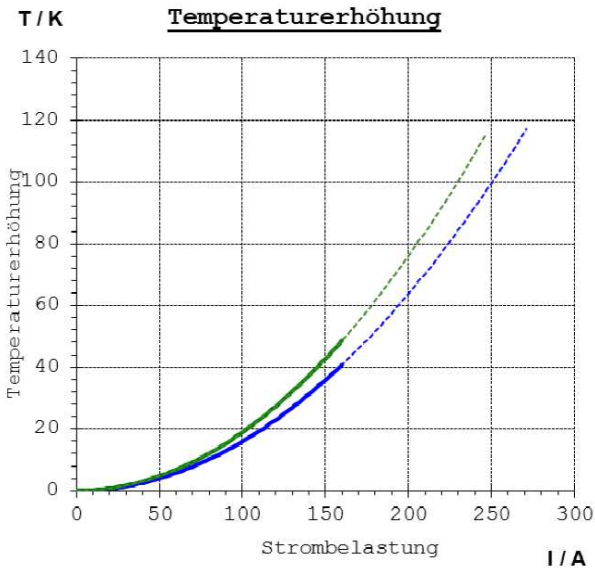

Figure 2: 35 mm² (Coroplast-No. 9-2611) Derating and temperature rise – current at contact
Abbildung 2: 35 mm² (Coroplast-No. 9-2611) Derating und Stromerwaermung - Strom bei Kontakt

— Derating Schirm 10A — Derating Schirm 25A extrapoliert

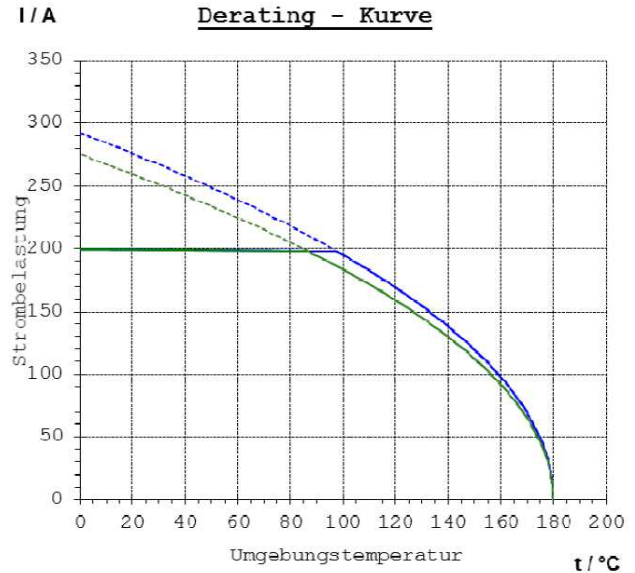
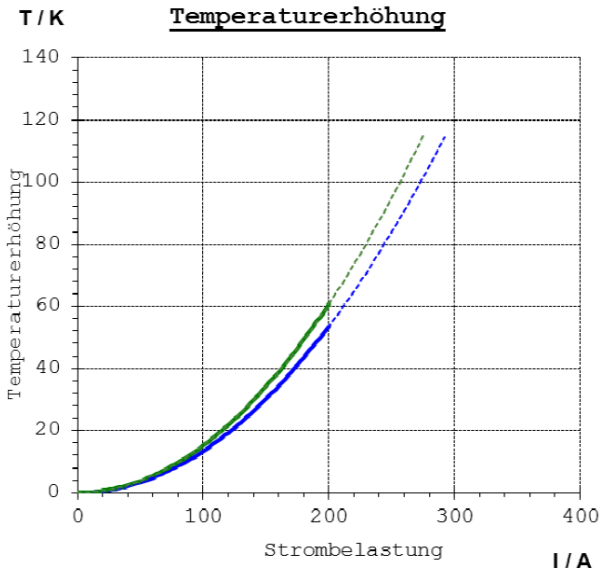

Figure 3: 50mm² (Coroplast-No. 9-2611) Derating and temperature rise – Current at shield
Abbildung 3: 50mm² (Coroplast-No. 9-2611) Derating und Stromerwaermung - Schirmung

5.2 Housing influence on derating: 3pos. Connector

Gehäuseeinfluss auf Derating: 3pol. Steckverbinde

Derating inside housing: Current at contact with load at shield

Derating im Gehäuse: Kontaktbestromung mit Schirmbelastung

Cable length according to DIN EN 60512-5-2

Leitungslaenge nach DIN EN 60512-5-2

Test setup

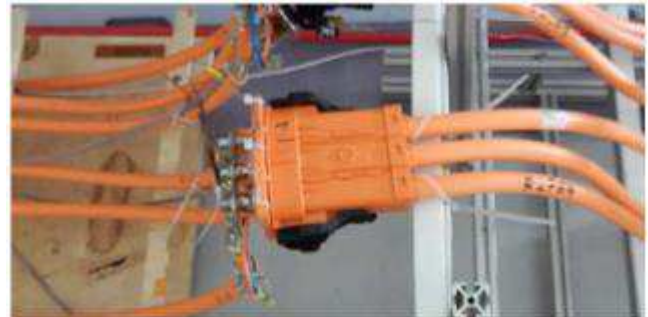
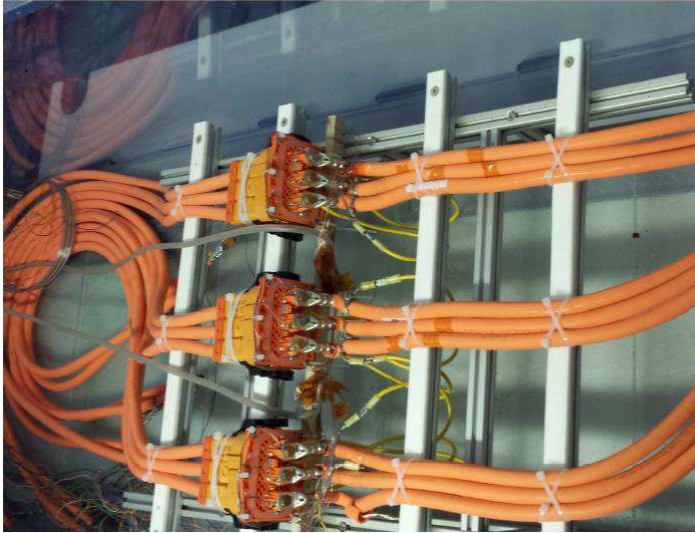

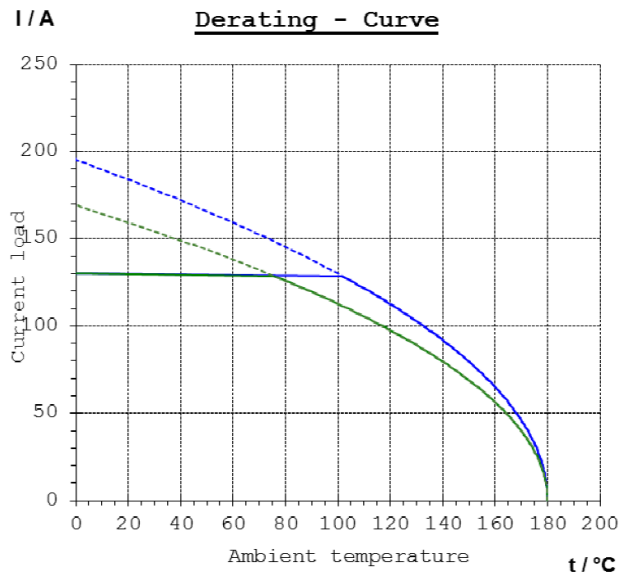
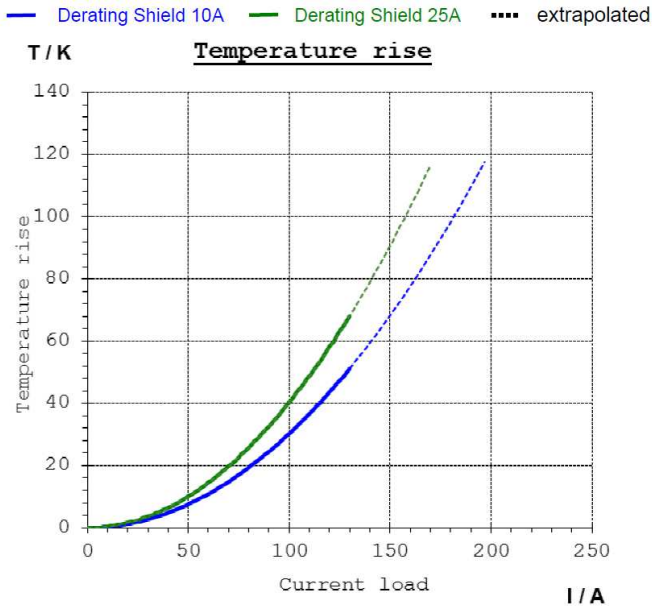

Figure 4: 25 mm² (Coroplast-No. 9-2611) Derating and temperature rise – Current at shield
Abbildung 4: 25 mm² (Coroplast-No. 9-2611) Derating und Stromerwaermung - Schirmung

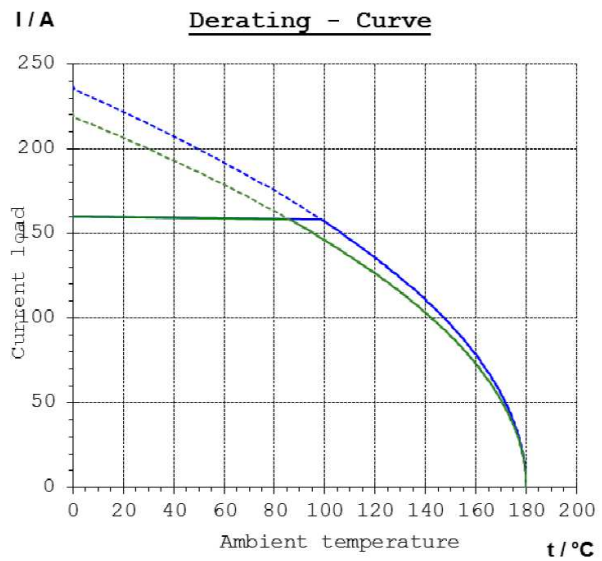
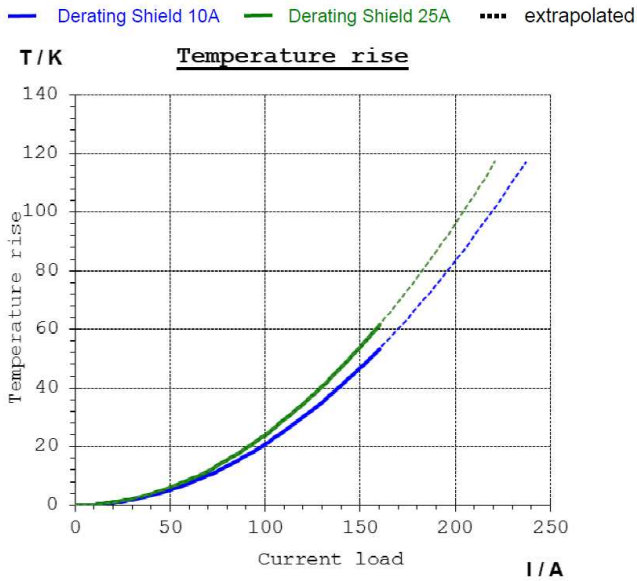

Figure 5: 35 mm² (Coroplast-No. 9-2611) Derating and temperature rise – Current at shield
Abbildung 5: 35 mm² (Coroplast-No. 9-2611) Derating und Stromerwaermung – Schirmung

— Load on 3 samples — Load only on middle sample

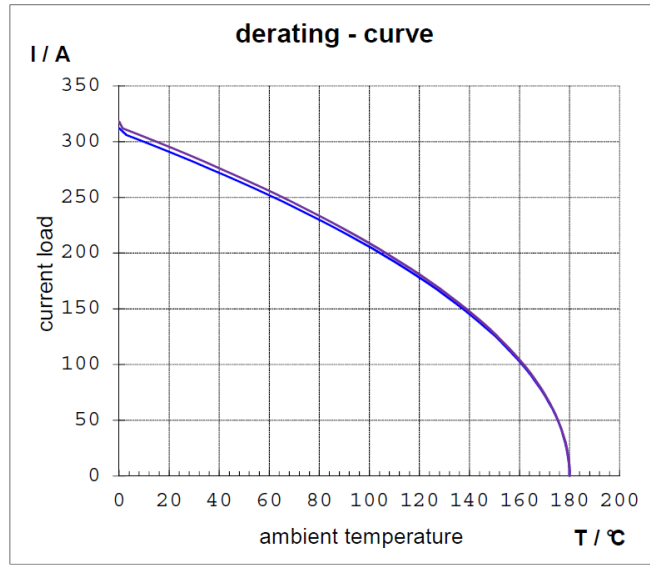
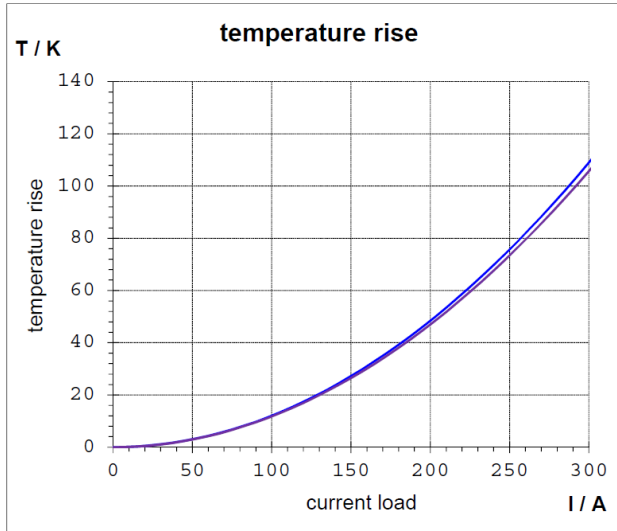

Figure 6: 50mm² (Coroplast-No. 9-2611) Derating and temperature rise – Current at shield
Abbildung 6: 50mm² (Coroplast-No. 9-2611) Derating und Stromerwaermung – Schirmung

— Contact (Average across all samples)

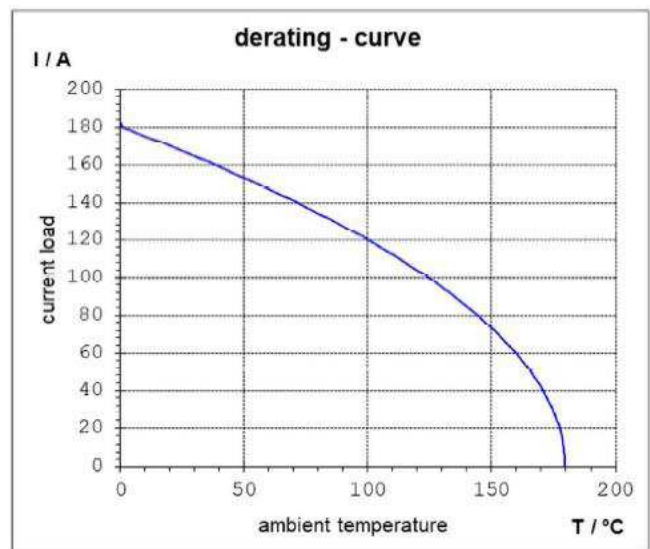
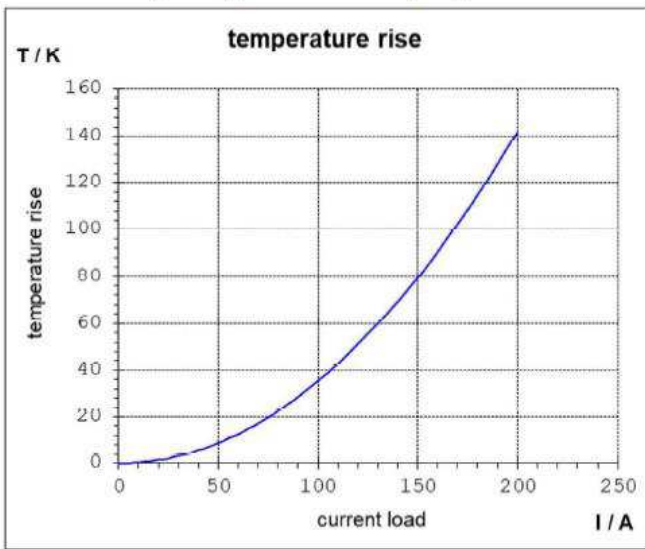

Figure 7: 16mm² (Coficab Silicon-No. FHLR2GCB2G) Derating and temperature rise – Current at contact
Abbildung 7: 16mm² (Coficab Silicon-No. FHLR2GCB2G) Derating und Stromerwaermung – Strom bei Kontakt

— Contact (Average of all terminals)

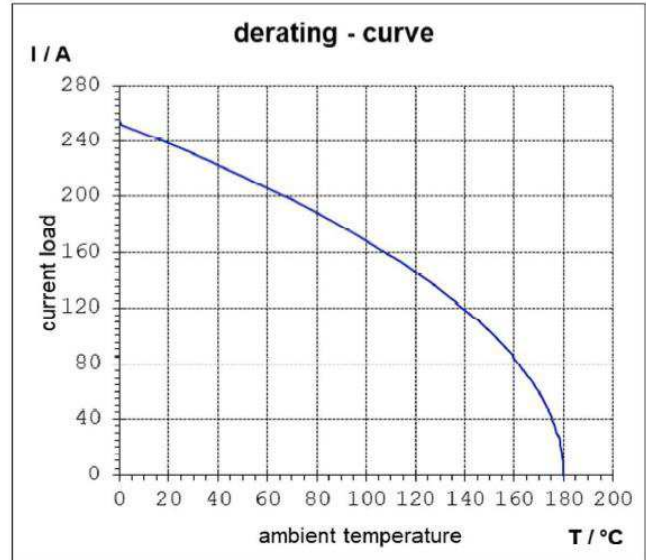
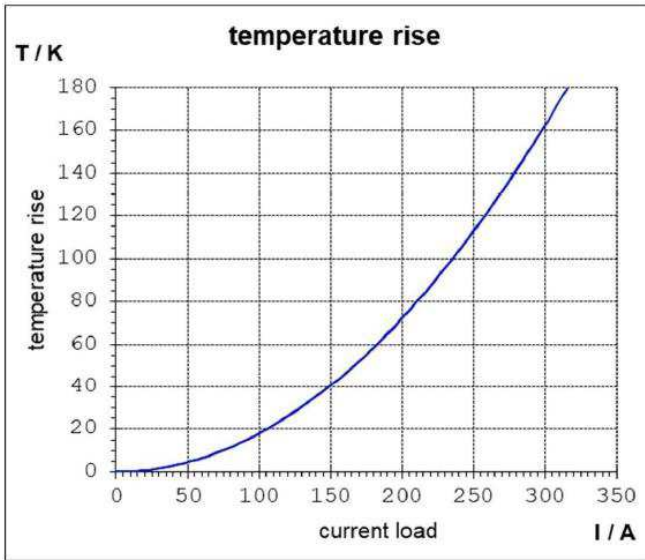

Figure 8: 25mm² (Coficab Silicon-No. FHLR2GCB2G/LGCBG025HHH) Derating and temperature rise – Current at contact

Abbildung 8: 25mm² (Coficab Silicon-No. FHLR2GCB2G/LGCBG025HHH) Derating und Stromerwaermung – Strom bei Kontakt

— Contact (Average across all samples)

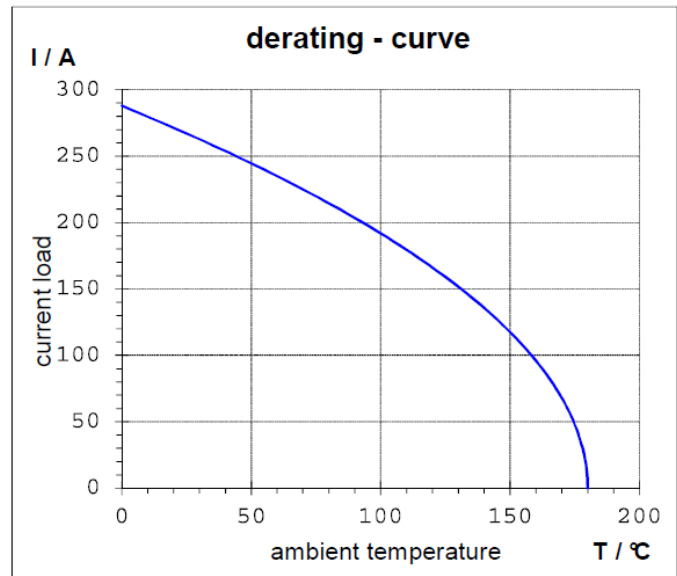
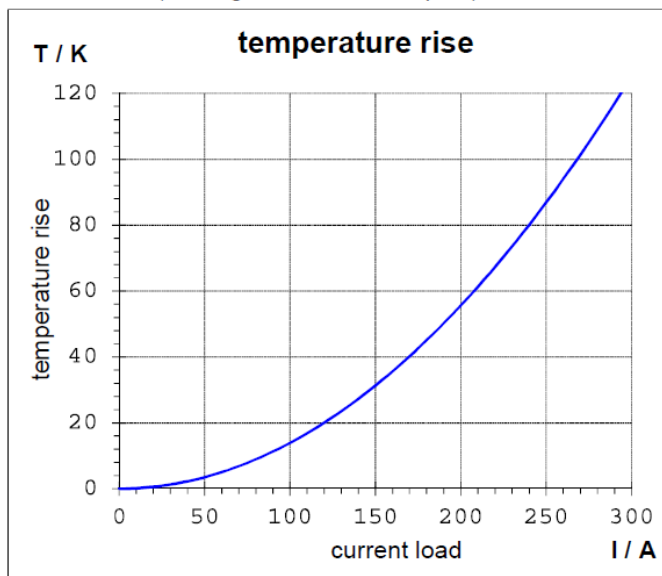

Figure 9: 35mm² (Coficab Silicon-No. FHLR2GCB2G/LGCBG025HHH) Derating and temperature rise – Current at contact

Abbildung 9: 35mm² (Coficab Silicon-No. FHLR2GCB2G/LGCBG025HHH) Derating und Stromerwaermung – Strom bei Kontakt

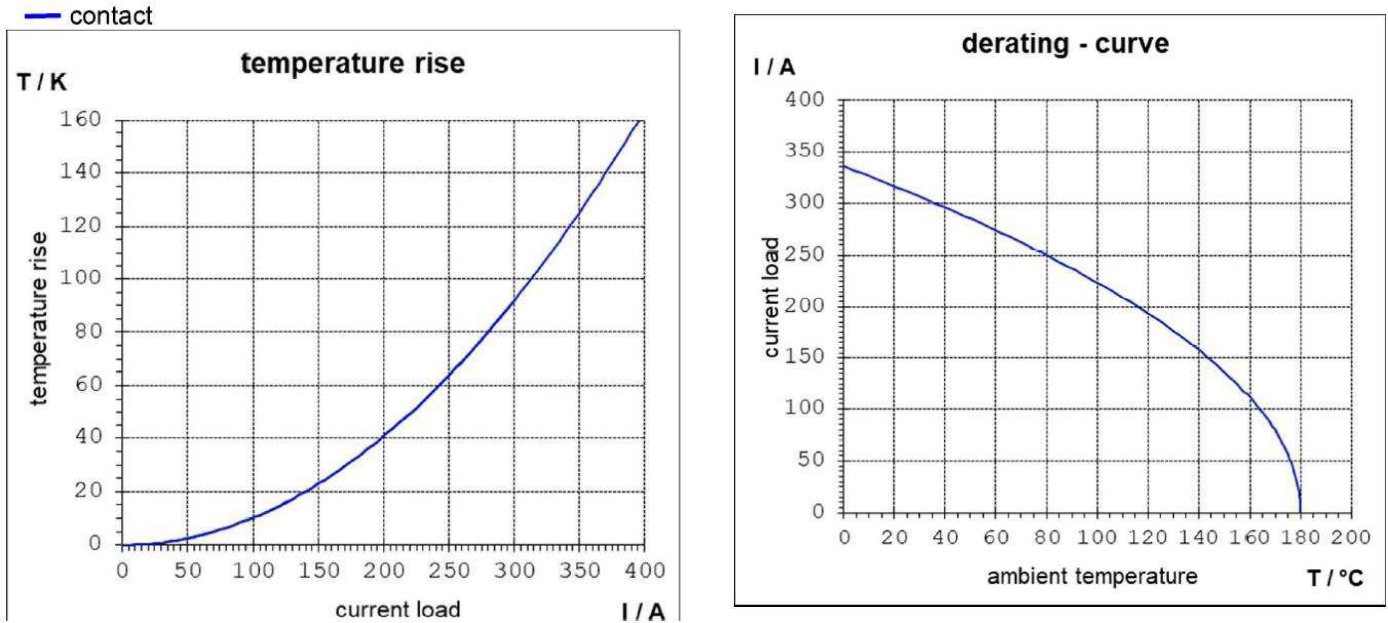

Figure 10: 50mm² (Coficab Silicon-No. FHLR2GCB2G/LGCBG025HHH) Derating and temperature rise – Current at Shield
Abbildung 10: 50mm² (Coficab Silicon-No. FHLR2GCB2G/LGCBG025HHH) Derating und Stromerwaermung – Schirmung

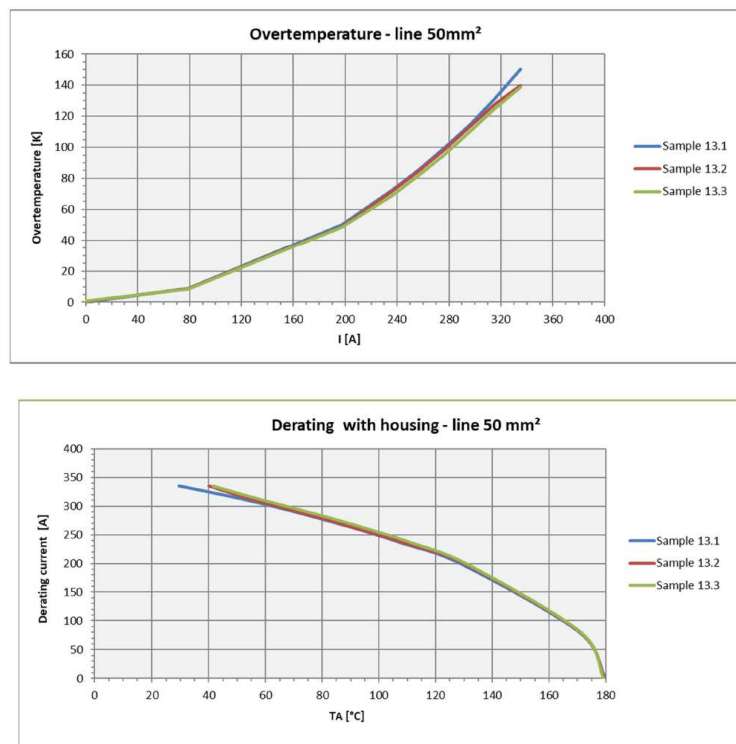
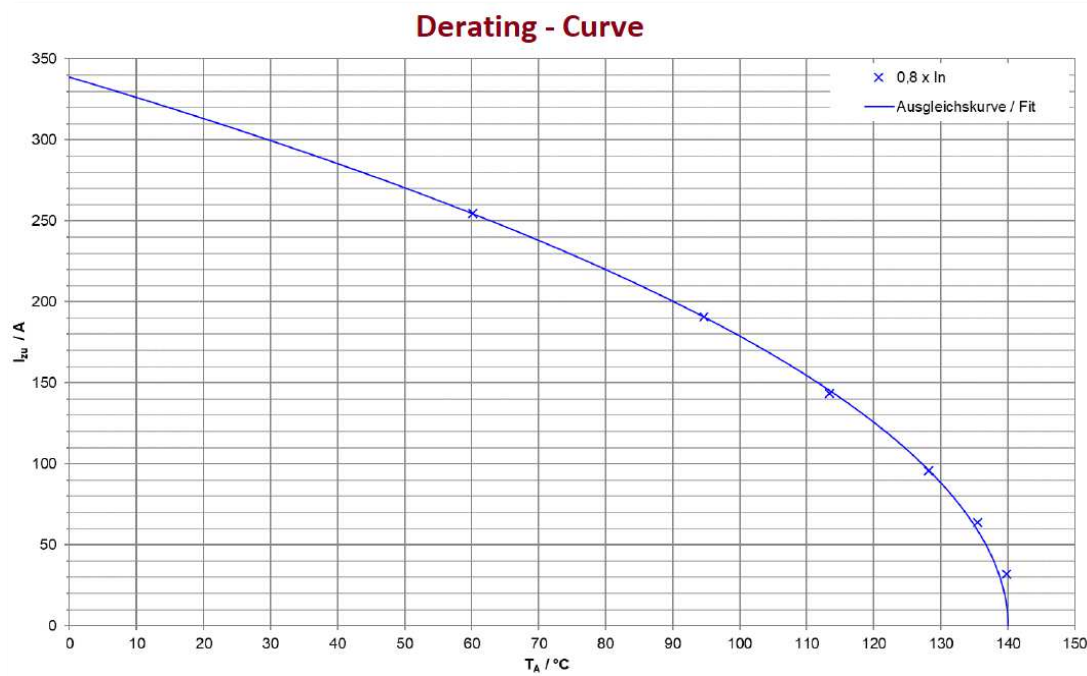
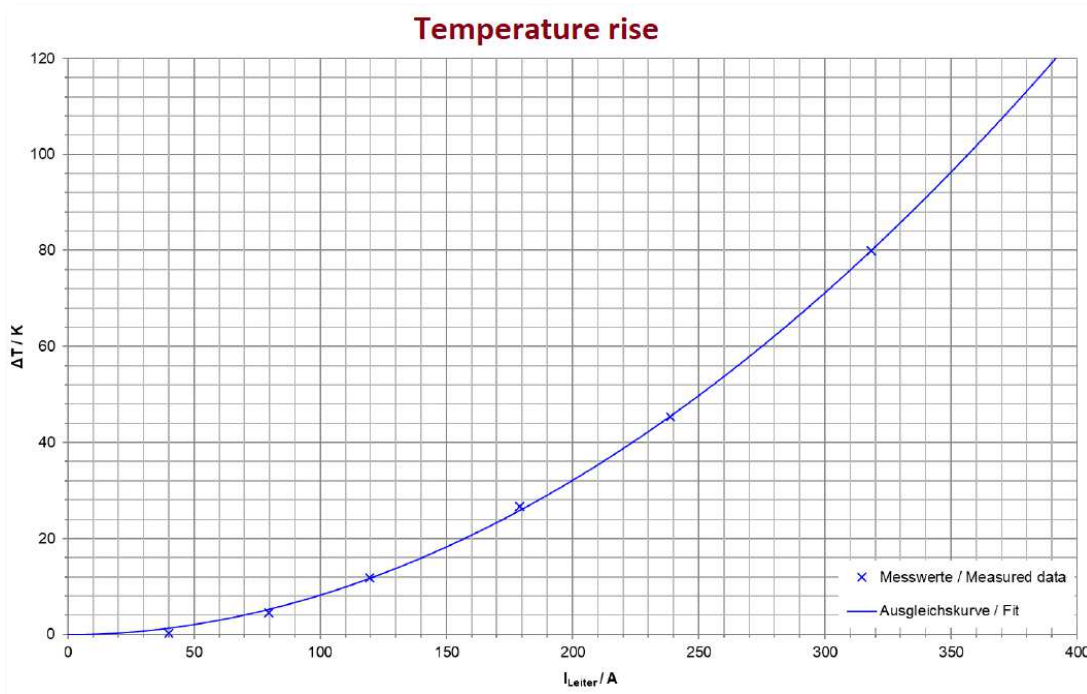

Figure 11: 50mm² (Coficab XPO-No. HL3XCBX50HHH temperature, limit is 125°C) Derating and temperature rise – Current at Shield
Abbildung 11: 50mm² (Coficab XPO-No. HL3XCBX50HHH, Temperaturgrenze liegt bei 125°C) Derating und Stromerwaermung – Schirmung

Figure 12: 50mm² (HUBER+SUHNER. No. FHLR4GC13X) Derating and temperature rise – Current at Shield **
Abbildung 12: 50mm² (HUBER+SUHNER. No. FHLR4GC13X) Derating und Stromerwaermung – Schirmung



**** Not recommended for automotive use**

Figure 13: 50mm² (HUBER+SUHNER. No. FHLR4GC13X) Derating and temperature rise –10A Current at Shield **

Abbildung 13: 50mm² (HUBER+SUHNER. No. FHLR4GC13X) Derating und Stromerwaerung – 10A Schirmunstrom

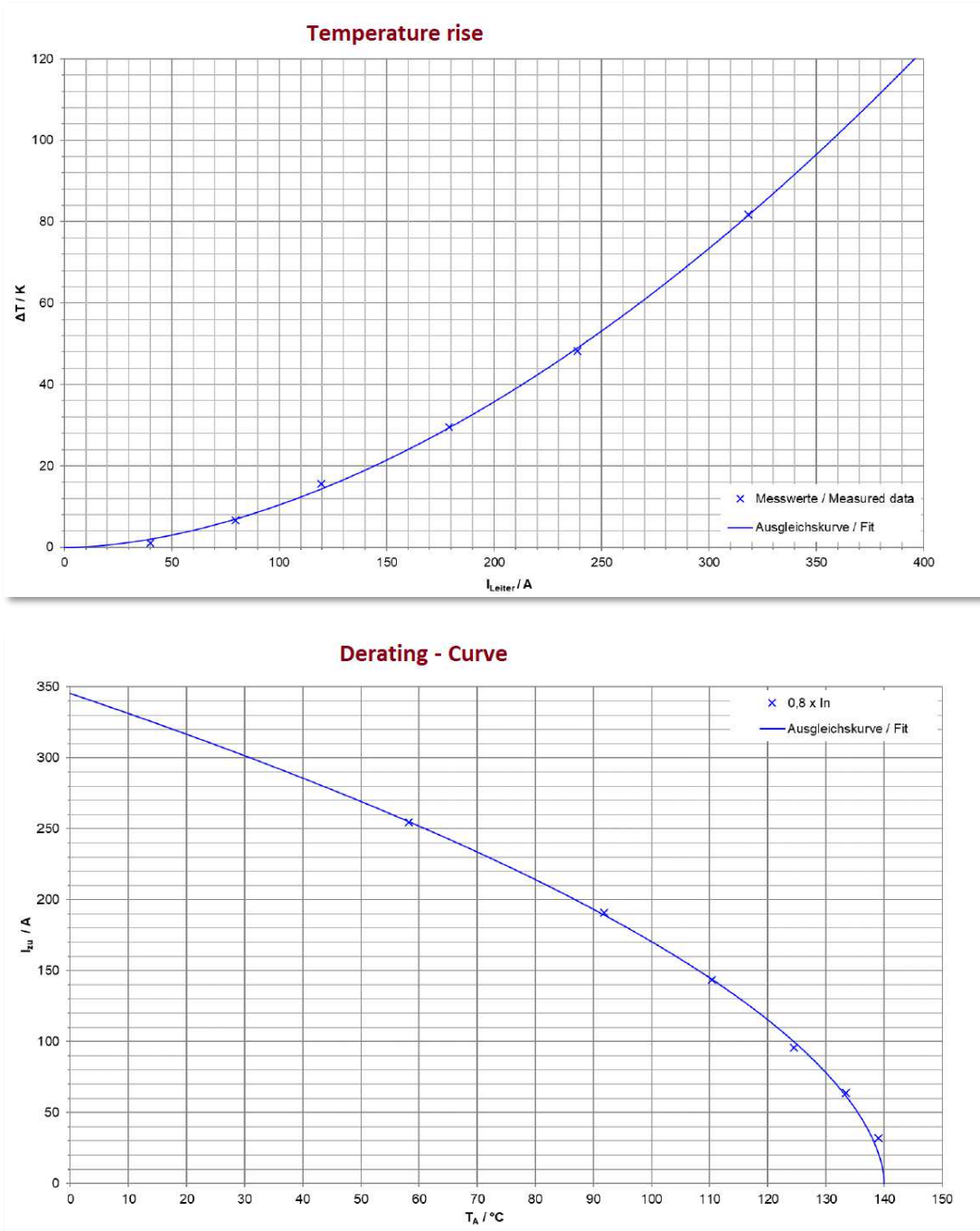

**** Not recommended for automotive use**

5.3 Dynamic load

Dynamische Beanspruchung

Dynamic load acc. LV214 (release 03.2010)

Dynamische Beanspruchung gemaess LV 214 (Ausgabe 03.2010)

Design of vibration device (see picture 7)

Aufbau der Vibrationsvorrichtung (siehe Bild 7)

2 and 3pos. connector

2 und 3pol- Steckverbinder

Coroplast 50mm² acc. to Coroplast-No.: 9-2611 / 50mm², Version A4

Coroplast 50mm² nach Datenblatt-Nr.: 9-2611 / 50mm², Revision A4

Cable fixed after Dimensioning

A= 100mm

Leitungsabfangung nach Mass

A= 100mm

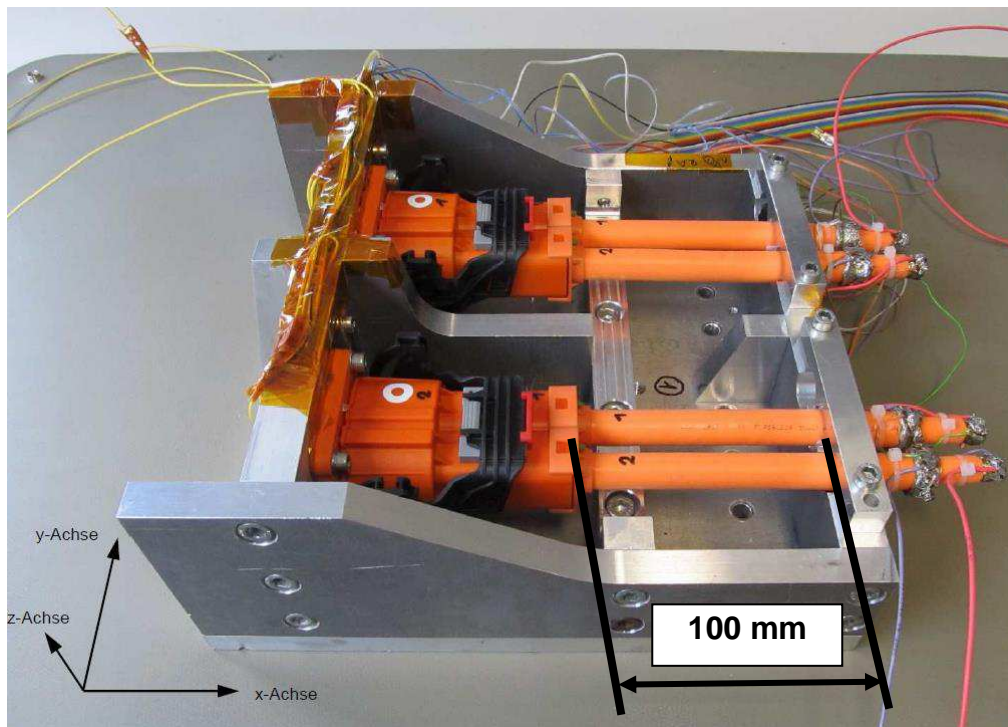

Figure 14: Vibration device (exemplary view at 2pos. connector)

Abbildung 14: Vibrationsvorrichtung (exemplarische Darstellung mit 2 pol. Stecker)

5.4 Contact engagement length

Kontaktueberdeckung

- A **Contact overlap – power contact** $\geq 1mm$
Kontaktueberdeckung – Leistungskontakt
- B **Contact overlap – HVIL contact** $\geq 1mm$
Kontaktueberdeckung – HVIL Kontakt
- C **Interlock Disconnected advanced by pull-out process** $\geq 1mm$
Voreilende Trennung des HVIL beim Ziehvorgang

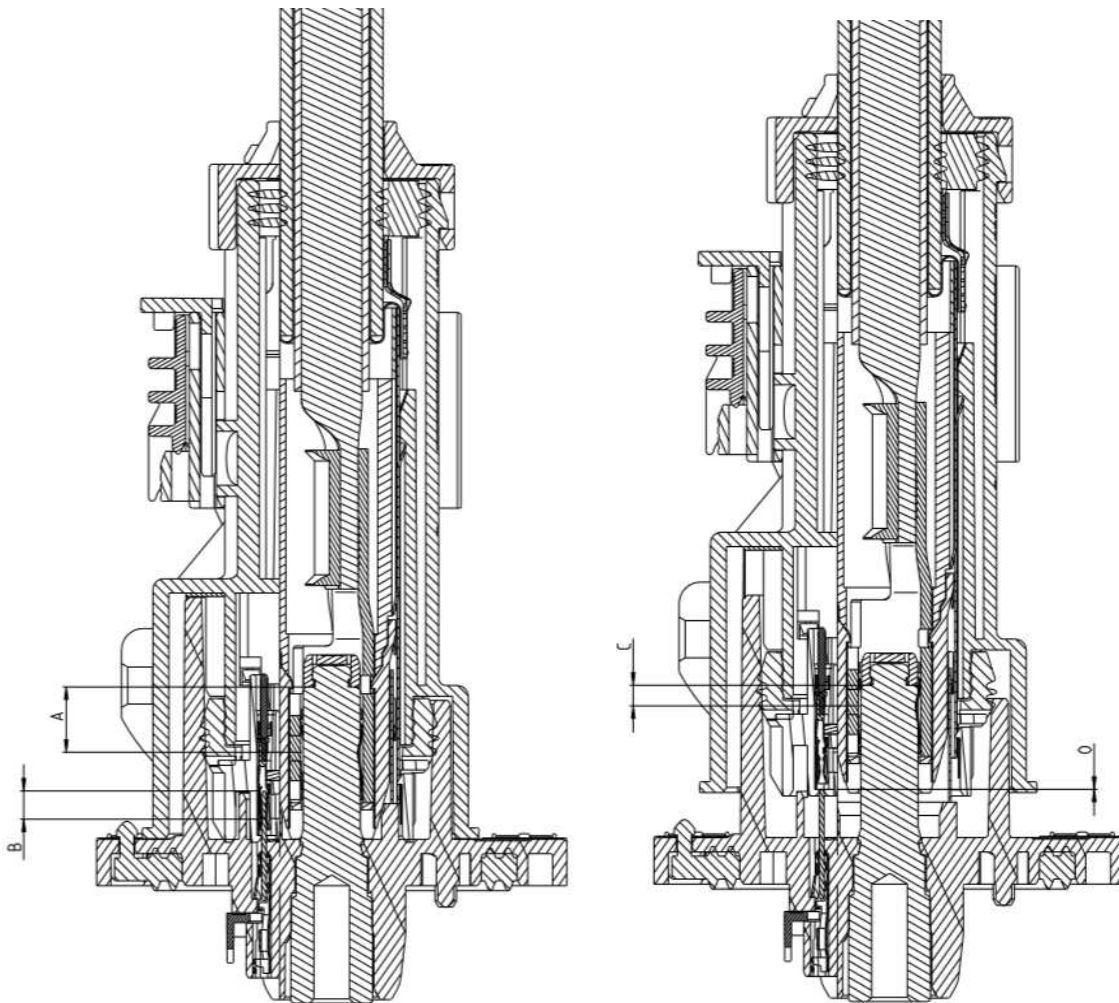

Figure 15: Contact engagement length

Abbildung 15: Kontaktueberdeckung

5.5 Strain Relief

Leitungsabfangung

System is validated with strain relief at 100mm. Each application has to be evaluated independently with regards to the external influences on the system. Having strain relief, which moves with the connector body, close to the end of the connector will have a positive influence on the performance of the connector. Having strain relief further from the end of the connector or that moves independent of the connector body will have a negative influence on the performance of the connectors.

Die Steckverbindung wurde mit einer Leitungsabfangung von 100mm validiert. Jede Applikation ist aufgrund ihrer individuellen Anforderungen gesondert zu beurteilen. Leitungsabfangungen nach groesseren Laengen als 100mm haben eine negative Auswirkung auf die Steckerverbinder-Performance und entsprechend positive bei kuerzeren Distanzen

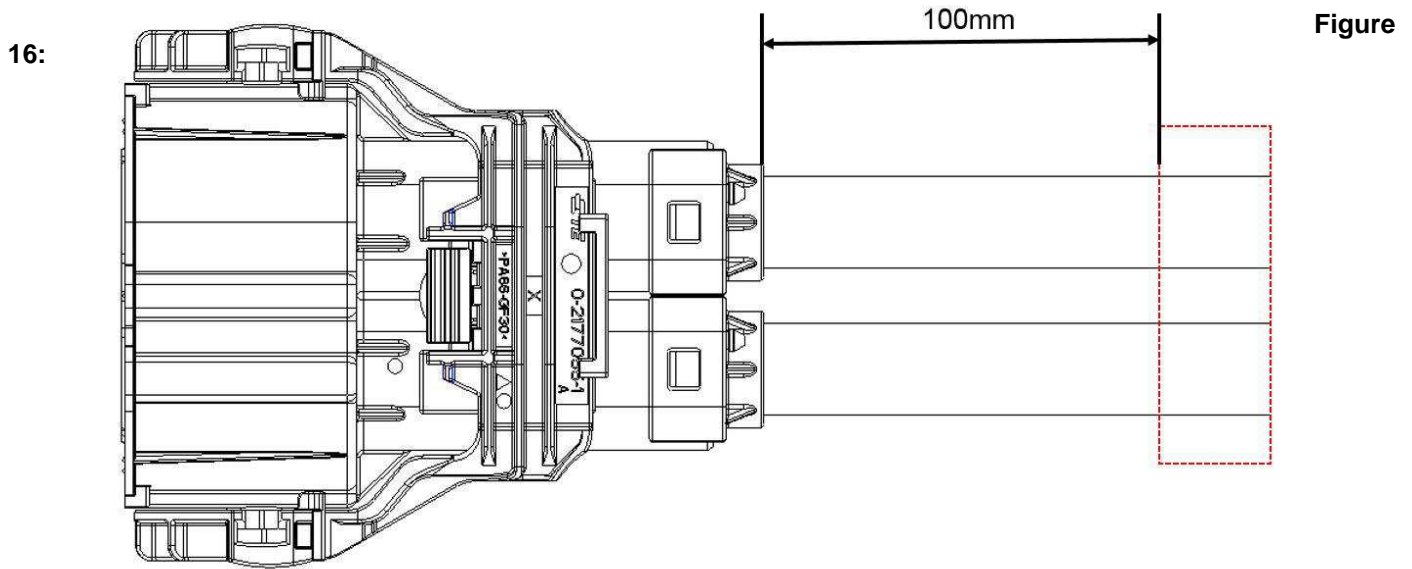

Recommended requirement for strain relief

Abbildung 16: Empfohlene Anforderungen Leitungsabfangung

<u>LTR</u>	<u>REVISION RECORD</u>	<u>DWN</u>	<u>APP</u>	<u>DATE</u>
E3	Updated Table 2: Alternative shield BN 2413297 is added Update for H+S cable with (**) Symbol	JAGADEESH J	MILOSLAV H	16JAN2025
E2	Added temperature limit related note with (*) symbol	JAGADEESH J	MILOSLAV H	01AUG2023
E1	Updated Table 8: References/Referenzen With H+S Cable details	JAGADEESH J	MILOSLAV H	10DEC2021
E	Added H+S, Coficab – silicone and XPO Cable details	JAGADEESH J	MILOSLAV H	25NOV2021
D2	Max. and Dielectric voltage modified	SHASHIKUMAR	TOMAS S	01JUN2021
D1	Document rev with proper date updated	SHASHIKUMAR	TOMAS S	24DEC2020
D	Replacing Turned Recp. Contact to Stamped	SHASHIKUMAR	TOMAS S	13JAN2020
C	V0 Header updates	SHASHIKUMAR	TOMAS S	15MAY2019