



NOTE

All numerical values are in metric units [with U.S. customary units in brackets]. Dimensions are in millimeters [and inches]. Unless otherwise specified, dimensions have a tolerance of ± 0.13 [$\pm .005$] and angles have a tolerance of $\pm 2^\circ$. Figures and illustrations are for identification only and are not drawn to scale.

1. INTRODUCTION

This specification covers the requirements for application of .058 and .093 diameter pc board pins and disconnect receptacle contacts. The pins are available in solid or formed press-fit and clinch fit. The pins feature a pin body, bead, and cutoff tab. The bead ensures proper insertion depth of the pin when inserted into the pc board. The clinch fit pin has legs that clinch the pc board for stability. The receptacle contact features a wire barrel with serrations, insulation barrel, and mating barrel. The pin must be soldered to the pc board and the receptacle contact must be crimped onto wire. The pin and receptacle contact mates for quick disconnect of single-circuit wire-to-board connections.

The pins and receptacle contacts are available in loose pieces for application using hand tools and strip form for application using semi-automatic and automatic machines.

When corresponding with personnel, use the terminology provided in this specification to facilitate inquiries for information. Basic terms and features of this product are provided in Figure 1.

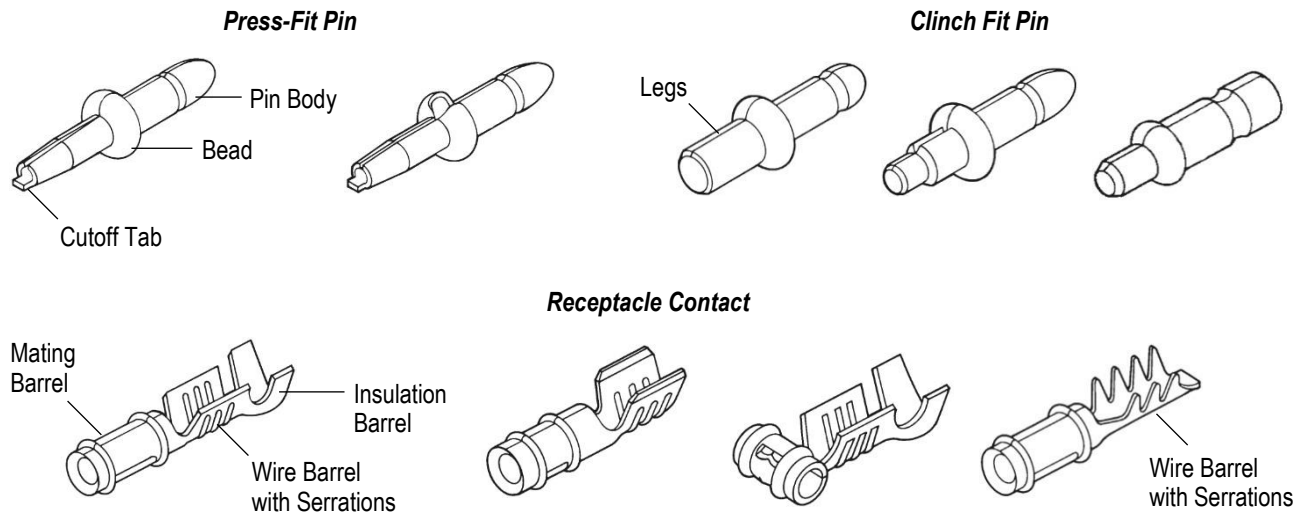

Figure 1

2. REFERENCE MATERIAL

2.1. Revision Summary

Revisions to this application specification include:

- Updated requirements for wire barrel seam with hand tool in Paragraph 3.7.E
- Modified tooling in Section 5
- Removed obsoleted Hand Crimping Tools and added Ocean Applicators in Section 2.5

2.2. Customer Assistance

Reference Product Base Part Number 61137 and Product Code 1330 are representative of .058 and .093 diameter pc board pins and disconnect receptacle contacts. Use of these numbers will identify the product line and help you to obtain product and tooling information. Such information can be obtained through a local Representative, by visiting our website at www.te.com, or by calling PRODUCT INFORMATION or the TOOLING ASSISTANCE CENTER at the numbers at the bottom of this page.

2.3. Drawings

Customer Drawings for product part numbers are available from the service network. If there is a conflict between the information contained in the Customer Drawings and this specification or with any other technical documentation supplied, the information contained in the Customer Drawings takes priority.

2.4. Specifications

Product specifications (108-series) provides product performance and test results. Specifications available for this product are:

- 108-1025 .058 Diameter PC Board Disconnect System
- 108-1059 .093 Diameter PC Board Disconnect System

2.5. Instructional Material

Instruction sheets (408-series) provide product assembly instructions or tool setup and operation procedures. Instruction sheets available that pertain to this product are:

- 408-35042 Ocean 2.0 Side-Feed Applicators
- 408-35043 Ocean 2.0 End-Feed Applicators
- 408-8547 Hand Crimping Tool 2063857-1
- 408-8547 Hand Crimping Tool 2305781-1
- 408-8547 Hand Crimping Tool 91507-1
- 408-8025 Miniature Quick-Change Applicator (Side Feed Type)
- 408-8039 Heavy Duty Miniature Quick-Change Applicators (End-Feed Type) with Mechanical or Air Feed Systems
- 408-8040 Heavy Duty Miniature Quick-Change Applicators (Side-Feed Type) with Mechanical or Air Feed Systems
- 409-10047 AMP 3K* Terminating Machines 1725950-[] and AMP 5K* Terminating Machines 1725900-[]
- 409-10089 AccuSserter 2 Insertion Machines 1976500-[]
- 409-10093 Pin-Barrel Insertion Module 2031100-1
- 409-10204 AMP 3K/40* 2161400-[] CE Terminating Machines and AMP 5K/40* 216500-[] CE Terminating Machines

3. REQUIREMENTS

3.1. Safety

Do not stack product shipping containers so high that the containers buckle or deform.

3.2. Storage

A. Ultraviolet Light

Prolonged exposure to ultraviolet light may deteriorate the chemical composition used in the product material.

B. Shelf Life

The product should remain in the shipping containers until ready for use to prevent deformation to components. The product should be used on a first in, first out basis to avoid storage contamination that could adversely affect performance.

C. Chemical Exposure

Do not store product near any chemical listed below as they may cause stress corrosion cracking in the material.

Alkalies	Ammonia	Citrates	Phosphates	Citrates	Sulfur Compounds
Amines	Carbonates	Nitrites	Sulfur Nitrites		Tartrates

3.3. PC Board

The pc board thickness and placement of the holes must meet the dimensions given in Figure 2.

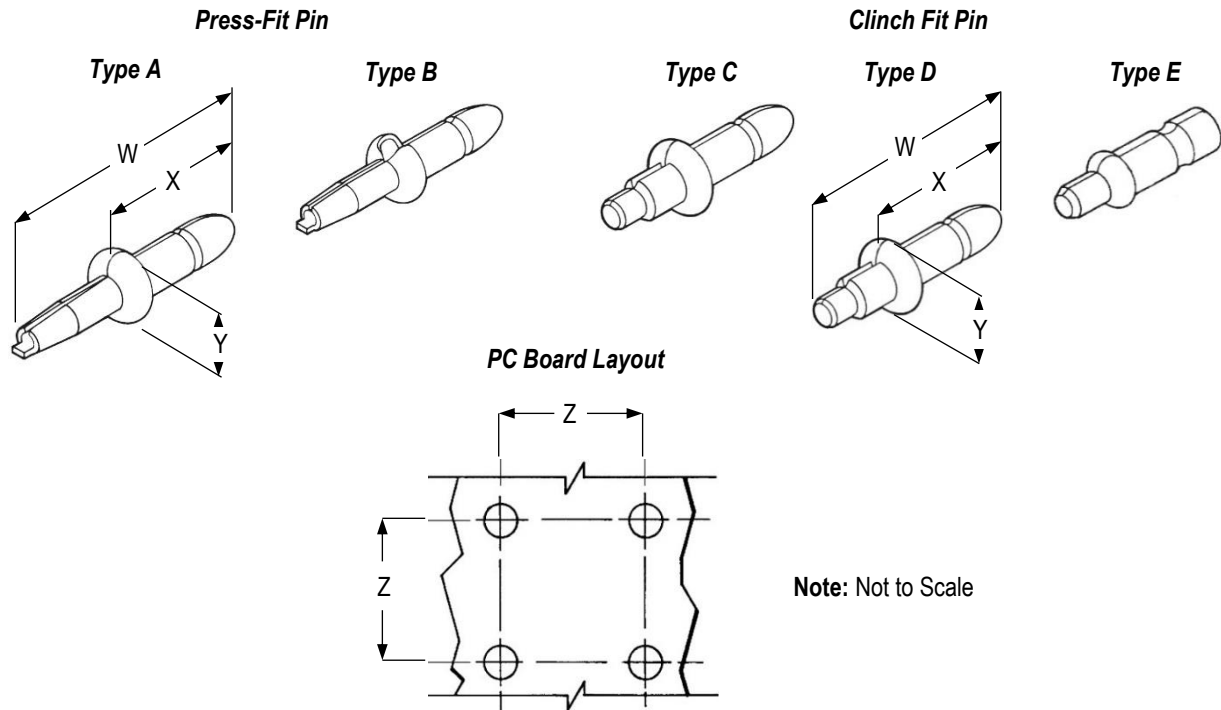

DESCRIPTION	DIAMETER	PIN				PC BOARD		
		TYPE	DIMENSION			THICKNESS	HOLE DIAMETER	DIMENSION Z
			W	X	Y			
Press Fit	.058	A	9.14 [.360]	5.33 [.210]	2.41 [.095]	1.588 [.0625] or 2.380 [.0937]	1.17-1.27 [.046-.050]	3.18 [.125] Min
			12.32 [.485]				1.47-1.57 [.058-.062]	
			9.14 [.360]	1.68-1.78 [.066-.070]				
		B	9.14 [.360]	5.33 [.210]	2.41 [.095]	1.588 [.0625] or 2.380 [.0937]	1.17-1.27 [.046-.050]	
Clinch Fit	.058	C	7.87 [.310]	5.33 [.210]	2.41 [.095]	1.588 [.0625]	1.40-1.55 [.055-.061]	4.44 [.175]
							1.70-1.85 [.067-.073]	
		D	7.87 [.310]	5.33 [.210]	2.41 [.095]	1.588 [.0625]	1.17-1.27 [.046-.050]	4.44 [.175]
	1.19 [.047]						1.40-1.55 [.055-.061]	5.08 [.200]
	.093	E	10.41 [.410]	7.75 [.305]	2.92 [.115]	1.588 [.0625]	1.70-1.85 [.067-.073]	4.44 [.175]

Figure 2

3.4. Soldering

A. Guidelines

The pins can be soldered using wave soldering techniques. The temperatures and exposure time must be within the ranges specified in Figure 3.

SOLDERING PROCESS	TEMPERATURE	TIME (At Max Temperature)
Wave	260°C [500°F]	5 Seconds

Figure 3

B. Flux Selection

Pins must be fluxed prior to soldering with a mildly-active, rosin base flux. Selection of the flux will depend on the type of pc board and other components mounted on the board. Additionally, the flux must be compatible with the wave solder line, manufacturing, health, and safety requirements. Fluxes that are compatible with these pins are provided in Figure 4.

TYPE	ACTIVITY	RESIDUE	COMMERCIAL DESIGNATION	
			ALPHA	KESTER
RMA	Mild	Noncorrosive	611	186

Figure 4

C. Cleaning

After soldering, removal of fluxes, residues, and activators is necessary. Consult with the supplier of the solder and flux for recommended cleaning solvents. Common cleaning solvents with times and temperatures that will not affect these pins are specified in Figure 5.

CLEANER		TIME (Minutes)	TEMPERATURE (Max)
NAME	TYPE		
ALPHA 2110	Aqueous	1	132°C [270°F]
BIOACT EC-7	Solvent	5	100°C [212°F]
Butyl CARBITOL	Solvent	1	Ambient Room
Isopropyl Alcohol	Solvent	5	100°C [212°F]
KESTER 5778	Aqueous		
KESTER 5779	Aqueous		
LONCOTERGE 520	Aqueous		
LONCOTERGE 530	Aqueous		
Terpene	Solvent		

Figure 5



NOTE

If a particular cleaning solvent is not listed, contact PRODUCT INFORMATION at the number at the bottom of page 1 for advice.



DANGER

Consideration must be given to toxicity and other safety requirements recommended by the solvent manufacturer. Refer to the manufacturer's material safety data sheet (MSDS) for characteristics and handling of cleaners. Trichloroethylene and methylene chloride is not recommended because of harmful occupational and environmental effects. Both are carcinogenic (cancer-causing).

D. Drying

When drying cleaned assemblies and pc boards, make certain that temperature limitations are not exceeded: -55 to 105°C [-67 to 221°F] for standard temperature products. Excessive temperatures may cause pin degradation.

3.5. Pin Insertion

A. Carrier Cutoff Tab

The pin cutoff tab must not exceed the dimension given in Figure 7.

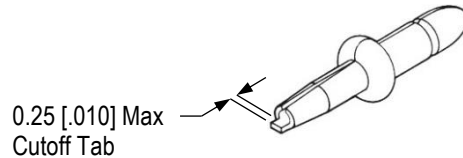
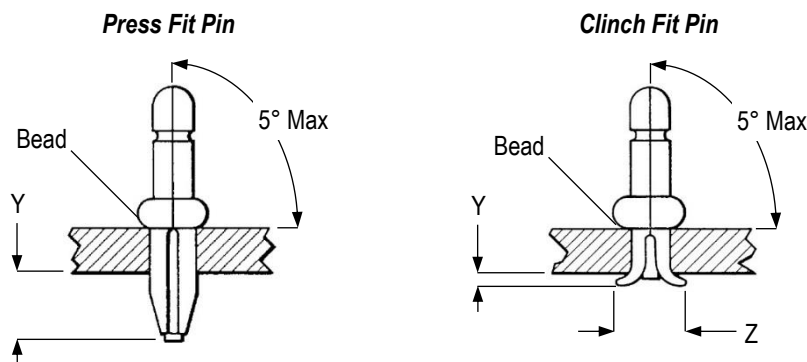

Figure 6

B. Inspection

- Leg protrusion (including the cutoff tab) must meet dimension given in Figure 7.
For the clinch fit pin, the width of the legs must meet dimension given in Figure 7.
- The bead of the pin must be in contact with the pc board.
- The pin must be perpendicular to the pc board to a maximum of 5 degrees.
- The pin must not be able to rotate, nor exhibit looseness, when torque is applied by finger force.



PIN			PC BOARD THICKNESS	DIMENSION	
DESCRIPTION	DIAMETER	TYPE		Y	Z
Press Fit	.058	A, B	1.588 [.0625]	1.65-2.79 [.065-.110]	—
			2.380 [.0937]	1.65-2.16 [.065-.085]	—
Clinch Fit	.058	C	1.588 [.0625]	0.38-1.42 [.015-.056]	2.79±0.51 [.110±.020]
		D	1.588 [.0625]	1.27 [.050] Max	2.92 [.115] Max
	1.19 [.047]		1.14 [.045] Max	3.55 [.140] Max	
	.093	E	1.588 [.0625]	0.38-1.42 [.015-.056]	2.79±0.51 [.110±.020]

Figure 7

- The inserted pin must have solder fillets evenly formed around each leg.

3.6. Wire Selection and Preparation

The receptacle contacts accept a stranded wire size range of 28 to 17 AWG and tinsel wire with an insulation diameter between 0.81 and 2.79 [.032 and .110].

The wire strip length must be between 3.56 and 3.94 [.140 and .155]. Reasonable care must be taken during the stripping operation to ensure the wire is not nicked, scraped, or cut.

3.7. Crimp Requirements

The receptacle contact must be crimped to the wire according to instructions packaged with applicable tooling.

A. Cutoff Tab and Burr

The cutoff tab and burr must not exceed the dimension given in Figure 8.

B. Wire Barrel and Insulation Barrel Crimp

The wire barrel flash, wire barrel crimp height (not including flash) and width, and insulation barrel crimp height and width must not exceed the dimensions given in Figure 8.

C. Wire Conductors and Insulation Location

The wire insulation must not enter the wire barrel. Both the wire conductors and insulation must be visible between the insulation barrel and wire barrel. The end of the wire conductors must be flush with or extend no further than the front of the wire barrel to meet the dimension given in Figure 8.

D. Bellmouths

The front and rear bellmouths must not exceed the dimensions given in Figure 8.

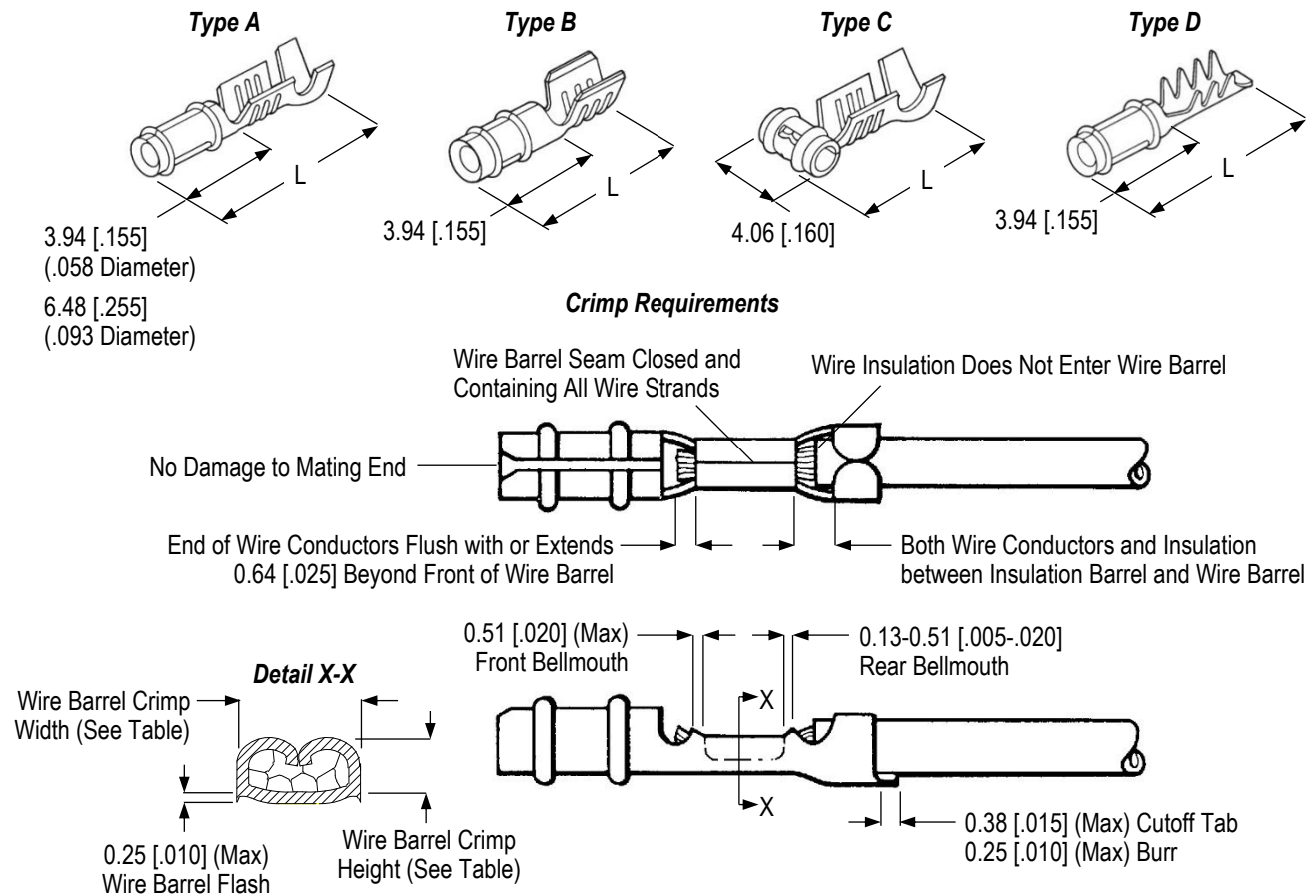

Figure 8 (Cont'd)

USING HAND TOOL

WIRE		RECEPTACLE CONTACT					
SIZE (AWG)	INSULATON DIAMETER	DIAMETER	TYPE	DIMENSION L	WIRE BARREL CRIMP		INSULATION BARREL CRIMP WIDTH
					HEIGHT ± 0.05 [$\pm .002$]	WIDTH	
28-26	0.89-1.14 [.035-.045]	.058	A, C	9.65 [.380]	0.61 [.024]	1.40 [.055]	1.57 [.062]
26-22	0.89-1.65 [.035-.045]				0.66 [.026]		
24-20	1.14-1.78 [.045-.070]			9.65 [.380]	0.84 [.033]	1.40 [.055]	2.03 [.080]
24-22	1.52-2.29 [.060-.090]	.058	A	10.03 [.395]	0.81 [.032]	1.40 [.055]	2.29 [.090]
22-18	1.02-2.54 [.040-.100]	.093		13.97 [.550]	0.84 [.033]		2.79 [.110]
22-20	1.52-2.29 [.060-.090]	.058	B	7.62 [.300]	0.94 [.037]	1.78 [.070]	2.29 [.090]
18-17					1.24 [.049]		
24-20	1.02-2.54 [.040-.100]	.058	C	8.51 [.335]	0.84 [.033]	1.40 [.055]	2.79 [.110]

USING APPLICATOR

WIRE		RECEPTACLE CONTACT					
SIZE (AWG)	INSULATON DIAMETER	DIAMETER	TYPE	DIMENSION L	WIRE BARREL CRIMP		INSULATION BARREL CRIMP WIDTH
					HEIGHT ± 0.05 [$\pm .002$]	WIDTH	
28	0.89-1.14 [.035-.045]	.058	A	9.65 [.380]	0.63 [.025]	1.40 [.055]	1.78 [.070]
26					0.68 [.027]		
26					0.66 [.026]		
24	0.89-1.65 [.035-.065]	.058	A	9.65 [.380]	0.74 [.029]	1.40 [.055]	2.03 [.080]
22					0.81 [.032]		
26	0.89-1.65 [.035-.065]	.058	A	10.03 [.395]	0.99 [.039]	1.40 [.055]	2.03 [.080]
24					1.02 [.040]		
22					1.12 [.044]		
24	1.14-1.78 [.045-.070]	.058	A	9.65 [.380]	0.86 [.034]	1.40 [.055]	2.29 [.090]
22					0.94 [.037]		
20					1.04 [.041]		
24	1.52-2.29 [.060-.090]	.058	A	10.03 [.395]	0.86 [.034]	1.40 [.055]	2.29 [.090]
22					0.94 [.037]		
20					1.04 [.041]		
22	2.79 [.110] Max	.058	A	10.03 [.395]	0.94 [.037]	1.78 [.070]	2.29 [.090]
20					1.02 [.040]		
18					1.14 [.045]		
26	1.02-2.79 [.040-.110]	.058	A	10.03 [.395]	0.81 [.032]	1.40 [.055]	3.05 [.120]
24					0.86 [.034]		
22					0.94 [.037]		
20					1.04 [.041]		
28	0.81-1.45 [.032-.057]	.093	A	13.84 [.545]	0.74 [.029]	1.40 [.055]	2.29 [.090]
26							

22	1.52-2.79 [.060-.110]	.093	A	13.97 [.550]	1.09 [.043]	1.78 [.070]	3.05 [.120]
20					1.17 [.046]		
18					1.29 [.051]		
22	1.52-2.79 [.060-.110]	.058	B	7.62 [.300]	1.02 [.040]	1.78 [.070]	2.29 [.090]
20					1.09 [.043]		
18					1.22 [.048]		
17					1.32 [.052]		
22	1.02-2.79 [.040-.110]	.093	B	10.03 [.395]	1.09 [.043]	1.78 [.070]	3.05 [.120]
20					1.17 [.046]		
18					1.30 [.051]		
26	0.89-1.65 [.035-.065]	.058	C	8.38 [.330]	0.71 [.028]	1.40 [.055]	1.78 [.070]
24					0.74 [.029]		
22					0.84 [.033]		
24	1.14-1.78 [.045-.070]	.058	C	8.38 [.330]	0.86 [.034]	1.40 [.055]	2.03 [.080]
22					0.94 [.037]		
20					1.04 [.041]		
24	1.02-2.54 [.040-.100]	.058	C	8.51 [.335]	0.86 [.034]	1.40 [.055]	2.79 [.110]
22					0.94 [.037]		
20					1.04 [.041]		
Tinsel	0.76-1.02 [.030-.040]	.058	D	9.65 [.380]	0.96 [.038]	1.40 [.055]	2.79 [.110]

Figure 8 (End)

E. Wire Barrel Seam

The seam between the two sides of the wire barrel must be closed adequately to confine all strands of the wire. There must be no evidence of loose wire strands or wire strands embedded in the seam. See Figure 8. If using hand tool, a gap in the wire barrel seam is permissible provided that all strands of the wire are confined and there is no evidence of loose wire strands.

F. Mating End

There must be no damage to the mating end of the receptacle contact.

G. Bend Allowance

The receptacle contact, including the cutoff tab and burr, must not be bent above or below the datum line more than the amount given in .

Side-to-side bending of the receptacle contact must not exceed the limits given in .

There must be no twist or roll in the crimped portion of the receptacle contact that will impair usage.

4. QUALIFICATION

.058 and .093 diameter pc board pins and disconnect receptacle contacts does not require agency approval.

5. TOOLING

Applicators contain the tooling for feeding and crimping strip-form terminals. Automatic machines provide the power to operate the applicator. See Figure 10 for representative images.

Tooling information for product part numbers is available from www.te.com or by calling the Product Information Center at the number at the bottom of page 1.

5.1. Hand Crimping Tools

Hand tools for product part numbers are available from the Hand Tool Search Portal on www.te.com or by calling the Product Information Center at the bottom of page 1.

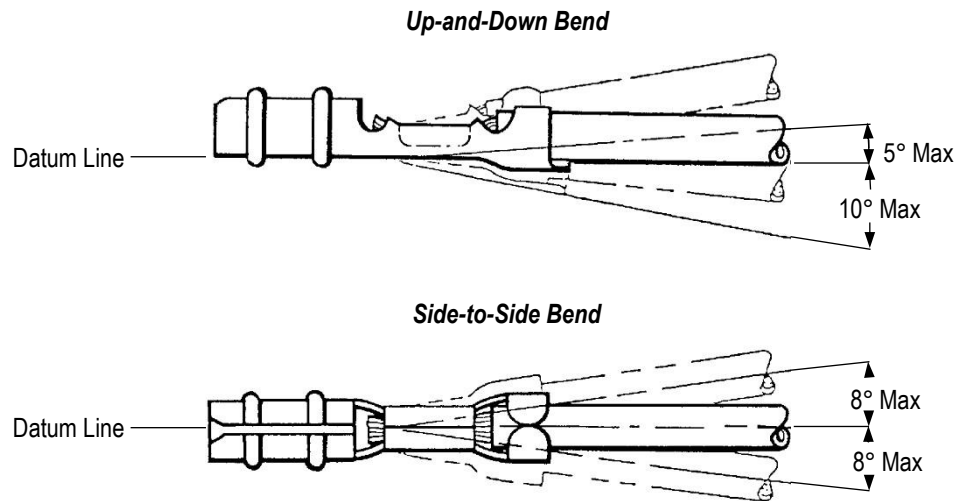

Figure 9

5.2. Applicators

Applicators for product part numbers are available from the [Applicator Search Portal](#) on www.te.com or by calling the Product Information Center at the bottom of page 1.



Figure 10

6. VISUAL AID

The illustration below shows a typical application of .058 and .093 diameter pc board pins and disconnect receptacle contacts. This illustration should be used by production personnel to ensure a correctly applied product. Applications which do not appear correct should be inspected using the information in the preceding pages of this specification and in the instructional material shipped with the product or tooling.

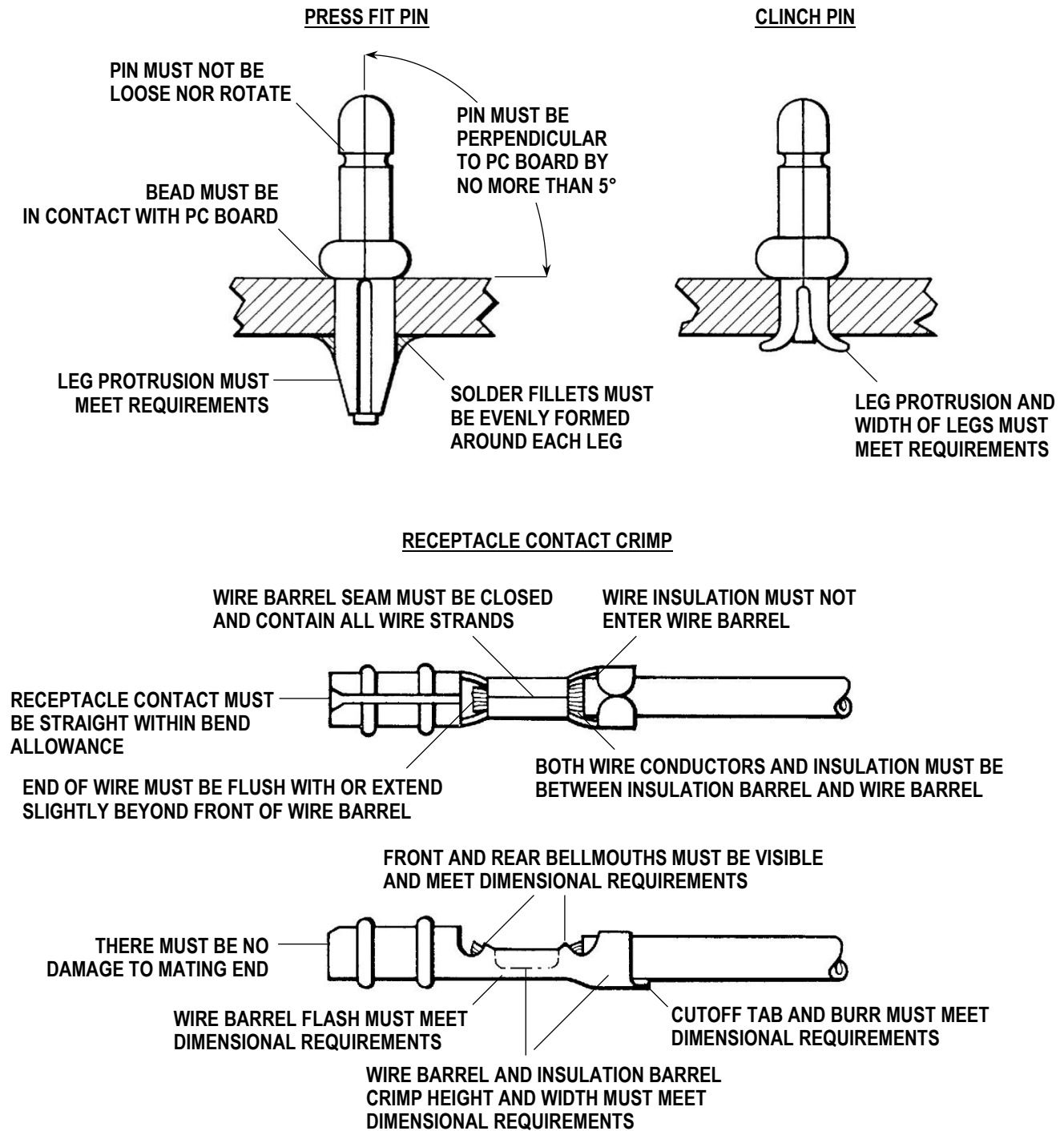

FIGURE 11. VISUAL AID