



All numerical values are in metric units [with U.S. customary units in brackets]. Dimensions are in millimeters [and inches]. Unless otherwise specified, dimensions have a tolerance of ± 0.13 [$\pm .005$] and angles have a tolerance of $\pm 2^\circ$. Figures and illustrations are for identification only and are not drawn to scale.

1. INTRODUCTION

This specification covers the requirements for application of Power Series 175 (double-pole) connector assembly in high-current systems for power supplies, battery chargers, telecommunications, and material handling equipment. The connector assembly consists of a hermaphroditic housing and two closed barrel contacts. The contacts are available in sizes 1/0, 1, 2, and 4 and accept wire sizes (AWG) that correspond to the contact size. Reducing bushings are available for contact size 1/0 to accommodate small wire sizes to a minimum of size 10 AWG.

The housing features two contact cavities each marked on top of the housing with a plus (+) to indicate positive polarity and a minus (-) to indicate negative polarity. Each contact is held in the cavity by an internal retaining spring. The hermaphroditic design of the housing ensures proper polarity in mating of the connectors. In addition, the housings are color coded to provide visual reference for proper mating and a molded-in mechanical key at the mating face prevents inadvertent mating of different colored housings (housings with same position keys will only engage housings of the same color). The housing color is also coded for voltage.

The contacts feature a flared wire barrel and round-ended tab. The contacts are available in loose-piece for terminating with manual or pneumatic hand-held tools.

When corresponding with personnel, use the terminology provided in this specification to facilitate your inquiries for information. Basic terms and features of this product are provided in Figure 1.

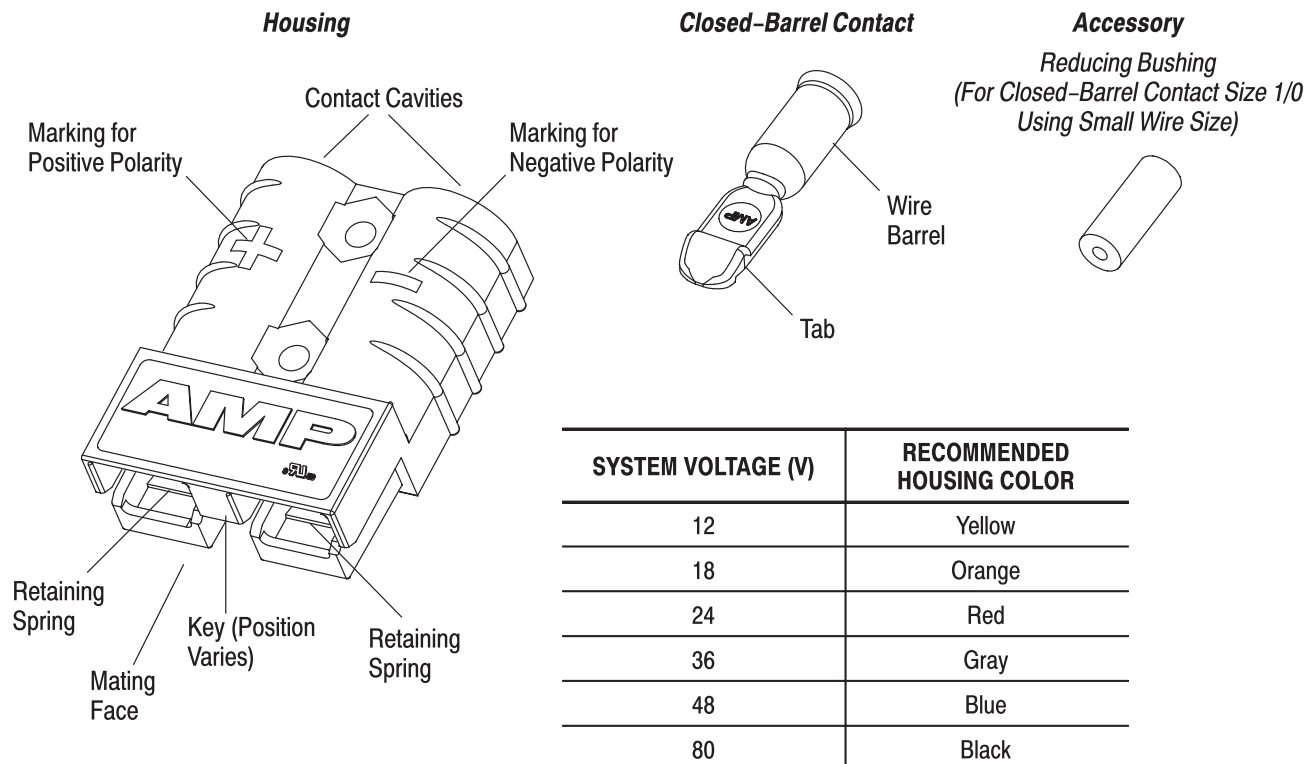

Note: Other color codes and voltage ratings are available upon request.

Figure 1

2. REFERENCE MATERIAL

2.1. Revision Summary

- Initial release of application specification

2.2. Customer Assistance

Reference Product Base Part Number 1604037 and Product Code H416 are representative of Power Series 175 (double-pole) connector assembly. Use of these numbers will identify the product line and expedite your inquiries through a service network established to help you obtain product and tooling information. Such information can be obtained through a local Representative or, after purchase, by calling PRODUCT INFORMATION at the number at the bottom of page 1.

2.3. Drawings

Customer Drawings for product part numbers are available from the service network. If there is a conflict between the information contained in the Customer Drawings and this specification or with any other technical documentation supplied, call PRODUCT INFORMATION at the number at the bottom of page 1.

2.4. Instructional Material

Instruction Sheets (408-series) provide product assembly instructions or tool setup and operating procedures. Documents available which pertain to this product are:

408-4089	Ratcheted Cable Cutter Hand Tool 607453-2
408-4557	Heavy Duty Cable Cutter Hand Tool 605742-1
408-4559	Heavy Duty Cable Cutter Hand Tool 605744-1
408-4561	Heavy Duty Cable Cutter Hand Tool 600769-1
408-8868	Power Series 175 and 350 (Double-Pole) Connector Assemblies with Cable Clamp Kits
408-9688	Cable Stripper/Slitter Tool 606700-1
408-9816	Handling Reeled Products

3. REQUIREMENTS

IMPORTANT: Using the exact products and application requirements described in this document will ensure proper application; however, to ensure reliability of performance, it is highly recommended that an independent evaluation be conducted of the chosen product combinations (wire, connector assemblies, and system) *before* final application is approved.

3.1. Special Assembly Considerations and Safety

These connectors **MUST NOT** be used for interrupting current; otherwise, there is risk of electrical shock. In any case, the electrical power supply must **ALWAYS BE DISCONNECTED**, and the connectors must **ALWAYS BE DE-ENERGIZED** (this might include disconnecting the wire from the battery) before mating and unmating or servicing the connectors.

It is highly recommended that these connectors not be used in external power applications where the electrical potential exceeds 42 V. In applications where these connectors are located internal to a device and do not serve as the primary means of connection, high voltages are allowable. It must be determined by the original equipment manufacturer (OEM) whether the connectors meet electrical and safety requirements when used in a specific application.



In applications where the connectors are used external to a device or as the primary means of disconnecting power supplies or charging equipment, care must be taken to avoid touching exposed electrical contacts as there is risk of electric shock.

3.2. Limitations

This product is designed to operate in a temperature range of -20° to 105°C [-4° to 221°F].

3.3. Material

The housing is made of polycarbonate, rated Underwriter Laboratories, Inc. (UL) 94 V-0. The springs (inside the housing) are made of stainless steel. The cable clamp is made of aluminum. The contacts and reducing bushing are made of copper plated with silver.

3.4. Storage

A. Ultraviolet Light

Prolonged exposure to ultraviolet light may deteriorate the chemical composition used in the housing material.

B. Shelf Life

The housings and contacts should remain in the shipping containers until ready for use to prevent deformation. The housings and contacts should be used on a first in, first out basis to avoid storage contamination that could adversely affect performance.

C. Chemical Exposure

Do not store housings or contacts near any chemical listed below as they may cause discoloration of the plated finish of the contacts or stress corrosion cracking in the housing or contact material.

Alkalies	Ammonia	Citrates	Phosphates	Citrates	Sulfur Compounds
Amines	Carbonates	Nitrites	Sulfur Nitrites		Tartrates

3.5. Wire Selection and Preparation

The contacts accept stranded (recommended a minimum of 19 strands) copper wire sizes 1/0, 1, 2, and 4 AWG with a maximum insulation diameter of 19.05 [0.750]. Contact size 1/0 can accept small wire sizes to a minimum of size 10 AWG with the use of the appropriate reducing bushing (as described in Paragraph 3.6).

NOTE

Wires with less than 19 strands may be too stiff and difficult to work with.



Tarnished copper wire must be thoroughly cleaned using a stiff wire brush, or other suitable method, that penetrates the entire bundle and cleans every conductor. The wire must be restored to a bright copper finish. The contact wire barrels are lined with silver plating to assure consistently high conductivity which will be reduced if tarnished wire is used.

The wire must be cut to length. Proper strip length is necessary to properly insert the conductors into the contact. The strip length of the wire is shown in Figure 2.

CAUTION

Reasonable care must be taken not to nick or scrape any part of the wire during the stripping.



Recommended Wire Strip Length

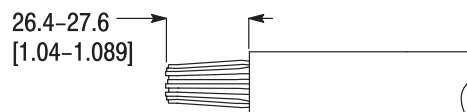

Note: Not to Scale

Figure 2

3.6. Reducing Bushing

Reducing bushings are available for contact size 1/0 to accommodate small wires to a minimum of size 10 AWG. When required, the appropriate size reducing bushing must be installed onto the wire *after* stripping the wire and *before* inserting the wire into the contact. Placement of the reducing bushing must meet the requirements shown in Figure 3.

Placement of Reducing Bushing on Stripped Wire**Placement of Reducing Bushing and Wire in Contact**

Figure 3

3.7. Crimp Requirements**A. Reducing Bushing**

If used, the reducing bushing must be held firmly inside the contact wire barrel. The reducing bushing must be straight in relation to the wire barrel and must be flush with the end of the wire barrel or protrude no more than the dimension provided in Figure 4.

B. Tab

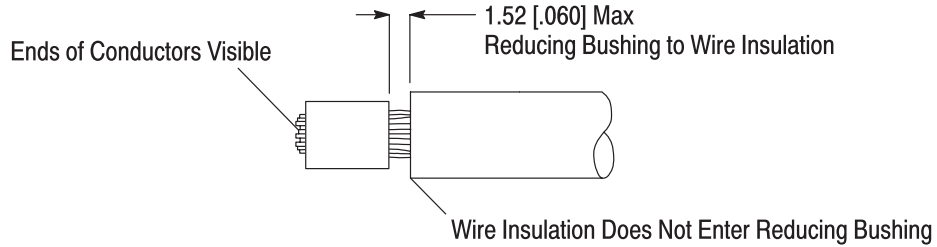
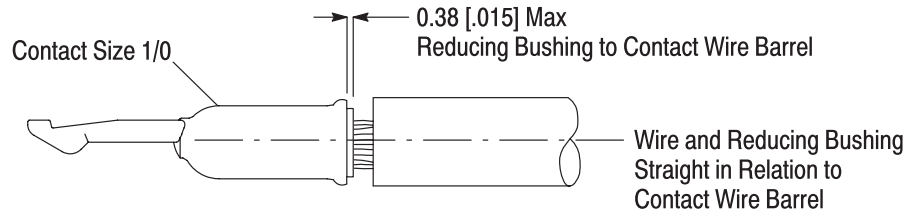
The tab must not be deformed in any way. See Figure 4.

C. Wire Barrel Crimp

All wire conductors must be held firmly inside the wire barrel. The crimp applied to the wire barrel is the most compressed area and most critical in ensuring optimum performance of the crimped contact. The crimped area must be symmetrical on both sides of the wire barrel. See Figure 4.

NOTE

The developed dual-indent crimp configuration results from using the specific tooling described in Section 5, TOOLING.

D. Wire Conductor and Insulation Location

No wire conductors can be folded back over the wire insulation. The wire insulation must not enter the wire barrel. The wire conductors must be visible between the reducing bushing, if applicable, or wire barrel and the wire insulation within the dimension given in Figure 4.

The end of the wire must be flush with the end of the wire barrel or extend no more than the dimension given in Figure 4.

E. Flash

There shall be no flash or extruded contact insulation visible in the crimped area. See Figure 4.

Crimp Requirements

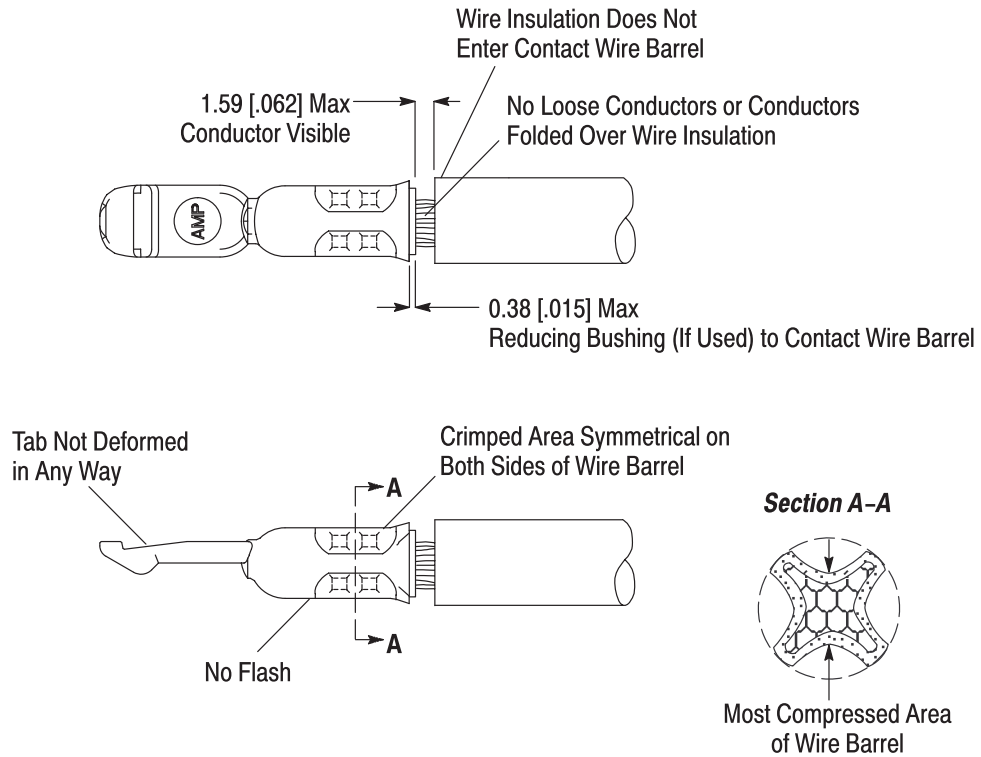

Figure 4

F. Twist and Roll

There should be no twist or roll of the wire barrel of the crimped contact that would cause overstress or impair usage. See Figure 5.

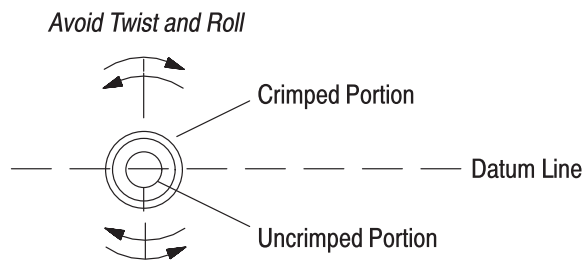

Figure 5

G. Bend Allowance

The force applied during crimping may cause some bending between the wire barrel and wire. Such deformation is acceptable within the following limits.

1. Up and Down
The crimped portion must not be bent beyond the limits shown in Figure 6.
2. Side-to-Side
The crimped portion must not be bent from one side to the other beyond the limits shown in Figure 6.

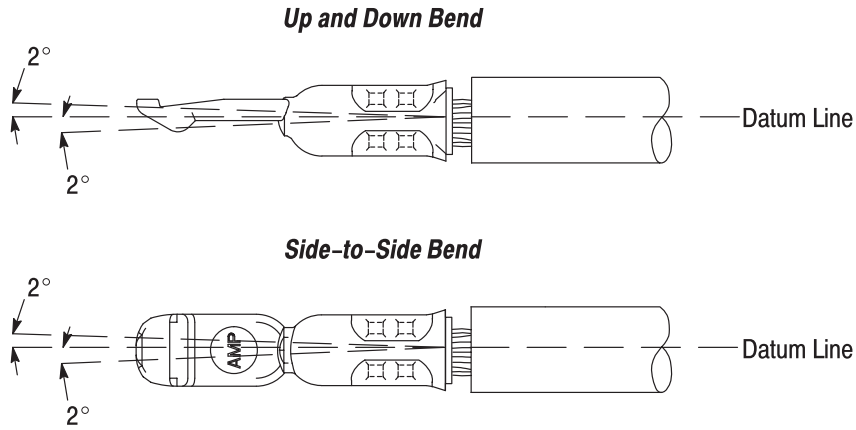



Figure 6

3.8. Keying

Assurance of proper mating is provided by a molded-in mechanical key at the mating face of the housing. The position of the key of the mating housings must be compatible. The customer drawing for the specific housing provides the key position.

NOTE *Other key positions are available upon request.*



3.9. Installing Contacts into Housing

DANGER *The electrical supply MUST BE DISCONNECTED and the connectors MUST BE DE-ENERGIZED (this might include disconnecting the wire from the battery) before installing the contacts into the housing.*



The contacts must NOT be forced into the housing. Each contact must be installed in the housing according to the following requirements.

1. Each contact must be inserted into the wire side of the housing.
2. The bottom of each contact must face the retention spring of the housing.
3. Each contact must be in straight alignment with the contact cavity.
4. Each contact must be fully latched onto the housing retaining spring.

3.10. Removing Contacts from Housing

The housing retention spring must be depressed away from the underside of the contact to remove the contact from the housing. A contact must be removed from the housing according to the following:

DANGER *The electrical supply MUST BE DISCONNECTED and the connectors MUST BE DE-ENERGIZED (this might include disconnecting the wire from the battery) before removing the contacts from the housing.*



NOTE *Section 5 lists available extraction tools used to remove these contacts.*



1. The tip of the tool must be inserted between the sides of contact and the contact cavity at the mating face of the housing.

- The handle of the tool must be pushed down so that the housing retention spring is depressed away from the underside of the contact. While holding the tool in position, the wire must be pushed down and *gently* pulled back until the contact is free from the housing.

3.11. Mating and Unmating Connectors



The electrical supply MUST BE DISCONNECTED and the connectors MUST BE DE-ENERGIZED (this might include disconnecting the wire from the battery) before mating or unmating the connectors.

The connectors must NOT be forced to mate or unmate. When fully mated, the housings must appear flush at the point of engagement.

3.12. Repair

The contact, housing, and reducing bushing are not repairable. Damaged or defective contacts, housings, or reducing bushings must not be used. The contacts or reducing bushings must not be re-used by removing the wire.

4. QUALIFICATION

Power Series 175 (double-pole) connector assembly is Component Recognized by UL under File E28476 and have been Investigated to CSA International Standards by UL.



The connector assembly meets the requirements of CSA International Standards by UL only when the cable clamps indicated in this document are used.

5. TOOLING

Tooling part numbers and instructional material packaged with the tooling are shown in Figure 7.

5.1. Cable Cutter

The cable cutter is used to cut the wire to length.

5.2. Stripping Tool

The cable stripper is used to strip insulation from the wire.

5.3. Hand Crimping Tool

Industry standard tooling for pneumatic application of loose piece contacts is available for the full wire size range. Recommended manufacturer and contact information is Pico Corporation, Camarillo, CA (805) 388-5510 (<http://www.picotools.com>).



Consult manufacturer's literature for information on using the tooling.

5.4. Extraction Tool

The extraction tool is designed to remove contacts from the housing by releasing the contact locking lance without overstressing the contact. A standard insulated screwdriver with a $\frac{1}{4}$ -in. blade can also be used to remove the contacts from the housing.

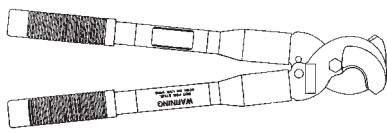

Heavy Duty Cable Cutter Hand Tool
600769-1 (408-4561)

Heavy Duty Cable Cutter Hand Tool
605742-1 (408-4557)

Heavy Duty Cable Cutter Hand Tool
605744-1 (408-4559)

Ratcheted Cable Cutter Hand Tool
607453-2 (408-4089)

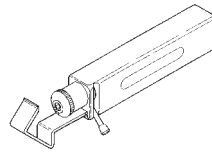

Cable Stripper/Slitter Tool
606700-1 (408-9688)



Extraction Tool 68265-1
(No Document)

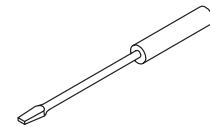

Standard Insulated Screwdriver
With 1/4-in. Flat Blade

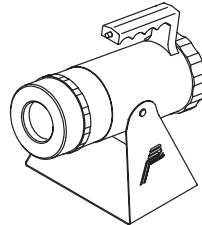

Pneumatic Power Crimping Tool with Locator and Die
(Commercially Available from Pico Corporation)
(See Table)

CRIMPING TOOL MODEL SERIES	DIE	DIE CLOSURE DIMENSION●	LOCATOR
500 DEC	514DA-10023	5.72 [.225]	10034-1

● Die closure dimension is not crimp height dimension. If the die is dimensionally correct, the crimp height will be correct.

Figure 7

6. VISUAL AID

The illustration below shows a typical application of Power Series 175 (double-pole) connector assembly. This illustration should be used by production personnel to ensure a correctly applied product. Applications which DO NOT appear correct should be inspected using the information in the preceding pages of this specification and in the instructional material shipped with the product or tooling.

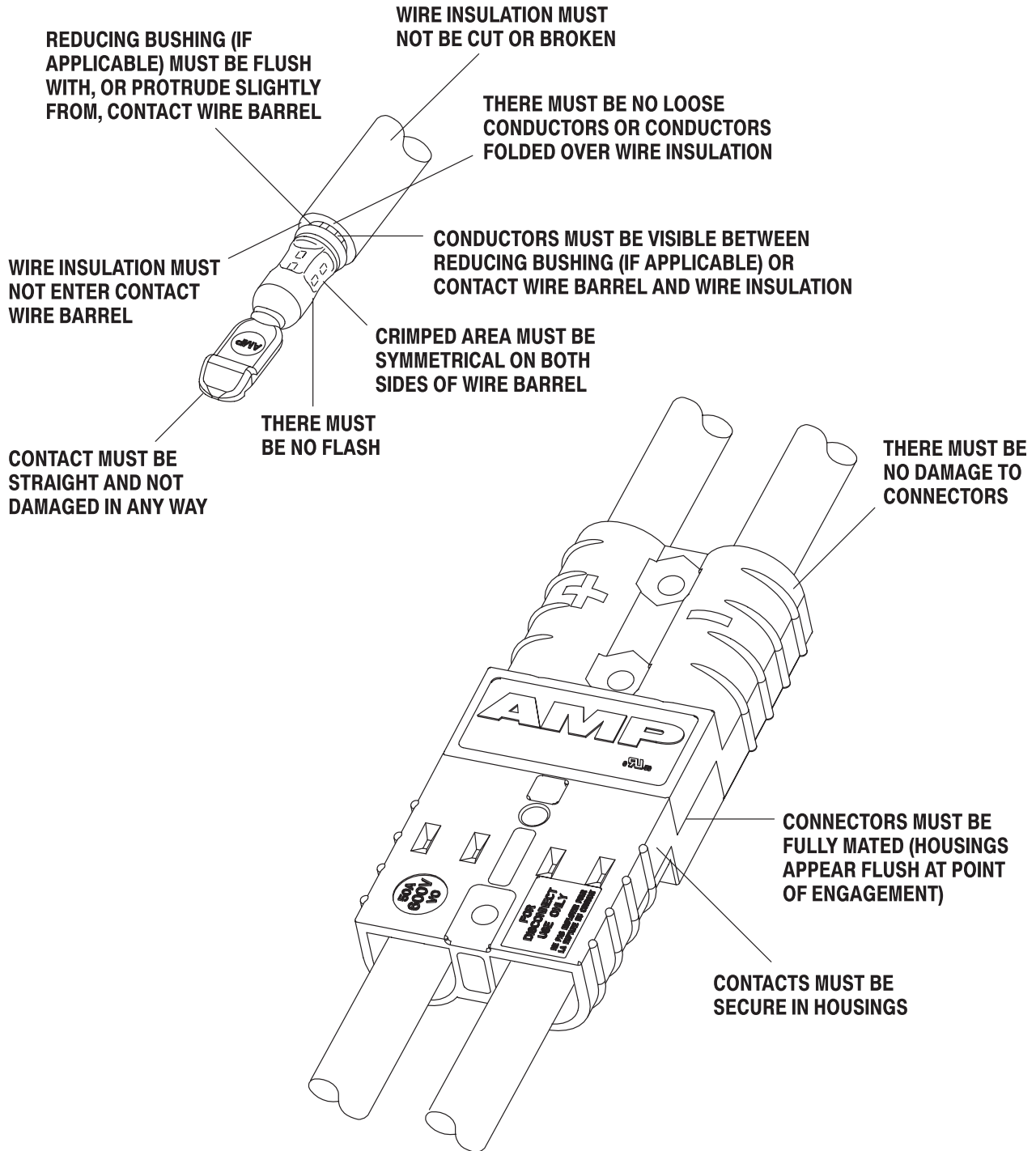

FIGURE 8. VISUAL AID