



Cable gland Series

Table of contents

1. INTRODUCTION	2
2. SUPPORTING DOCUMENTS	2
2.1. Customer drawings.....	2
2.2. Product specification	2
2.3. Application Specification.....	2
2.4. Standards	2
3. DESCRIPTION	3
3.1. Assembly product.....	3
3.2. Cable gland types.....	4
4. REQUIREMENTS	6
5. Cable gland selection	6
6. ASSEMBLY.....	7
7. STORAGE	7

1. INTRODUCTION

This specification contains the regulations for assembly of various Cable Gland.

The following components are available in this system:

Item	Type
1	Metal cable gland
2	Multiple sealing insert metal cable gland
3	Metal cable gland special sealing
4	Metal cable gland EMC
5	Metal flat glands with multiple seal
6	Metal flat glands with normal seal
7	Clamp gland with normal seal
8	Metal clamp glands with multiple seal
9	Plastic cable gland
10	Multiple sealing insert nylon cable gland
11	Metal increasers
12	Metal reducers

2. SUPPORTING DOCUMENTS

2.1. Customer drawings

For dimensions and materials of the individual parts, please refer to the relative customer drawings.

2.2. Product specification

The product specifications of the used articles are to be taken into account. The product specification describes the technical data as regulations, temperature range and degree of protection. For further reference, please refer to product spec. 108-137475.

2.3. Application Specification

Connectors shall be assembled as below mentioned application specifications to ensure correct connector assembly.

2.4. Standards

- EN 61984: Connectors - Safety requirements and tests
- EN 60529: Degrees of Protection Provided by Enclosures (IP Code)
- EN 60068: Environmental testing

3. DESCRIPTION

3.1. Assembly product

The following picture (Figure 1-1) shows an example of complete metal assembly product.



Figure: 1-1

The complete product consists of the following components (see figure 1-1):

- Nut of metal cable gland
- Inner sealing
- Metal gland pinch ring
- Body of metal cable gland

The following picture (Figure 1-2) shows an example of complete plastic assembly product.

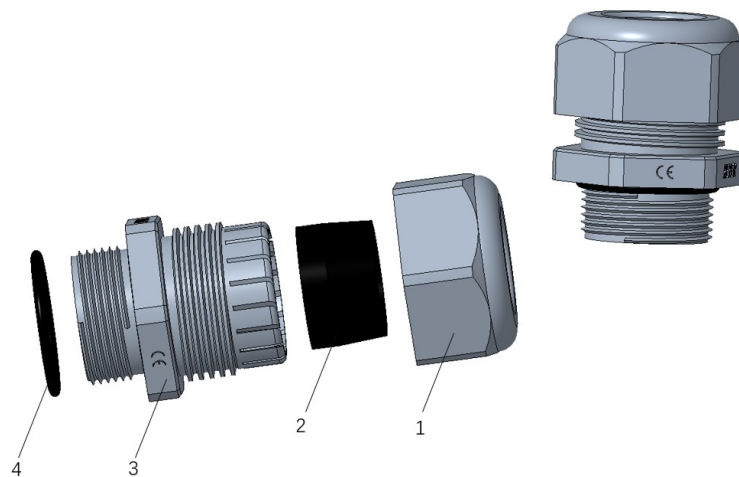
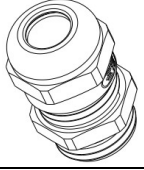

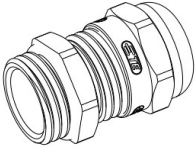
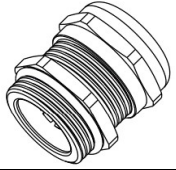
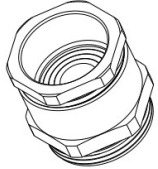





Figure: 1-2

The complete product consists of the following components (see figure 1-2):

- Nut of plastic cable gland
- Inner sealing
- Body of plastic cable gland
- O-ring

3.2. Cable gland types

ITEM	TYPE	CUSTOMER DRAWING	PICTURE
1	METAL CABLE GLAND	C-T360XXXXXXXX000	
2	MULTIPLE SEALING INSERT METAL CABLE GLAND	C-T3729XXXXXXXX000	
3	METAL CABLE GLAND SPECIAL SEALING	C-T3709XXXXXXXX000	
4	METAL CABLE GLAND EMC	C-T3707200113000 C-T3707250113000 C-T3707320113000 C-T3707400113000	
5	METAL FLAT GLANDS WITH MULTIPLE SEAL	C-T3101XX010X000	
6	METAL FLAT GLANDS WITH NORMAL SEA	C-T3111XX010X000	
7	METAL CLAMP GLAND WITH NORMAL SEA	C-T3115XXX1X1X00	

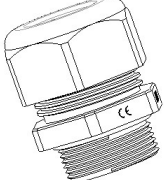
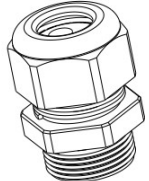
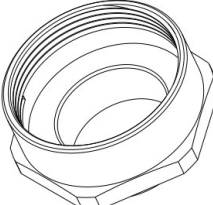
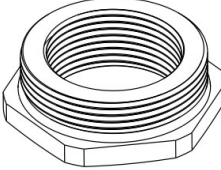
8	METAL CLAMP GLANDS WITH MULTIPLE SEAL	C-T3135XX01X1X00	
9	PLASTIC CABLE GLAND	C-T3209XXXXXX00X	
10	MULTIPLE SEALING INSERT NYLON CABLE GLAND	C-T3229XXXXXX000	
11	METAL INCREASERS	C-T3033XXXXXX000	
12	METAL REDUCERS	C-T3071XXXXXX000	

Note:

Above are the hoods for the typical applications. For the special applications, also can be provided.
 More customer drawing of Item 4 METAL CABLE GLAND EMC please contact sales
 Different size has different optional entry threads. Refer to drawings for the detailed information.

REQUIREMENTS

Cable gland torque

Thread	Torque on the hood /net side thread (N·m)		Torque on the cable side thread (N·m)	
	metal	plastic	metal	plastic
PG7/M10/M12	4.17	1.2	3.5	1.3
PG9/M16	4.17	1.5	6.25	2.5
PG11/M18	4.17	2	6.25	3.75
PG13.5/M20	4.17	2	6.25	3.75
PG16/M22/M24	5	3.33	7.5	5
M25	6.67	3.33	10	7.5
PG21/M27/M30	6.67	5	10	7.5
PG29/M32/M33/M36	6.67	5	10	7.5
PG36/M40/M42/M48	6.67	5	10	7.5
PG42/M50/M56	6.67	5	10	7.5
PG48/M63/M64	6.67	5	12.5	10

4. Cable gland selection

- 1) According to cable diameter selects a suitable wire range of cable gland.
 - 2) According to screw on hoods or housings select a suitable thread type (PG/M) of cable gland.
- For example, the cable diameter is 18mm. METAL CABLE GLAND PG21 (wire range: 13-18) and METAL CABLE GLAND M25 (wire range: 13-18) are ok. Then, the thread on hood is M25. Finally, METAL CABLE GLAND M25 (wire range: 13-18) is suitable.

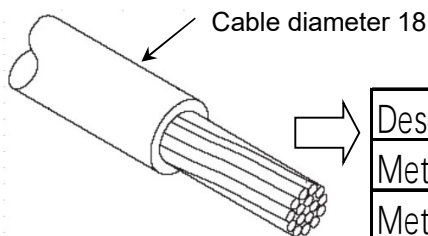

Description	type	wire range
Metal cable gland PG21(13-18)	DLX-21-MS	13-18
Metal cable gland M25(13-18)	DLX-25-M	13-18

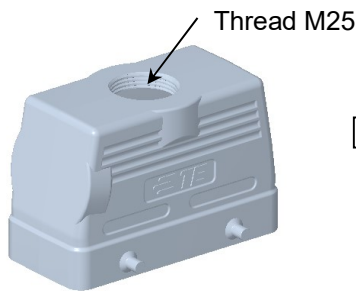

Description	type	wire range
Metal cable gland M25(13-18)	DLX-25-M	13-18

Figure: 2

5. ASSEMBLY

According to

Step 1: Fixing cable gland to hood;

Step 2: Inserting cable;

Step 3: Tightening cable gland up. Tightening torque refer to Cable gland torque.

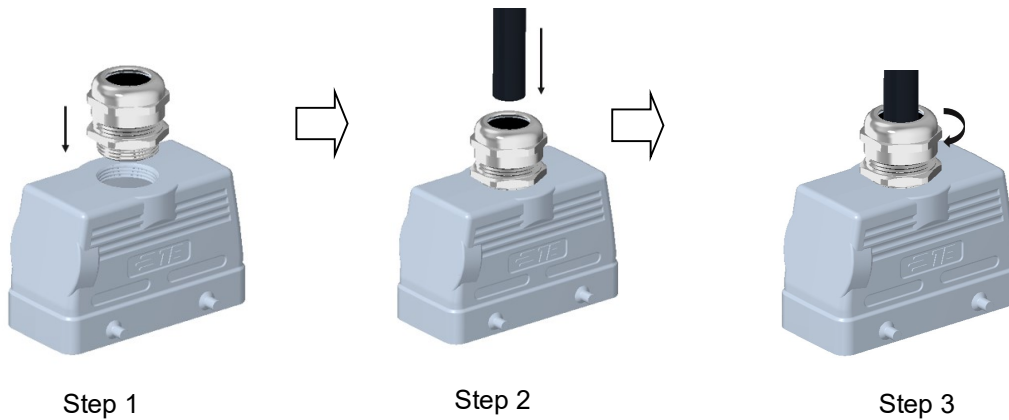

6. STORAGE

The connectors should be stored in the air ventilation, no corrosive gas, no rain and no snow in the warehouse. Relative humidity: less than 85% RH.

NOTE Any conflict is found between this file and customer drawings, customer drawings are preferential.
 And please contact TE Connectivity related engineer if necessary.

----- End -----