

NOTE



All numerical values are in metric units [with U.S. customary units in brackets]. Dimensions are in millimeters [and inches]. Unless otherwise specified, dimensions have a tolerance of ± 0.13 [± 0.005] and angles have a tolerance of $\pm 2^\circ$. Figures and illustrations are for identification only and are not drawn to scale.



A In the event that there are difference between the information presented in this application specification versus the information found in other instruction material, this application specification will take precedence.

1. INTRODUCTION

This specification covers the requirements for application of DEUTSCH size 4 through 20 Solid pins and socket contacts. These contacts are used in any DEUTSCH connectors having size 4 to 20 contact cavities. Each contact features a wire crimp barrel, retention shoulder, wire inspection hole and mating end. The socket features a protective sleeve. In use, the retention shoulder holds the contact in the connector. The contacts are available in loose-piece form for terminating using a pneumatic power press or hand tool.

When corresponding with personnel, use the terminology provided in this specification to facilitate inquiries for information. Basic terms and features of this product are provided in Figure 1. Size 16 Shown as example. See Table 1 for other sizes.

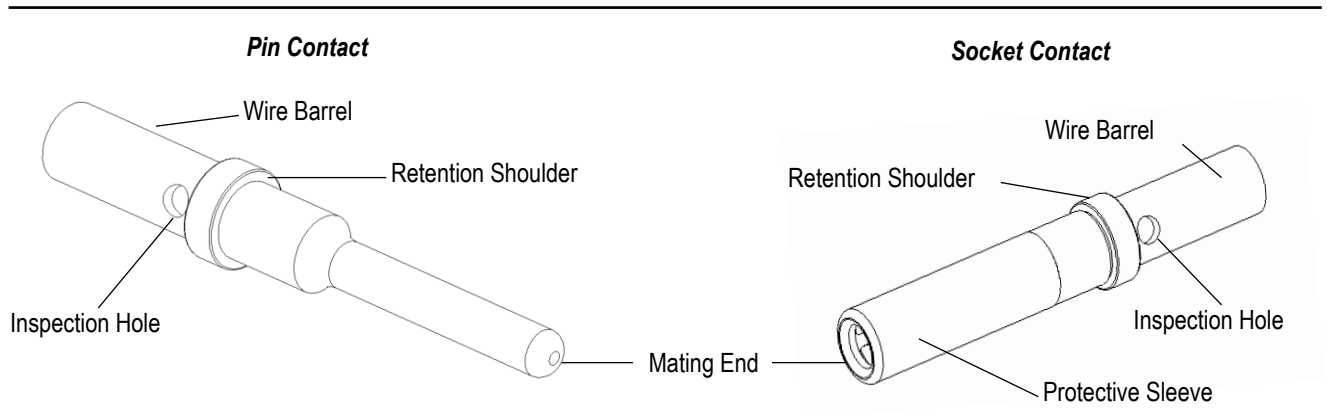

Figure 1

2. REFERENCE MATERIAL

2.1. Revision Summary

- See Section 7

2.2. Customer Assistance

Product Base Part Numbers (listed below) and Product Code (listed below) are representative of DEUTSCH Solid pin and socket contacts. Use of these numbers will identify the product line and help you to obtain product and tooling information. Information can be obtained by visiting our website at www.te.com or calling the number at the bottom of this page.

Contact Size	Size 4	Size 4	Size 8	Size 12	Size 16	Size 20
Product Code	J823	J827	J824	J825	J826	J827
Pin PN	5960-XXX-04	0460-XXX-04	0460-XXX-08	0460-XXX-12	0460-XXX-16	0460-XXX-20
Socket PN	5962-XXX-04	0462-XXX-04	0462-XXX-08	0462-XXX-12	0462-XXX-16	0462-XXX-20











Size	Pin Contact	Socket Contact
4		
8		
12		
16		
20		

Table 1



Nickel Plate Shown as example

2.3. Drawings

Customer drawings for product part numbers are available from www.te.com. The information contained in the customer drawings takes priority.

2.4. Instructional Material

Instructional material that pertains to this product are:

108-151004	DEUTSCH Solid Contacts (HD)
408-7424	Checking Terminal Crimp Height and Gaging the Die Closure
408-32108	HDT-50-00 Hand Crimp Tool
408-32109	HDT-1561 Hand Crimp Tool
408-32124	HDT-04-08 Hand Crimp Tool
408-151007	DEUTSCH Extraction Tools for Rear-Release Connectors
408-151008	DEUTSCH Removal Tool DT-RT1 for Front-Release Connectors
0425-034-0000	HDP-400 Power Crimp Press
0425-071-0000	HDT-48-00 Hand Crimp Tool
0425-079-0000	PDT-48-00 Power Crimp Tool

2.5. Global Standards and Publications

DIN 72551-6: Road Vehicles—Low-Tension Cables—Part 6: Single-Core, Unscreened with Thin Insulation Wall; Dimensions, Materials, Marking

ISO 6722: Road Vehicles—60 V and 600 V Single-Core Cables—Dimensions, Test Methods, and Requirements

SAE J1128: Low Voltage Primary Cable

SAE J1127: Low Voltage Battery Cable

3. REQUIREMENTS

3.1. Storage

A. Ultraviolet Light

Prolonged exposure to ultraviolet light may deteriorate the chemical composition used in the product material.

B. Shelf Life

The product should remain in the shipping containers until ready for use to prevent deformation to components. The product should be used on a first in, first out basis to avoid storage contamination that could adversely affect performance.

C. Chemical Exposure

Do not store product near any chemical listed below as they may cause stress corrosion cracking in the material.

Alkalis	Ammonia	Citrates	Phosphates	Sulfur Compounds	Acids
Amines	Carbonates	Nitrites	Sulfur Nitrites	Tartrates	

3.2. Operating Temperature

These contacts are designed to operate in a temperature range of -55 to 125°C [-67 to 257°F].

3.3. Material

The contacts body are made of copper alloy and the protective sleeve is stainless steel. Plating material is provided on the contact-specific customer drawing.

3.4. Wire Size and Preparation

The contacts accept stranded wire sizes and insulation diameters using wire standards in Section 2.5. For insulation diameter per contact, refer to the customer drawing for the contact. The wire must be stripped within the dimensions given in Figure 2. Special wire type which may require special applicator tooling settings, crimp requirements are not covered in this specification.



CAUTION

The wire conductors and insulation must not be nicked, scrapped, broken, or cut during the stripping operation.

Contact Size	Strip Length mm [In]
Size 4	10.92-12.50 [.430 - .492]
Size 8	10.92-12.50 [.430 - .492]
Size 12	5.64 - 7.21 [.222 - .284]
Size 16	6.35 - 7.92 [.250 - .312]
Size 20	3.96 - 5.54 [.156 - .218]

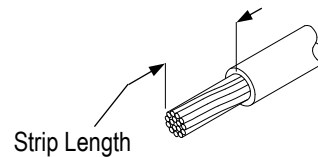

Note: Not to Scale

Figure 2

3.5. Crimp

The contact must be crimped to the wire according to instructions packaged with the tooling. These requirements apply equally to the pin contact and the socket contact. Refer to the applicator instruction sheet for adjustment instructions.

A. Wire Barrel Crimp

The crimp applied to the wire barrel portion of the contact must be the most compressed area. All conductors within the wire barrel crimp must show evidence of compression. Good compression is guaranteed by following the given crimp dimensions, Figure 3. The crimp barrel is filled with the conductor strands. All conductor strands within the wire crimp must show evidence of compression. The crimped area must be symmetrical for both crimp indent. The thickness of the wall must be uniform.

The crimp barrel inside wall is formed to the shape of the strands for an intimate contact. All existing wire strands are enclosed within the wire barrel. Any stranding outside the crimp barrel or broken strands outside the wire crimp are not permissible. If low compression occurs, the number of strands should be checked.

The wire barrel crimp height must be within the dimensions provided in Figure 3.

B. Wire Conductor

The wire conductor must be visible in the inspection hole. given in Figure 3.

C. Mating End

The mating end of the contact must not be bent or damaged in any way. See Figure 3.

D. Bend Allowance

No Bend Allowance

E. Assembly Instructions

1. Strip and remove wire insulation. See Figure 2.
2. Insert stripped wire into the pin contact or socket contact. Verify cable strands are visible through the inspection hole prior to crimping. See Figure 3.
3. Insert wire/contact assembly into either pneumatic or manual crimp tool. Verify placement of crimp indents is centered between inspection holes and end of wire crimp barrel. See Figure 3.

F. Crimp Height Inspection

Measure across opposite indents in the contact, then rotate the contact 90° and measure again. Do not go beyond initial contact as this could cause a depression and results in an inaccurate reading.

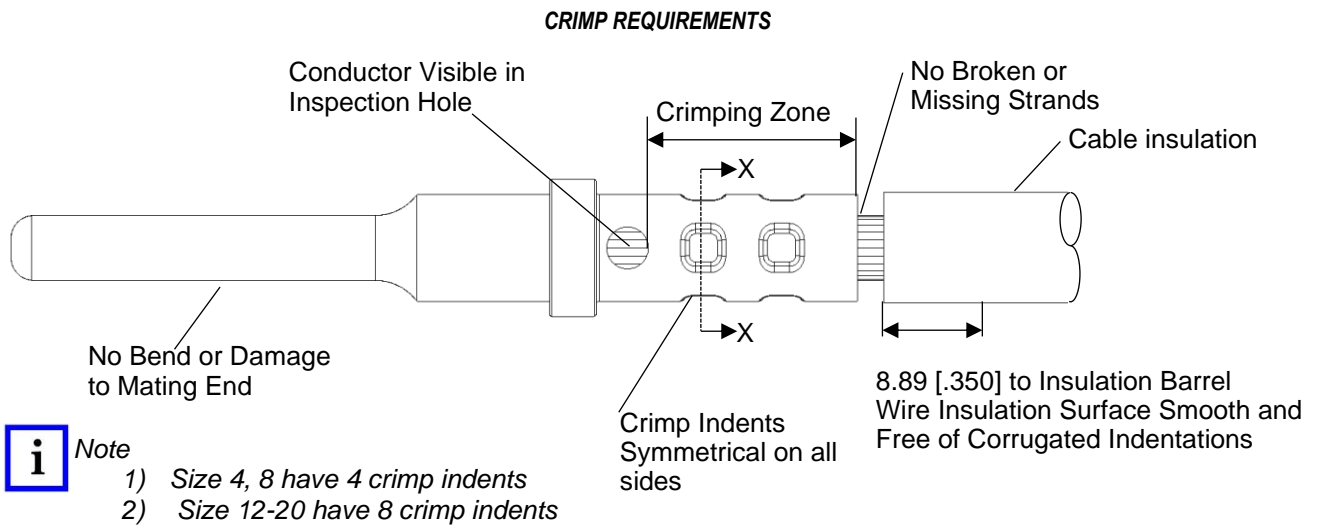

Size 4
4 AWG SGX

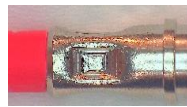

Size 8
8 AWG GXL



Size 12
12 AWG GXL



Size 16
16 AWG GXL



Size 20
20 AWG GXL

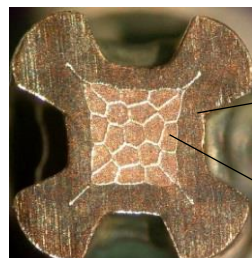

Section X-X

Uniform Wall thickness all around

No Voids in Crimp Compression Area

Crimp Height Inspection

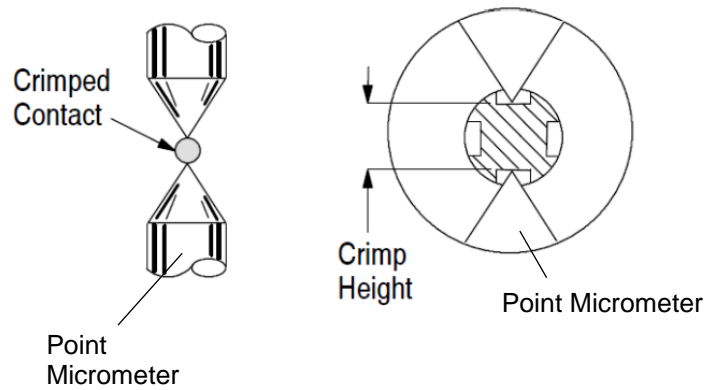

Acceptable Wire Barrel Crimp

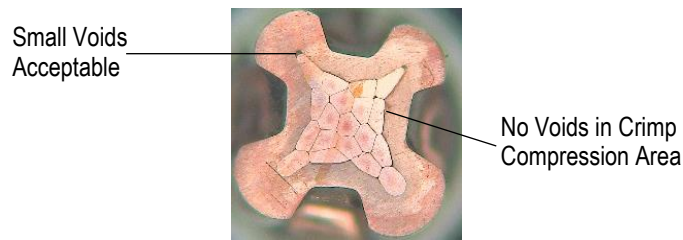

Unacceptable Wire Barrel Crimp

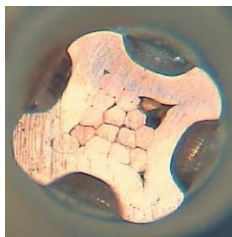

Crimp Too Loose and Voids in the Crimp



Uneven Crimp and Wall Thickness

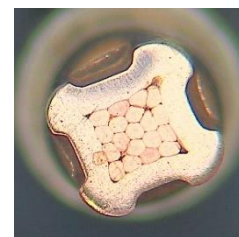

Crimp Too Loose and Void on Within Crimp

Figure 3 (End)



NOTE

1. Periodic inspections must be made to ensure crimped contact formation is consistent.
2. Periodic inspection of applicator tooling must be made to ensure parts are tightened in the correct position.
3. Perform regular maintenance and tool wear inspection by Checking with the Go and No-Go Gauges.

3.6. Processing

Care must be taken when transporting, storing, or processing crimped contacts and wires that any damage or soiling of the contact body or crimped area is avoided. When processing the end of the wire or anywhere along the wire, damage or impairment of the crimped contact must be avoided.

For a twisting operation after crimping or inserting a contact to a connector, the twist must end at least 35 [1.38] away from the contact. Additional care must be taken during or after the twisting operation to avoid any pulling force to the contact or crimped area that may affect the function of the connector.

TE has not tested, nor otherwise verified, contact performance after processing of the connected wire by soldering. TE does not make any representation or warranty, expressed or implied, and disclaims any and all liability, on any legal basis whatsoever, for contact performance after soldering of the connected wire. Customer takes sole responsibility for the evaluation, application, and use of contacts in such circumstances.

3.7. Replacement and Repair

Damaged or worn contacts cannot be repaired. A contact can be replaced provided there is sufficient slack to insert the new contact into the connector. An extraction tool must be used to remove individual contacts from the connector.

4. QUALIFICATION

Refer to individual product specification for DEUTSCH connectors for qualification and approved agency.

5. TOOLING

Tooling part numbers and related instructional material are given in Figure 4.

5.1. Hand Tools

The hand crimping tools consist of a handle assembly with integral fixed crimping dies. The dies have crimping indenters used to crimp the contact onto pre-stripped wire. [HDT-48-00](#) and [PDT-48-00](#) have adjustable locator.

5.2. Applicators

The [HDP-400](#) applicator is designed to crimp loose piece contacts and provides for heavy duty production requirements. These applicators accept interchangeable crimping dies and locators. A pneumatic accelerator is included to make sure the complete crimp cycle is less than one second crimp.

5.3. Extraction Tools and Removal Tool

The extraction tools and removal tool are designed to remove the contacts from the connectors by releasing the contact retention fingers from the housing without overstressing any part of the contact.

5.4. Crimping Dies

The dies are designed to be installed into an applicator. The dies form the crimp when crimping the contact.

5.5. Locator

The Locators are designed to be installed into an applicator the locator's Position the contact in the applicator

5.6. Micrometer

A point micrometer should be used to measure contact crimp height. See [408-7424](#).

*Crimp Locator and Dies
Illustrations are Representatives*

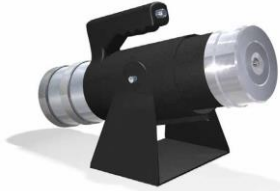

Power Crimp Press
HDP-400
(0425-034-0000)



Locator
Refer to table



Die assembly
Refer to table



Mounting Base for PDT-48-00
BM-2A



Power Crimper PDT-48-00
Size 12-20 only
Wire Size 12-22 AWG
(0425-079-0000)



M22520/7 Hand Crimping Tool
M22520/7-01 Crimper
M22520/7-02 Positioner for Size 20
M22520/7-03 Positioner for Size 16
Use SEL.4 for Wire Size 24 AWG



Hand Crimping Tool HDT-48-00
Size 12, 16, 20 only
Wire Size 12-22 AWG
(0425-071-0000)



Hand Crimping Tool HDT-04-08
Size 4, 8 only
(408-32124)



Hand Crimping Tool HDT-50-00
Size 12, 16, 20 only
Wire Size 12-20 AWG
(408-32108)



Removal Tool DT-RT1 for Front-Release Connectors (408-151008)



Extraction Tools
(408-151007)



Point Crimp Height Micrometer
408-7424

Figure 5

Table is specific to HDT-48-00

Size	Comments	Contact Part Number ⁽¹⁾	Wire Range ⁽⁴⁾ mm ² [AWG]	Crimp Tensile ⁽²⁾ N [lbf]	Crimp Height Lock ⁽⁶⁾ mm [in]	Crimp Height Entry ⁽⁶⁾ mm [in]	Dial Setting mm ² [AWG]
12	A	0460-204-12XX	3.0 [12]	334 [75]	1.38-1.51 [.054-.059]	1.55-1.71 [.061-.067]	3.0 [12]
		0462-203-12XX					
	B	0462-210-12XX	2.5 [14]	311 [70]	1.29-1.40 [.051-.055]	1.34-1.62 [.053-.064]	
		0460-220-12XX					
16	D	0460-002-16XX	1.0 [16]	156 [35]	0.94-1.05 [.037-.041]	1.13-1.25 [.042-.048]	1.0 [16]
		0462-004-16XX					
		0460-202-16XX	0.75 [18]	111 [25]	0.85-0.94 [.034-.037]	1.07-1.15 [.042-.045]	0.75 [18]
		0462-201-16XX					
	E	2325529-1 (pin)	0.50 [20]	67 [15]	0.78-0.87 [.031-.034]	0.99-1.06 [.039-.042]	0.50 [20]
	F	2325584-1 (soc)					
	K	2300908-1 (pin)	0.35 [22]	45 [10]	0.65-0.75 [.026-.029]	0.86-0.97 [.034-.038]	0.35 [22]
		0462-006-16XX					
	G	0460-215-16XX	2.0 [14]	311 [70]	1.06-1.31 [.042-.052]	1.28-1.52 [.050-.060]	1.5
		0462-209-16XX					
20	H	0460-010-20XX	1.0 [16]	89 [20]	0.90-0.98 [.036-.039]	1.06-1.22 [.042-.048]	1.0 [16]
		0462-005-20XX					
	L	0460-202-20XX	0.50 [20]	89 [20]	0.73-0.82 [.029-.032]	0.95-1.02 [.037-.040]	0.50 [20]
		0462-201-20XX					
	I	2325531-1 (pin)	0.35 [22]	45 [10]			0.35 [22]
	J	2325530-1 (soc)					

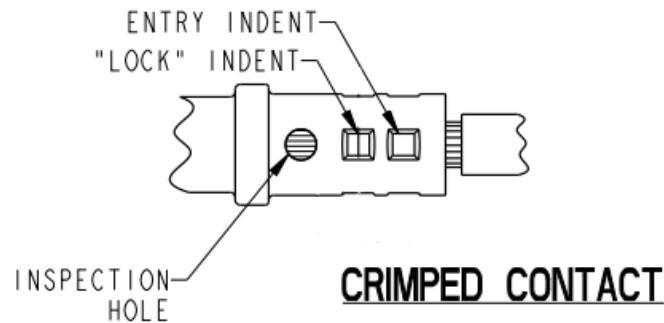

Table is specific to HDP-400

Size	Comments	Contact Part Number ⁽¹⁾	Wire Range ⁽⁴⁾ mm ² [AWG]	Crimp Tensile ⁽²⁾ N [lbf]	Crimp Height ⁽⁶⁾ mm [in]	Tooling Part Numbers		Gages		
						Crimp Die PN	Locator PN	Gage PN	Description mm [IN]	
4		5960-203-04XX	21.0-25.0 [4]	1334 [300]	4.98-5.13 [0.196-0.202]	400-414DA-4SPEC	400-4301-4S	450GA-4SPEC	4.32 [170] GO 4.50 [177] NO-GO	
		5962-203-04XX								
		0460-204-04XX	13.0-16.0 [6]							4.98-5.13 [0.196-0.202]
		0462-203-04XX								
8		0460-204-08XX	8.0 [8]	556 [125]	3.61-3.86 [0.142-0.152]	400-414DA-8SPEC	400-4301-8S	450GA-8SPEC	3.28 [129] GO 3.45 [136] NO-GO	
		0462-203-08XX	5.0-6.0 [10]	400 [90]						
12	A	0460-204-12XX	2.5-3.0 [12] 2.0 [14]	334 [75] 311 [70]	1.73-1.83 [0.068-0.072]	400-414DA-12N	400-4301-12S	450GA-12N	1.60 [063] GO 1.78 [070] NO-GO	
		0462-203-12XX								
	0460-211-12XX									
	B	0462-210-12XX								
		0460-220-12XX								
	C	0462-214-12XX								
		0460-235-12XX								
		0462-215-12XX								
0460-258-12XX										
	0460-256-12XX	1.0-1.5 ⁽⁵⁾ [16] 0.75 [18]	111 [25]	1.78-1.88 [0.070-0.074]	400-414DA-12N	400-4301-12S	450GA-12N	1.60 [063] GO 1.78 [070] NO-GO		
	16	D	0460-002-16XX	1.0-1.5 ⁽⁵⁾ [16] 0.75 [18]	156 [35] 111 [25]	1.09-1.19 [0.043-0.047]	400-414DA-16N048 Use for 0.75-1.50 [16-18]	400-4301-16S	450GA-16N	1.09 [043] GO 1.27 [050] NO-GO
0462-004-16XX										
0462-007-16XX										
0460-202-16XX										
0462-201-16XX										
0460-211-16XX										
0462-214-16XX										
0460-235-16XX		0.50 [20]	67 [15]							
0460-264-16XX										
E		2325529-1 (pin)								
F		2325584-1 (soc)								
			0462-221-16XX	1.0-1.5 ⁽⁵⁾ [16] 0.75 [18]	156 [35] 111 [25]	1.09-1.19 [0.043-0.047]	400-414DA-16N048	400-4301-16S	450GA-16N	1.09 [043] GO 1.27 [050] NO-GO
	0462-222-16XX									
	0460-247-16XX									
	0462-221-16XX									
		0462-222-16XX	0.50 [20]	67 [15]	0.91-1.02 [0.036-0.040]	400-414DA-20N	400-4301-16S	450GA-20N	0.84 [033] GO 1.01 [040] NO-GO	
		0460-247-16XX								
K		2300908-1 (pin)	0.35 [22]	45 [10]	0.71-0.79 [0.028-0.031]	2380056-1 (400-414DA-22N)	400-4301-16S	2381197-1 (450GA-22N)	0.69 [027] GO 0.86 [034] NO-GO	
		0462-006-16XX	0.22 [24]	22 [5]						
G		0460-215-16XX	2.0 [14]	311 [70]	1.09-1.19 [0.043-0.047]	400-414DA-16N048	400-4301-16S	450GA-16N	1.09 [043] GO 1.27 [050] NO-GO	
		0462-209-16XX								
20	H	0460-010-20XX	1.0 [16]	89 [20]	0.91-1.02 [0.036-0.040]	400-414DA-20N	400-4301-20S	450GA-20N	0.84 [033] GO 1.01 [040] NO-GO	
		0462-005-20XX	0.75 [18]							
	L	0460-202-20XX	0.50 [20]	89 [20]	0.91-1.02 [0.036-0.040]	400-414DA-20N Use for 0.50 [20]	400-4301-20S	450GA-20N	0.84 [033] GO 1.01 [040] NO-GO	
		0462-201-20XX	0.35 [22]	45 [10]	0.71-0.79 [0.028-0.031]	2380056-1 (400-414DA-22N) Use for 0.22-0.35 [22-24]				
	I	2325531-1 (pin)	0.22 [24]	22 [5]	0.71-0.79 [0.028-0.031]	2380056-1 (400-414DA-22N) Use for 0.22-0.35 [22-24]	400-4301-20S	2381197-1 (450GA-22N)	0.69 [027] GO 0.86 [034] NO-GO	
J	2325530-1 (soc)	0.22 [24]	22 [5]	0.71-0.79 [0.028-0.031]	2380056-1 (400-414DA-22N) Use for 0.22-0.35 [22-24]	400-4301-20S	2381197-1 (450GA-22N)	0.69 [027] GO 0.86 [034] NO-GO		



**NOTE**

1. XX is plating code. See individual customer drawing for available plating.
 - XX = 31: GOLD
 - XX = 90 or 141: Size 4 pin only. NICKEL
 - XX = 141: NICKEL
 - XX = 309: TIN
2. Crimp tensile pull rate is 25.4 [1.000] per minute. Actual crimp tensile depends on wire size.
3. Optional Foot pedal, PN 400-104
4. Metric wire sizes are for references only. (All contacts were validated with AWG wires.)
5. Metric conversion based on AWG wire dimensions.
6. Crimp heights are for reference only. Use tensile strength for crimp validation.

**Comments**

- A. "Nickel (141) only" - See 0460-220-1231 and 0462-201-1231 for gold
- B. "Gold (31) only" - See 0460-204-12141 and 0462-203-12141 for nickel
- C. Has gray, brown, brown stripes
- D. Used on high durability applications Has blue stripe
- E. "Gold only" - Has brown, brown, brown stripes
- F. "Gold only" - Has brown, brown, blue stripes
- G. Has green stripe
- H. Has purple stripe
- I. "Gold only" - has brown, brown, black stripes
- J. "Gold only" - Has brown, brown, green stripes
- K. "Gold Only"
- L. 0.22-0.35mm² (22-24AWG) can only be used with "Gold" finish contacts

6. VISUAL AID

The illustration below shows a typical application of DEUTSCH size 16 Solid pin contacts. This illustration should be used by production personnel to ensure a correctly applied product. Applications which DO NOT appear correct should be inspected using the information in the preceding pages of this specification and in the instructional material shipped with the product or tooling.

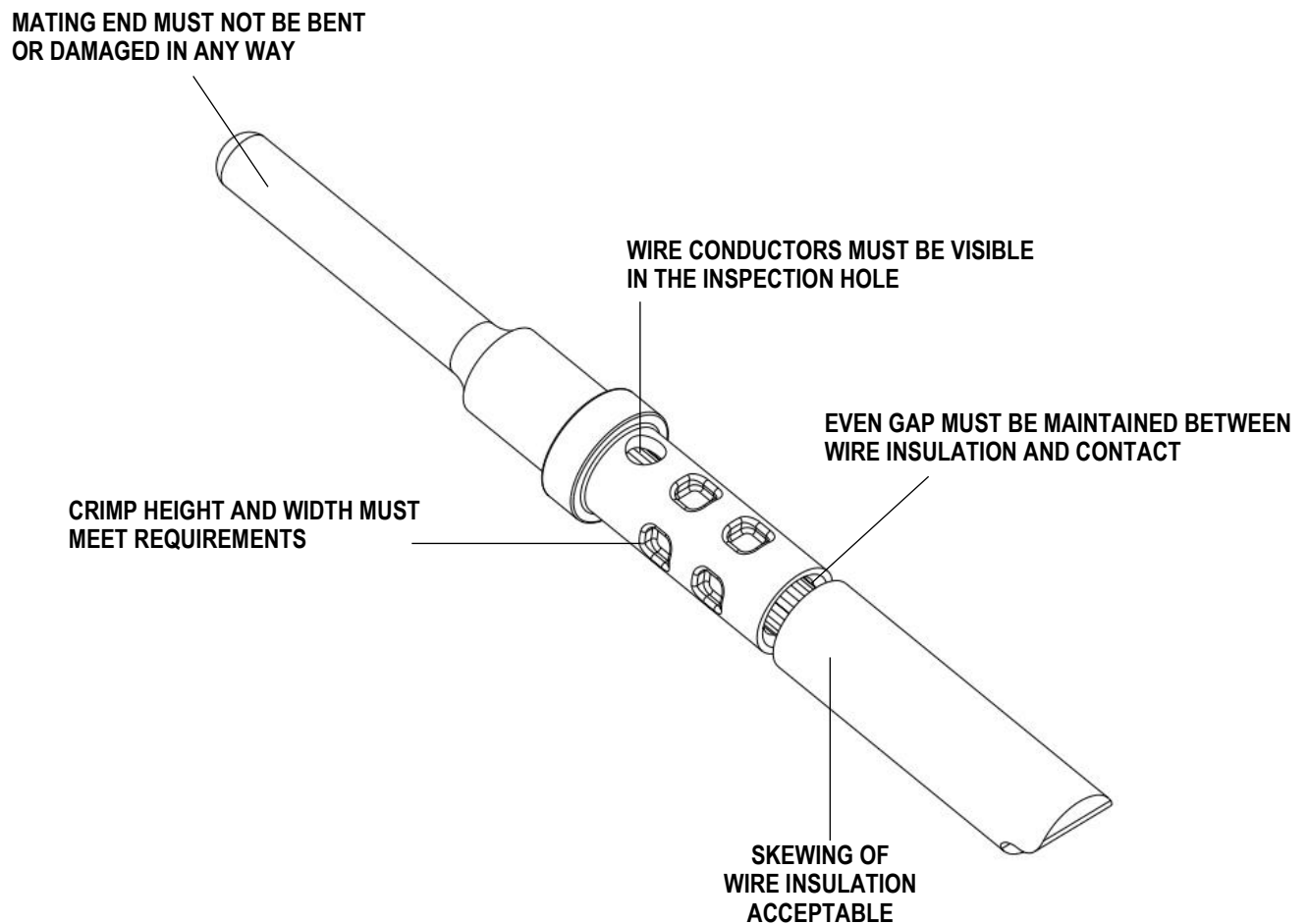

FIGURE 6. VISUAL AID

7. REVISION HISTORY

Rev Ltr	Brief Description of Change	Date	Drawn	Approved
A	Initial Release	04-OCT-18	KP	DM
A1	Updated Crimp Tensile and Gauge details for 0460-256-12XX	26-Nov-18	KP	DM
B	1)Page3, 2.4 Added 108-151004 with hyperlink 2) Page9, Updated Table, Updated Crimp Tensile value for Size 16 contact 20AWG Wire and Updated Wire size for Size 20 Contacts	24-Jan-19	AK	DM
B1	1) Page 9, Updated Crimp height column in Table	7-Mar-19	AK	DM
B2	Page 4. Section 3.4. First sentence should read: <i>The contacts accept stranded wire sizes and insulation diameters using wire standards in Section 2.5.</i>	26-Mar-20	DM	DM
C	1) Page 8, Add M22520/7-01 Hand Tool with M22520/7-02 & M22520/7-03 Positional to support 24 AWG wire size. Additional wire sizes information added to hand crimp tool. 2) Page 9, Remove 10mm ² from size 8 contacts	20-Aug-20	CL	IG
D	1) Page 8, Correction M22520/7 Hand crimp tool. 2) Page 9, Update table. Added new 22-24AWG crimp die and gauge, 2 new Size 16 part number. Remove 1.5mm ² wire gauges for Size 20. 3) Page 10, Added note 4. (IS) Metric wire sizes are for references only. (All contacts were validated with AWG wires.) 4) Page 10, Added note 5. (IS) Metric conversion based on AWG wire dimensions. 5) Page 10, Added comment K & L.	27-OCT-20	CL	IG
E	1) Page 8, Removed Hand Crimping Tool HDT-1561. 2) Page 9, Added HDT-48-00 crimp height table with header. 3) Page 10, Added header "Table is specific to HDP-400" to table. 4) Page 10, Fixed Crimp Tensile lbf rating equivalent to 45 N for size 16 and 20 contacts in HDP-400 table. 5) Page 11, Added note 6. Crimp heights are for reference only. Use tensile strength for crimp validation. 6) Page 10, Expanded comment A to include 0462-203-12XX. 7) Page 10, Expanded comment B to include 0462-210-12XX.	13-SEP-22	AS	IG
E1	1) Page 1, Correction to revision number on document header.	14-SEP-22	CL	IG