



**NOTE**

All numerical values are in metric units [with U.S. customary units in brackets]. Dimensions are in millimeters [and inches]. Unless otherwise specified, dimensions have a tolerance of  $\pm 0.13$  [ $\pm .005$ ] and angles have a tolerance of  $\pm 2^\circ$ . Figures and illustrations are for identification only and are not drawn to scale.

**1. INTRODUCTION**

This specification covers the requirements for application of DEUTSCH DTM series connector system. The system features a plug and receptacle that offers 2, 3, 4, 6, 8, and 12-pin arrangements which accept DEUTSCH size 20 solid (machined) or stamped & formed contacts.

The plug and receptacle each consist of a housing and secondary wedge lock. The secondary wedge lock is used to ensure that the contact is fully seated and secure in the connector. The connector and the secondary wedge lock are shipped separately. These connectors feature integral keying and latch-style mating. The 8 and 12-pin arrangement housings are color-coded to correspond with the keying letter.

Basic terms and features of this product are provided below. Pages 2 through 4 provide examples of additional features and modifications.

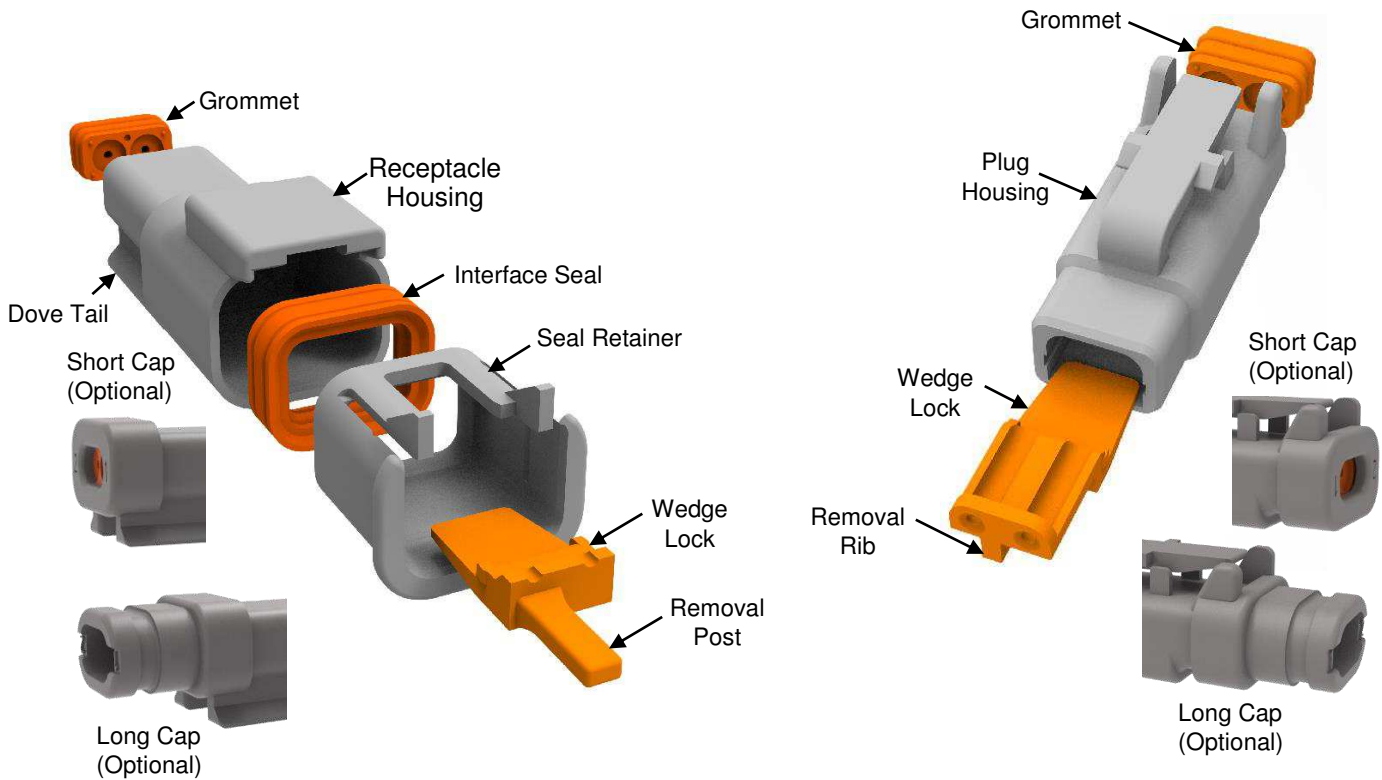

Standard Features All Arrangements  
(2-pin example)

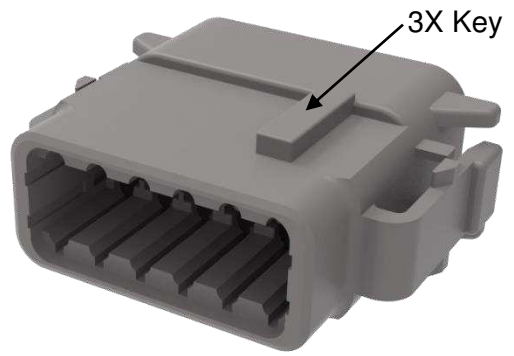
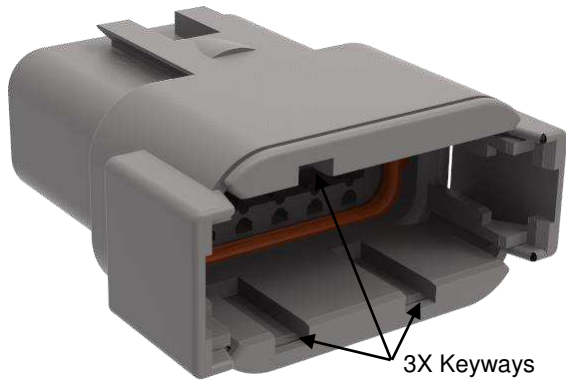

8 & 12pin Features  
(12pin example)



A Key  
(Grey)



B Key  
(Black)



C Key  
(Green)

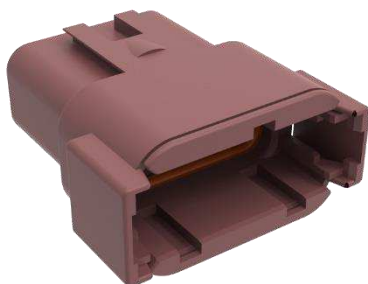
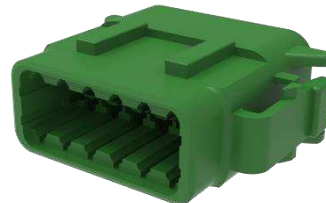

D Key  
(Brown)



### 1.1. Receptacle

2 to 6-pin



8 and 12-pin  
(A Key)

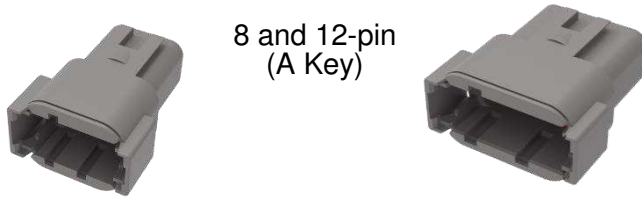

Receptacles, No Cap, Gray and Black

2 to 6-pin



8 and 12-pin  
(A Key)

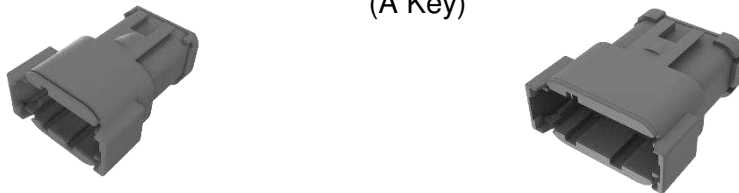

Receptacles, Short Cap, Gray and Black

2 and 3-pin



Receptacles, Long Cap, Gray and Black



Receptacles, Flange, No Cap, 3-pin

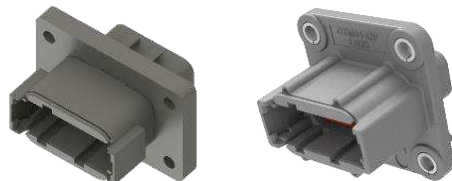

Receptacles, Flange, No Cap, 12-pin

## 1.2. Plug

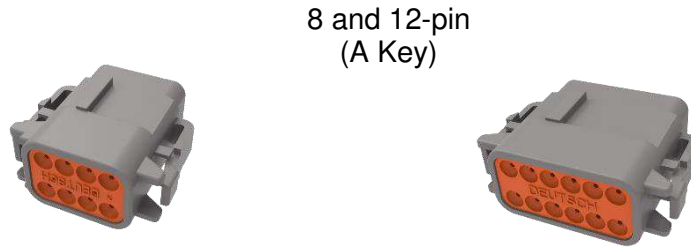

Plugs, No Cap, Gray and Black

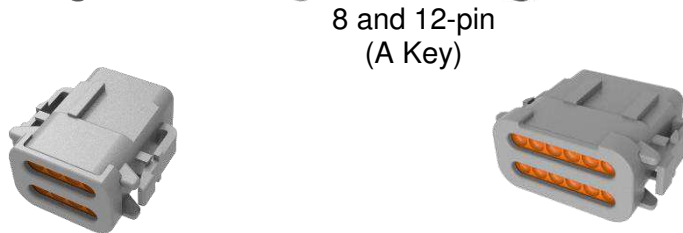
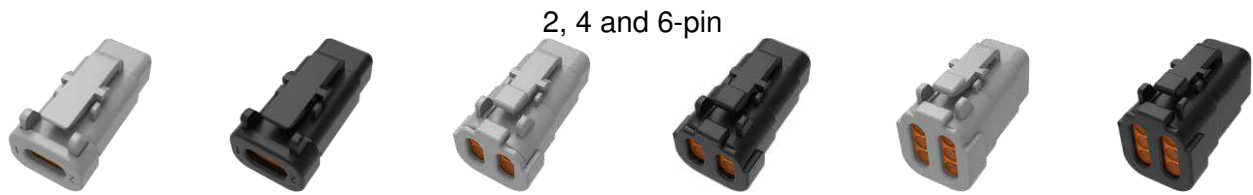

Plugs, Short Cap, Gray and Black

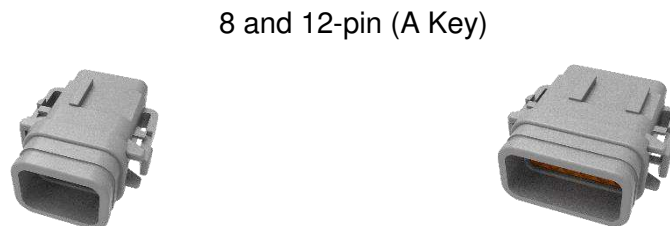

Plugs, Long Cap, Gray and Black

**1.3. Product Dimensions**

See connector and wedge product drawing for product dimensions. See section 2.3

**2. REFERENCE MATERIAL**

**2.1. Revision Summary**

See section 8.

**2.2. Customer Assistance**

Reference Product Base Part Numbers DTM04-2P, DTM04-3P, DTM04-4P, DTM04-6P, DTM04-08PX, DTM04-12PX (receptacles), and DTM06-2S, DTM06-3S, DTM06-4S, DTM06-6S, DTM06-08SX, DTM06-12SX (plugs) (X = A to D keys) and Product Code EQ64 are representative of DEUTSCH DTM series connector system. Use of these numbers will identify the product line and help you to obtain product and tooling information when visiting [www.te.com](http://www.te.com) or calling the number at the bottom of page 1.

**2.3. Drawings**

Customer drawings for product part numbers are available from [www.te.com](http://www.te.com). Information contained in the customer drawing takes priority. X refers to A, B, C, D keys; XXXX refers to product modification.

**CONNECTORS**

Product Drawing	Description
DTM04-2P-XXXX	2 Pin Receptacle
DTM04-3P-XXXX	3 Pin Receptacle
DTM04-4P-XXXX	4 Pin Receptacle
DTM04-6P-XXXX	6 Pin Receptacle
DTM04-08PX-XXXX	8 Pin Receptacle
DTM04-12PX-XXXX	12 Pin Receptacle

Product Drawing	Description
DTM06-2S-XXXX	2 Pin Plug
DTM06-3S-XXXX	3 Pin Plug
DTM06-4S-XXXX	4 Pin Plug
DTM06-6S-XXXX	6 Pin Plug
DTM06-08SX-XXXX	8 Pin Plug
DTM06-12SX-XXXX	12 Pin Plug

**WEDGE**

Product Drawing	Description
WM-2PX	2 pin Rcpt Wedge Lock
WM-3P	3 pin Rcpt Wedge Lock
WM-4P	4 pin Rcpt Wedge Lock
WM-6P	6 pin Rcpt Wedge Lock
WM-8P	8 pin Rcpt Wedge Lock
WM-12P-XXXX	12 pin Rcpt Wedge Lock

Product Drawing	Description
WM-2SX	2 pin Plug Wedge Lock
WM-3S	3 pin Plug Wedge Lock
WM-4S	4 pin Plug Wedge Lock
WM-6S	6 pin Plug Wedge Lock
WM-8S	8 pin Plug Wedge Lock
WM-12S-XXXX	12 pin Plug Wedge Lock

**2.4. Specifications**

- [108-151000](#) Product Specification for DEUTSCH Stamped and Formed Contacts
- [108-151004](#) Product Specification for DEUTSCH Solid Contacts
- [108-151010](#) Product Specification DTM Series
- [114-151003](#) Application Specification for DEUTSCH Size 20 S&F Pin and Socket Contacts
- [114-151004](#) Application Specification for DEUTSCH size 4-20 Solid Pin & Socket

## 2.5. Instructional Material

Instruction sheets (408-series) provide product assembly instructions or tooling setup, and operation procedures and customer manuals (409-series) provide machine setup and operating procedures. Instructional material that pertain to this product are:

[408-151008](#) DEUTSCH Removal Tool DT-RT1 for Front-Release Connectors.

## 3. REQUIREMENTS

### 3.1. Safety

Do not stack product shipping containers so high that the containers buckle or deform.

### 3.2. Storage

#### A. Ultraviolet Light

Prolonged exposure to ultraviolet light may deteriorate the chemical composition used in the product material.

#### B. Shelf Life

The product should remain in the shipping containers until ready for use to prevent deformation to components. The product should be used on a first in, first out basis to avoid storage deterioration could adversely affect performance.

#### C. Chemical Exposure

Do not store product near any chemical listed below as they may cause stress corrosion cracking in the material.

Alkalis	Ammonia	Citrates	Phosphates	Sulfur Compounds	
Acids	Amines	Carbonates	Nitrites	Sulfur Nitrites	Tartrates



NOTE:

1) Resistance depends on chemical concentration, temperature, and exposure medium.

### 3.3. Characteristics

#### A. Part Numbering System

##### CONNECTOR

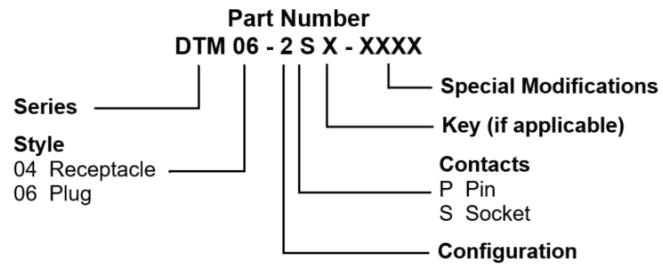

##### WEDGE

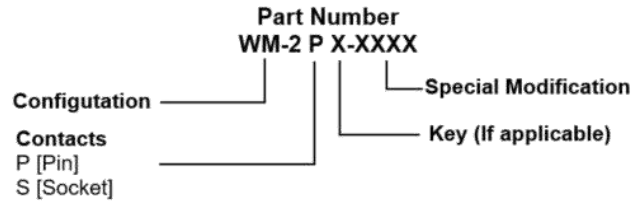

**i** *Note:*  
Pins used in receptacle Sockets used in plug.

#### B. Pin Arrangement

See product drawing for contact cavity marking

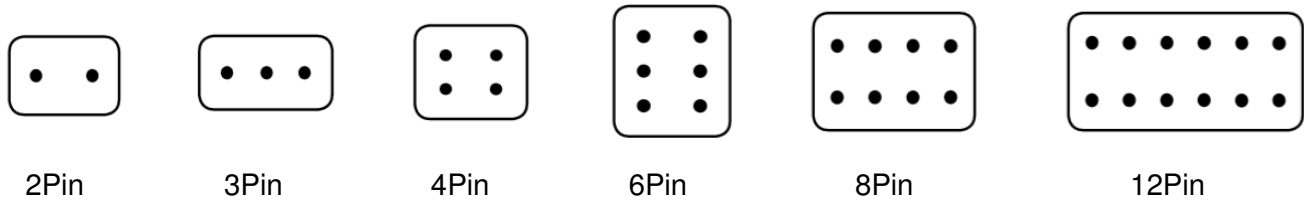

#### C. Materials

- Receptacle and Plug Housings: PA66 GF15 (gray, black, green, or brown)
- Caps: PA66 GF15 (gray, black, green, or brown)
- Flanges: PA66 GF15 (gray or black)
- Wedge Locks: PBT GF30 (Orange, Green, Red, Gray, Black)
- Interface Seals: VMQ (red-orange)
- Grommets: VMQ (red-orange)
- Compression Limiter: Steel Zinc Plated

## D. Wedge Locks

### Receptacle Wedge Locks

PN	Description	Shape and Color	
WM-2P	Wedglock for 2 pin Receptacle		Orange
WM-2PA	Wedglock for 2 pin Receptacle "A" key		Grey
WM-2PB	Wedglock for 2 pin Receptacle "B" key		Black
WM-3P	Wedglock for 3 pin Receptacle		Orange
WM-4P	Wedglock for 4 pin Receptacle		Orange
WM-6P	Wedglock for 6 pin Receptacle		Orange
WM-8P	Wedglock for 8 pin Receptacle		Orange
WM-12P	Wedglock for 12 pin Receptacle		Orange
WM-12P-P073	Wedglock for 12 pin Receptacle		Red



### Plug Wedge Locks

PN	Description	Shape and Color	
WM-2S	Wedgeloock for 2 pin Plug		Orange
WM-2SA	Wedgeloock for 2 pin Plug "A" key		Grey
WM-2SB	Wedgeloock for 2 pin Plug "B" key		Black
WM-3S	Wedgeloock for 3 pin Plug		Orange
WM-4S	Wedgeloock for 4 pin Plug		Orange
WM-6S	Wedgeloock for 6 pin Plug		Orange
WM-8S	Wedgeloock for 8 pin Plug		Orange
WM-12S	Wedgeloock for 12 pin Plug		Orange
WM-12S-P073	Wedgeloock for 12 pin Plug "P073"		Red
WM-12S-B026	Wedgeloock for 12 pin Plug "B026"		Green

### E. Sealing Range

Conductor Range	Insulation OD Sealing Range in [mm]	Seal Type
16 - 20 AWG [1.0 - 0.5 mm <sup>2</sup> ]	.053 - .120 [1.35 – 3.05]	N-Seal

### F. Sealing Plugs

Open cavities provide pathways for contaminants to enter the connectors. To maintain seal integrity, any unused cavity must be filled with the appropriate size sealing plug.

Part Number	Material	Color	Description	Sealing Plug
0413-204-2005	PBT	Red	Sealing Plug	

### G. Keying Pins

Keying pins are solid plastic rods used to prevent mis-mating of like connectors in close proximity. Keying pins are inserted into the retention fingers of an empty socket cavity. Once installed, the keying pin blocks a mating contact pin from being inserted. The contact pin will be blocked before the latch device mates the connectors, helping to prevent the mis-mating of like connectors. Proper usage requires that the corresponding mating pin to be omitted and a sealing plug be inserted in the rear cavity of the mating connector. Individual applications will vary, and testing should be done to determine the best arrangement to help prevent improper connector mating.

Part Number	Material	Color	Description	Sealing Plug
0413-216-2005	PBT	Red	Keying Pin	



NOTE:

- 1) Multiple keying pins may be required to help prevent unintentional forced mating.

**H. Modification**













NOTES:

- 1) Modifications include but are not limited to the following list.
- 2) Modifications listed are for reference only and may not be available for every arrangement.

Mod	Description
B026	Wedge (plug) to use with DTMF15-48P-B026
C017	Solid rear grommet, Short Cap
C035	Cavity number two blocked (2 Position only).
E003	Short cap
E004	Black Housing
E005	Black, short cap
E007	Long cap
E018	High temp, Gray, Black, Green, Brown High temperature (150°)
EE03	Long cap, black
EE04	High temperature (150°), Black
EE08	High temperature (150°)
L012	Flange
L025	Integrated flange receptacle with compression limiters
P073	Wedge, Glow Wire, V-0

## Common Modifications

Modification	Description	Plug	Receptacle
C017	Solid rear grommet		
E003	Includes a protective end cap attached to the rear of the connector. There are holes or slots in the cap to allow the contacts to be inserted. Color: grey		
E004	Changes the connector body color to black		
E005	Includes a protective end cap attached to the rear of the connector. There are holes or slots in the cap to allow the contacts to be inserted. Color: black		
E007	Includes an extended cap to attach shrink tubing where application requirements need extra wire protection. Color: Gray		
EE03	Includes an extended cap to attach shrink tubing where application requirements need extra wire protection. Color: Black		
L012	Includes a simple welded-on flange onto receptacle to simplify wire routing and assembly.		
L025	Receptacle includes integrated flange with compression limiters and O-ring seal.		

## I. Accessories

Several accessory items can be used to complement the connectors such as PVC boots, plastic backshells, neoprene closed cell gaskets, protective dust caps and mounting clips. Accessories are designed to complete the application and meet a wide array of design requirements such as solutions for mounting, providing additional protection, and offering increased aesthetics.

### BOOTS

Slip-on boots are not only aesthetically appealing, but also provide increased protection from dirt, paint overspray and pressure washing.

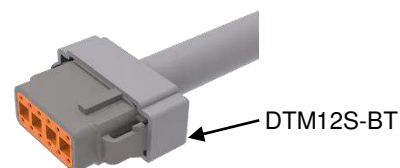
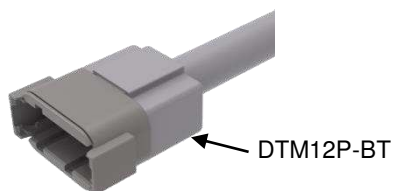

Part Number Receptacle	Description
DTM2P-BT	2way, Gray
DTM2P-BT-BK	2way, Black
DTM3P-BT	3way, Gray
DTM3P-BT-BK	3way, Black
DTM4P-BT	4way, Gray
DTM4P-BT-BK	4way, Black
DTM6P-BT	6way, Gray
DTM8P-BT	8way, Gray
DTM8P-BT-BK	8way, Black
DTM12P-BT	12way, Gray
DTM12P-BT-BK	12way, Black

Part Number Plug	Description
DTM2S-BT	2way, Gray
DTM2S-BT-BK	2way, Black
DTM3S-BT	3way, Gray
DTM3S-BT-BK	3way, Black
DTM4S-BT	4way, Gray
DTM4S-BT-BK	4way, Black
DTM6S-BT	6way, Gray
DTM8S-BT	8way, Gray
DTM8S-BT-BK	8way, Black
DTM12S-BT	12way, Gray
DTM12S-BT-BK	12way, Black

Material: PCV

Operating temperature is -29°C to +100°C [-20° to +212°F].



NOTE:

- Boots are received with the end closed. Cut end of boot off to desired length.

### PROTECTIVE DUST CAPS

Slip-on PVC boots provide protection from dirt, paint overspray and pressure washing.



Part Number Rubber Dust Cap	Description	Connector Part Number
DTM3S-DC	3pin, Gray, Receptacle	DTM06-3S
DTM12P-DC	12pin, Gray, Receptacle	DTM04-12PX
2289860-1 (DTM8P-DC-L025)	8pin, Gray, Receptacle	YDTM04-08PX-L025

Material: PVC  
 Operating temperature is -29°C to +100°C [-20° to +212°F]

## BACKSHELLS

Designed to snap onto and mate with all standard plug and receptacles without modifications that affect the rear of the connector. The rigid, durable backshells offer a high level of protection and allow corrugated tubing to nest within the rear of the backshell. Straight (180°) version and right angle (90°) adapter are available. Since the backshells are designed to work with the standard connectors, tests should be conducted for fit and function of a backshell being used on any part with a modification.

1028-021-0205



1028-015-1205



### Receptacle Backshell

Connector Part Number	Corrugated tubing size (mm)	Part Number
DTM04-2P	8	1028-021-0205
DTM04-3P	7.5 & 8.5	1028-024-0305
DTM04-4P	7.5 & 8.5	1028-025-0405
	7.5 & 8.5	1028-026-0405
	7.5 & 8.5	1028-027-0405
DTM04-8P	10	1028-032-0805
DTM06-12P	13 & 17	1028-034-1205

### Plug Backshell

Connector Part Number	Corrugated tubing size (mm)	Part Number
DTM06-2S	7.5 & 8.5	1011-273-0205
	8.5	1028-041-0205
	4.5	1028-044-0205
DTM06-3S	8.5	1028-005-0305
DTM06-4S	8.5	1028-008-0405
DTM06-6S	10 & 13	1028-011-0605
DTM06-8S	10 & 13	1028-013-0805
DTM06-12S	10 & 13	1028-015-1205

### 90° Backshell adapter

### Mating Backshell Part Number

1028-016-0005 (Plug)	1028-041-0205
	1028-005-0305
	1028-008-0405
1028-017-0005 (Receptacle)	1028-011-0605
	1028-013-0805

Material: PA66

Operating temperature is -55°C to +125°C [-67°F to +257°F]

## GASKETS

Moisture, dirt, salt, sand, and road debris can all work their way into electrical panels through unsealed mounting flanges. These rugged high-quality gaskets form a splash proof seal between the panel face and connector flange to help keep out destructive elements. The gaskets have a thickness of .125.



Part Number	Connector Part Number
DT12-L012-GKT	DTM04-12PX-L012 2303064-1 2303064-2

Material: Closed Cell Sponge.  
 Operating temperature: -57°C to +107°C [-70° to +225°F]  
 Gaskets are not IP rated



### MOUNTING CLIPS

Mounting clips are installed on the receptacle to mount the connector. To meet design needs, the clips are available for several configurations and in plastic, stainless steel, or steel with zinc plating.

Part Number	Mounting Direction	Material	Plating Color	Mounting Hole mm [in]	Cavity Arrangement
1027-003-1200	Straight	Stainless Steel	None	11 [.433]	DTM2, 3, 4, 6, 8, 12
1027-005-1200				13 [.512]	
1027-004-1200		Steel	Zinc/Yellow		
1011-026-0205		PA66	Black	5.08 [.200]	
1011-030-0205				T-Stud Mount	
1011-310-0205 <sup>2</sup> 1924484-2		Fir-Tree Mount			
1027-008-1200	Side	Steel	Zinc/Yellow	11 [.433]	
1027-017-1200				8.2 [.323]	



**NOTES:**

- 1) Zinc is RoHS compliant
- 2) Retention force is 89N [20 lbf] except 1011-310-0205 is 50N [11.2 lbf].



Straight Hole Mount

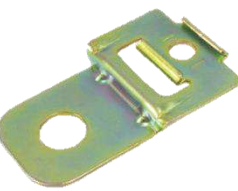

Slide Hole Mount



Hole Mount



T-Stud Mount



Fir-Tree Mount

### 3.4. Contact Insertion

**1. The crimped contact must meet these specifications:**

- 114-151003 Application Specification for DEUTSCH Size 20 S&F Pin and Socket Contacts
- 114-151004 Application Specification for DEUTSCH size 4-20 Solid Pin & Socket

2. Grasp crimped contact approximately 25.4 mm [1.0 in] behind the contact crimp barrel and hold the connector with grommet facing you.
3. Push contact straight into grommet until positive stop is felt. The contact will lock into place. A slight tug on wire will confirm that is properly locked in place.

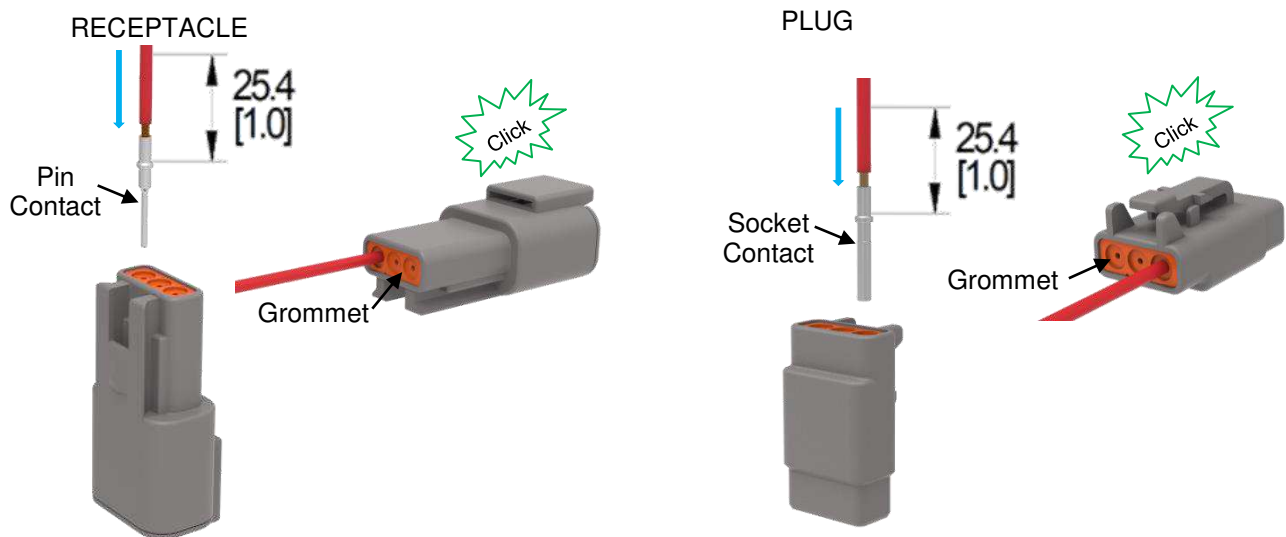

**NOTE:**

- 1) Pins used in receptacle, sockets used in plug.
- 2) Wire insulation outside diameter must meet connector wire sealing range per section 3.3.E.
- 3) Insertion tool, M15570-20 (size 20) may be needed for ≤20 AWG wire.

4. Once all the contacts are in place, insert the wedge lock until it snaps into place. For the receptacle, small long nose pliers may be used to assist in locking into place. For the plug, wedge lock may be locked in place by hand.

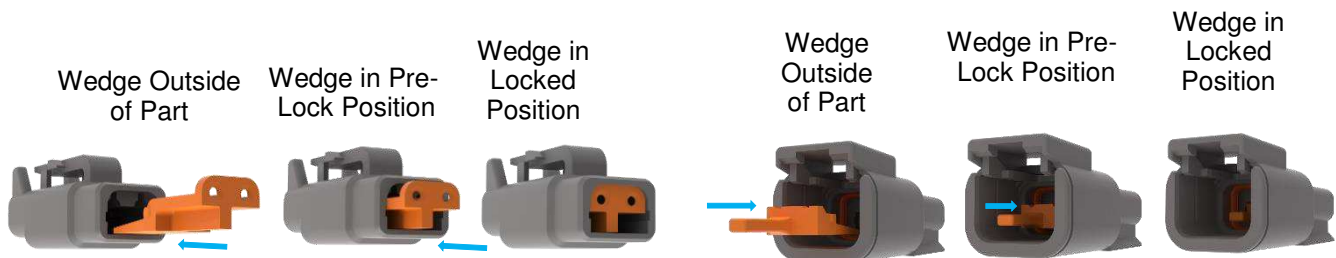

### 3.5. Contact Insertion Tool

Insertion tools are used to help insert small gage wire contacts into connectors that utilize a round shoulder contact retention system. Insertion tools are compact, easy-to-use and made with durable plastic to insert wire contacts without damaging wire, insulation, rear grommet seal or connector housing.

#### USING THE TOOL

1. Insert the wire contact into the colored end wire entry slot and gently pull back until the contact locking shoulder is against tool.
2. Push the tool/wire contact assembly into the connector rear until the contact is felt snap into position within the retainer.
3. While holding the wire forward, gently pull remove tool out.
4. A slight tug on wire will confirm the contact is properly locked in place.

Contact Size	Part Number	Mil-Spec	Color Insertion	Insertion Tool
20	M15570-20	M081969/14-11	Red	



**CAUTION:**

*Do not twist or insert the insertion tool at angle; otherwise, damage to the cavity retention finger(s) will result.*

### 3.6. Contact Removal

DEUTSCH DT-RT1 multi-use tool has a small hook on one end for wedge lock removal and a small screwdriver on the other end to push back the locking fingers and release the contact. The tool is designed to extract individual DEUTSCH solid and stamped and formed (S&F) pin and socket contacts from front-release connectors. See [408-151008](#) for more information.

#### A. Removing Socket Contact

1. Using small long nose pliers, grasp the wedge lock, then pull it straight out of the connector.

**CAUTION:** Be careful not to damage the inner ribs of the wedge lock if it is intended to be re-used.

2. Insert the screwdriver tip of the removal tool into the contact cavity of the contact to be removed to release the locking finger.
3. Pull the wire until the contact is removed. If there is no end cap on the connector, it may be necessary to hold the rear grommet in place with fingers while removing the contact.

#### Removing Socket Contacts

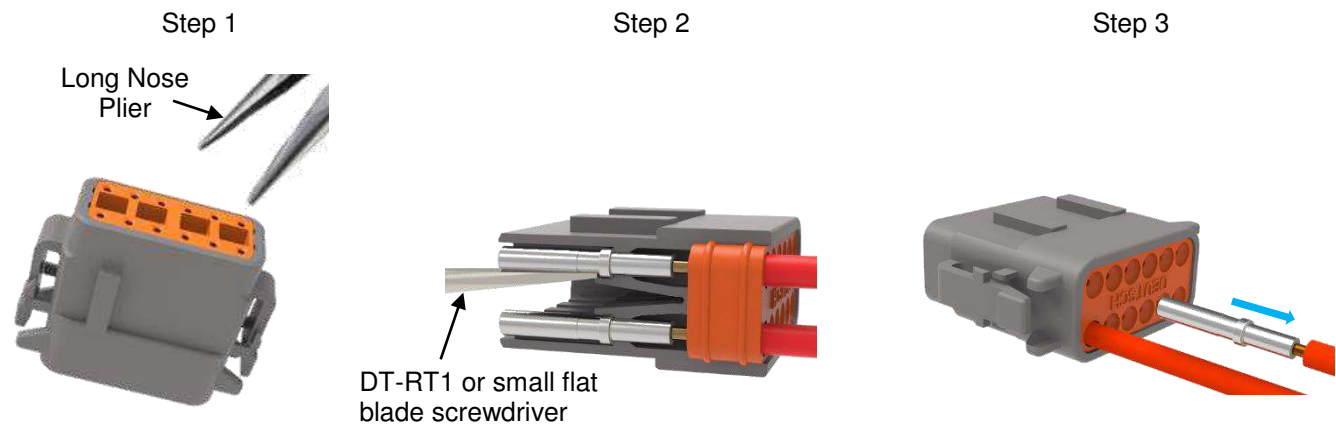

#### B. Removing Pin Contact

1. Using the small long nose pliers, grasp the wedge lock, then pull wedge straight out of the connector.
2. Insert the screwdriver tip of the removal tool into the contact cavity of the contact to be removed to release the locking finger.
3. Pull the wire until the contact is removed. If there is no end cap on the connector, it may be necessary to hold the rear grommet in place with fingers while removing the contact.

#### Removing Pin Contacts

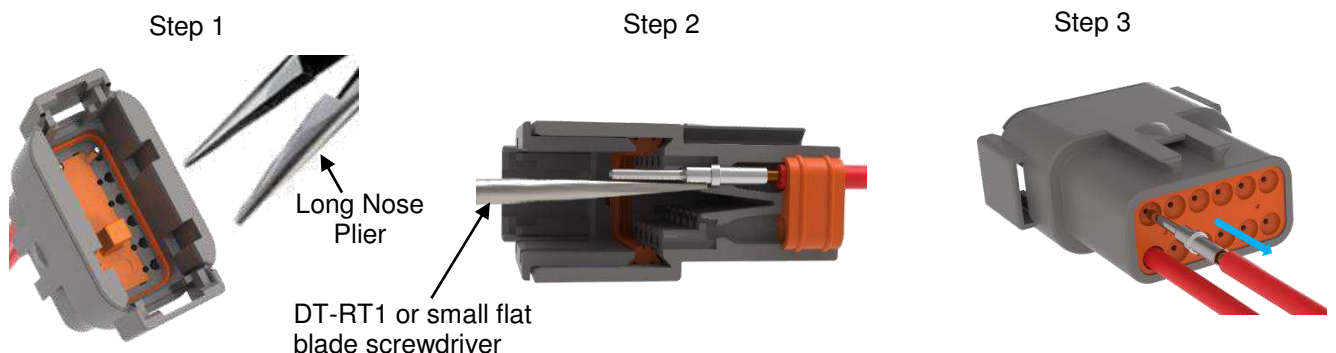

**i** Note: If rear grommet comes out, inspect it for cuts, cracks or other damage. Replace if necessary. Reinstall

### 3.7. Sealing Plug and Keying Pin Installation and Removal.

#### Sealing Plug

Step 1:

Holding the sealing plug with large diameter end away from the connector, gently apply downward pressure to force the sealing plug into the cavity.

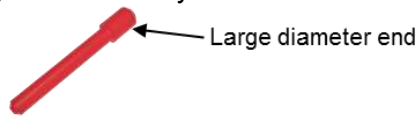

Step 2:

With perpendicular motion, apply downward pressure to the large diameter end of the sealing plug.

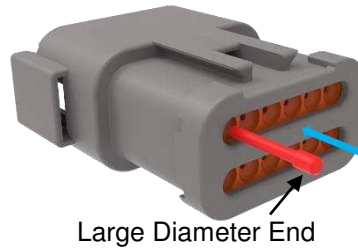
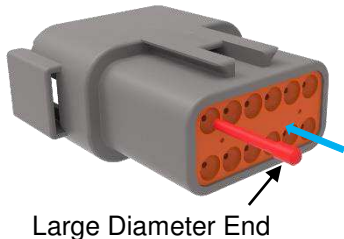

**Note:**  
The large diameter end must be flush with cavity opening. Do not push all the way through.

Step 3:

Apply pressure until sealing plug is forced to stop by contact with rear grommet. Visually inspect the sealing plug large diameter end to confirm it is flush with cavity opening. Do not push all the way through. Maximum allowable distance from top of sealing plug to grommet surface is 5.60 [.220], maximum allowable distance from top of sealing plug to short cap surface is 4.31 [.170].

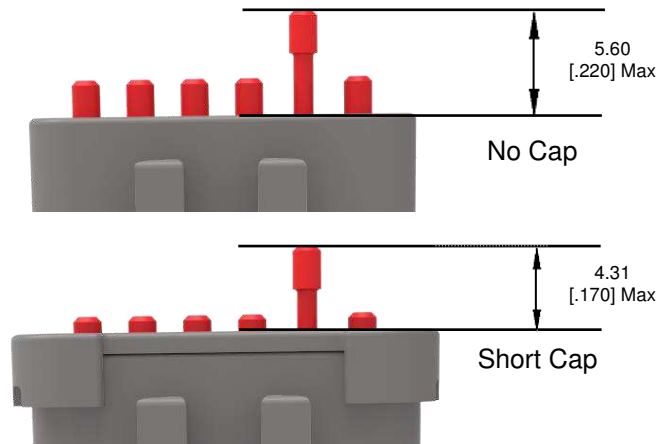

**Note:**  
Sealing plug may be used with long caps but may be difficult to remove.



Step 4:

To remove sealing plug from connector, grasp the large diameter end with fingers or small long nose pliers and pull until sealing plug is removed. If there is no end cap on the connector, it may be necessary to hold the rear grommet in place with fingers while removing the sealing plug.



**Note:**  
If rear grommet comes out, inspect it for cuts, cracks or other damage. Replace if necessary. Reinstall

## Keying Pin

### Step 1:

Holding the keying pin with large diameter end towards the connector, gently apply downward pressure to force the sealing plug into the cavity.

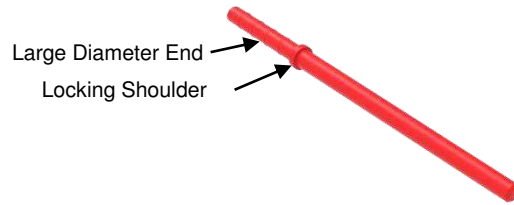

### Step 2:

With perpendicular motion, gently apply downward pressure to the small diameter end of the Keying Pin.

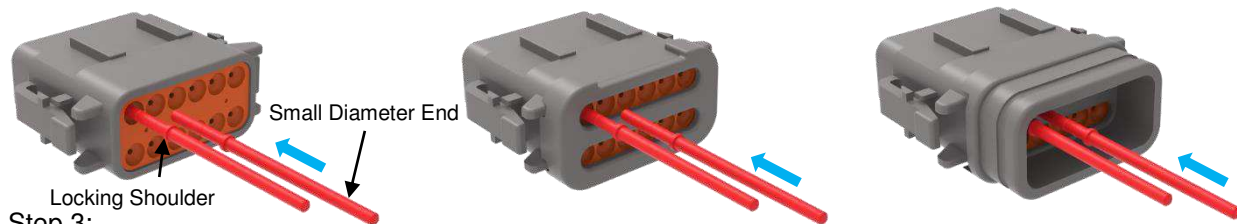

### Step 3:

Apply pressure until sealing plug locks into place. A slight tug on the sealing plug will confirm it is locked into place. Allowable distance from top of sealing plug to connector surface is shown below.

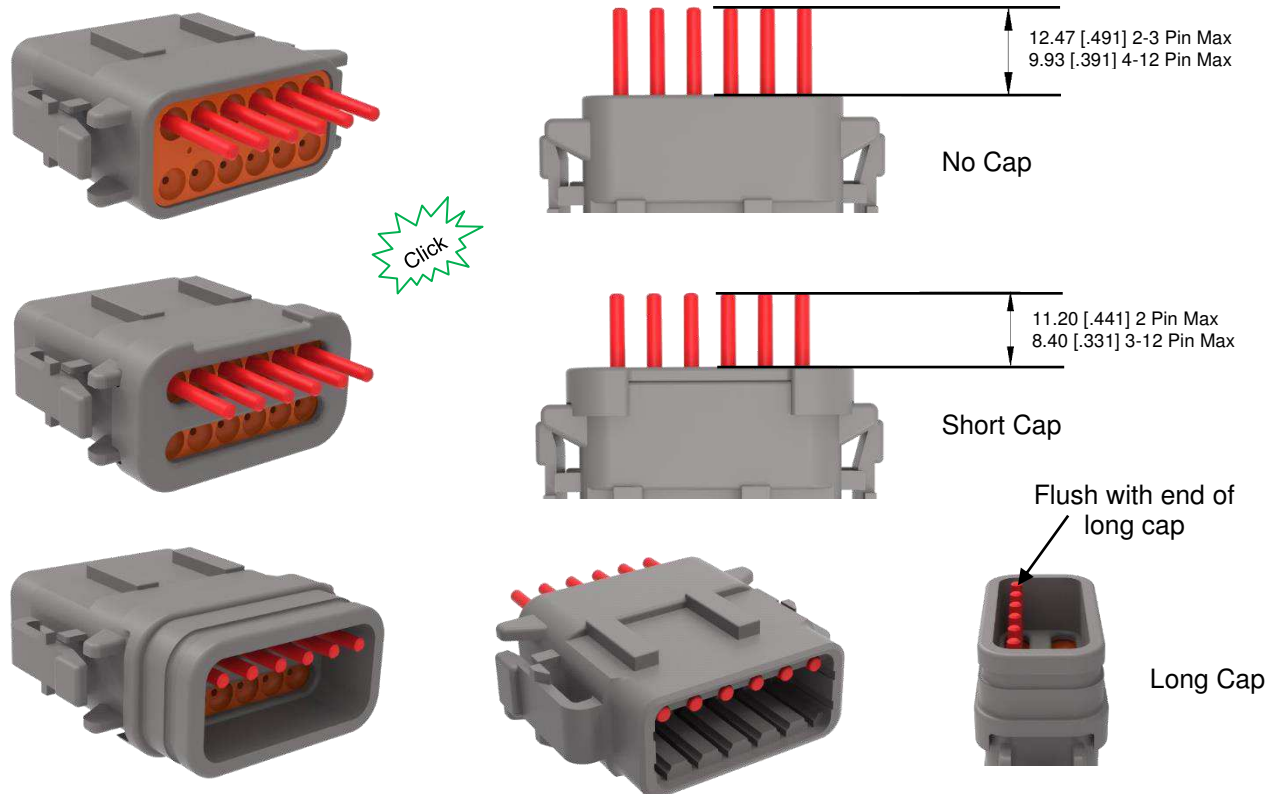

### Step 4:

To remove keying pin from connector, first release the locking finger similar to step 2 of contact removal. Then, grasp the end of the keying pin with fingers or small long nose pliers and pull until it is removed. If there is no end cap on the connector, it may be necessary to hold the rear seal grommet in place with fingers during removal.



Note:

If rear grommet comes out, inspect it for cuts, cracks or other damage. Replace if necessary. Reinstall

### 3.8. Connector Mating

2,3,4,6-pin: To mate the plug and receptacle align the plug latch with the receptacle latch box. Then push plug into the receptacle until there is an audible and tactile click. Verify plug latch is in full latched position.

8 and 12-pin: To mate the plug and receptacle, first make sure both plug, and receptacle are the same key (i.e. A,B,C,D) next align the plug keys with the receptacle keyways. Then push plug into the receptacle until there is an audible and tactile click. Verify both plug latches are in full latched position.

#### 2, 3, 4, 6-Pin

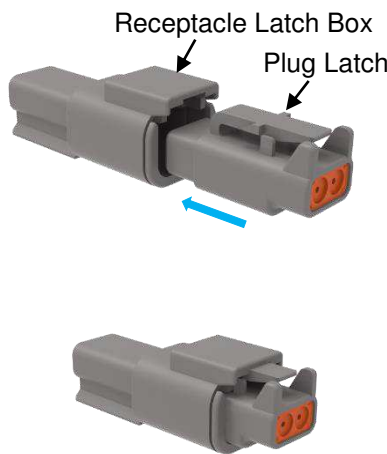

#### 8, 12-Pin

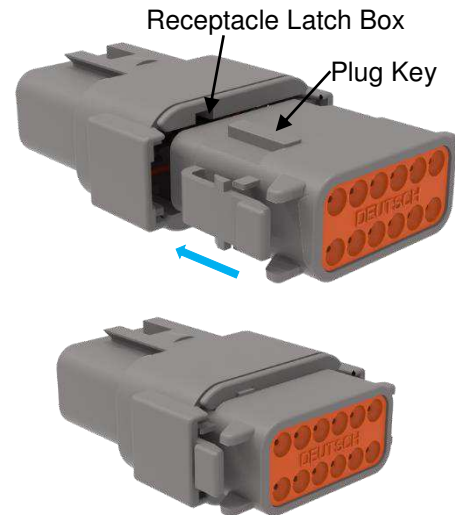

### 3.9. Connector Unmating

To un-mate the plug from the receptacle, push the plug latch(es) until a hard stop is felt. Pull the plug from the receptacle until they are fully separated.

#### 2, 3, 4, 6-Pin

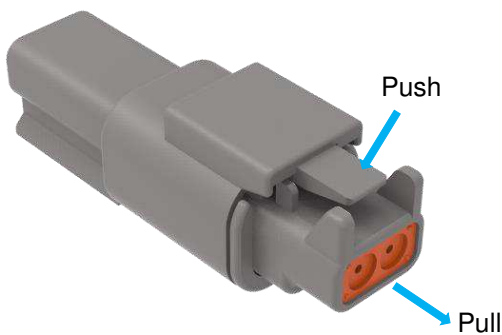

#### 8, 12-Pin

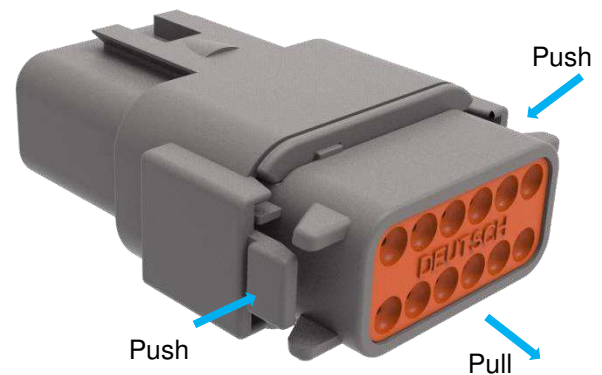

### 3.10. Backshell, Boot, Gasket, Protective Dust Cap, Mounting Clip Installation and Removal

See section I for part numbers.

#### BACKSHELL - PLUG

1. To install the backshell, it must first be in the open position as shown. Slide the half of the backshell with the tall snaps onto the back of the plug.

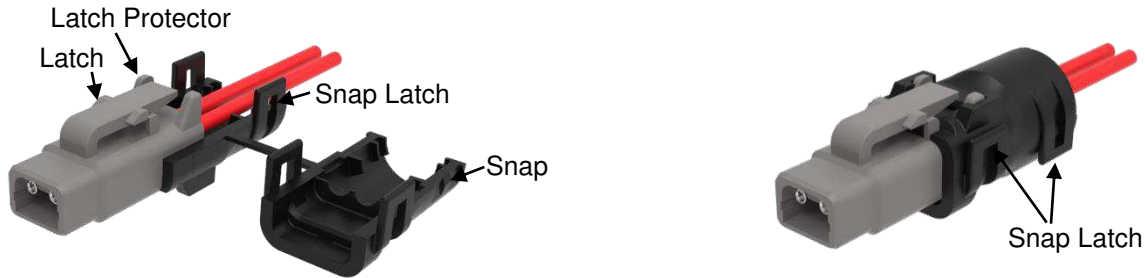

2. To close the backshell, rotate the other half onto the back of the plug while bringing the two halves together. Before snapping shut, make sure convoluted tubing (if used) is captured within the inner grooves. If no convoluted tubing is used, make sure no wires are pinched in the backshell. There are four snaps that need to engage in order to properly snap shut the backshell.

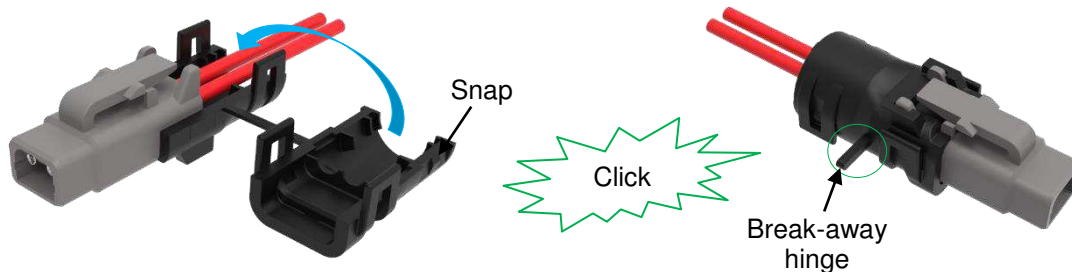

**i** Note: Backshells are equipped with a break-away hinge. After backshell is closed onto the plug, the hinge may be broken off and discarded.

3. To open the backshell, disengage all snaps by wedging a DT-RT1 tool or small flat head screwdriver under the snap latch, lift until disengaged, then pry the backshell open. Backshell can then be slid off of the plug.

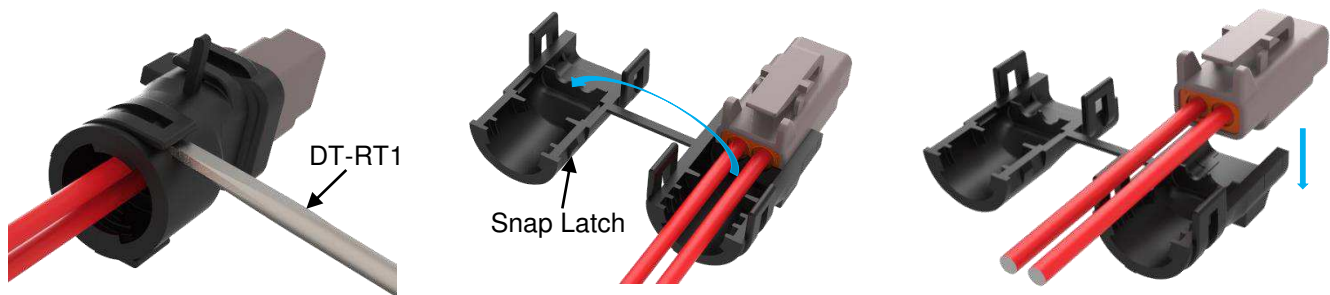

**!** Caution: Be careful not to break the snap latch.



## BACKSHELL - RECEPTACLE

1. To install the backshell, it must first be in the open position as shown. Align the mounting feature of the backshell with the mounting feature of the receptacle. Push backshell straight onto the back of the connector until a positive stop and a snap is felt. A slight tug will confirm that the backshell is properly locked in place.

Snap Latches

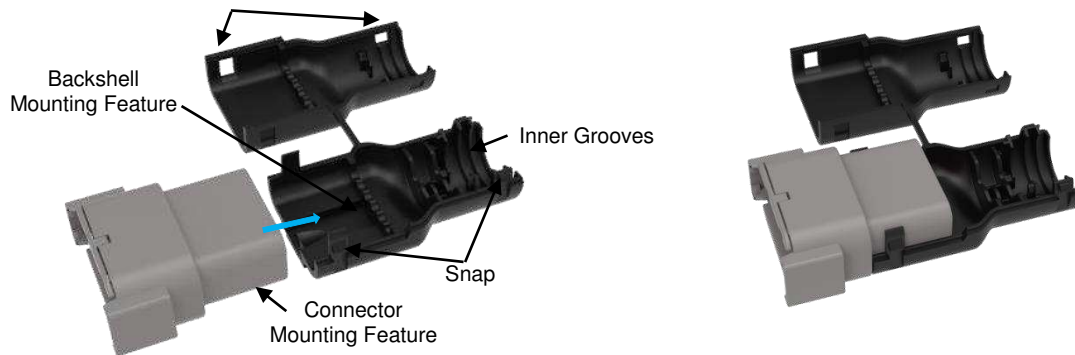

2. To close the backshell, rotate the other half onto the back of the receptacle while bringing the two halves together. Before snapping shut, make sure convoluted tubing (if used) is captured within the inner grooves. If no convoluted tubing is used, make sure no wires are pinched by the backshell. There are four snaps that need to engage in order to properly snap shut the backshell.



3. To open the receptacle backshell, disengage the snap latches by wedging a [DT-RT1](#) tool or small flat head screwdriver under the snap latch, lift until disengaged then pry the backshell open.

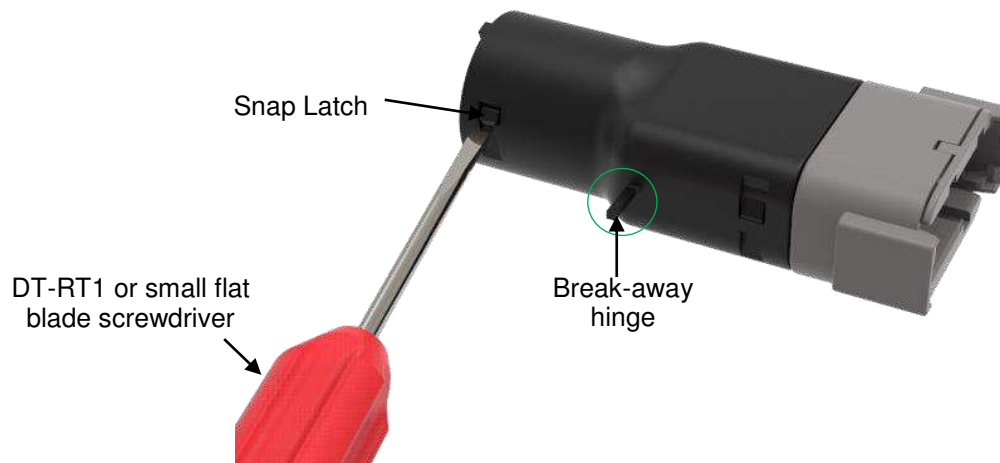

## BACKSHELL TIE WRAP GUIDANCE

### Backshell

- 1) Place the backshell on the connector and attach the wire with a zip tie. The maximum tightening strength is 135N.



- 2) Then close the backshell. The four clips must be locked.

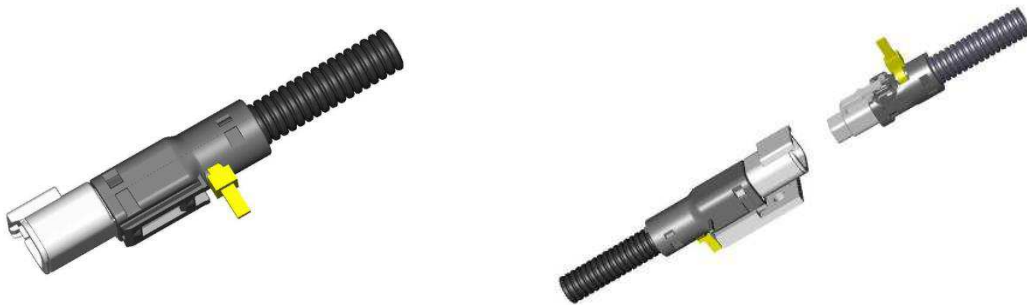

**Note:**

Receptacle backshell is not removable.

Backshells are equipped with a break-away hinge. After backshell is closed onto the receptacle, the hinge may be broken off and discarded.

## BOOT

Step 1. Cutoff the end of the boot to desired length.

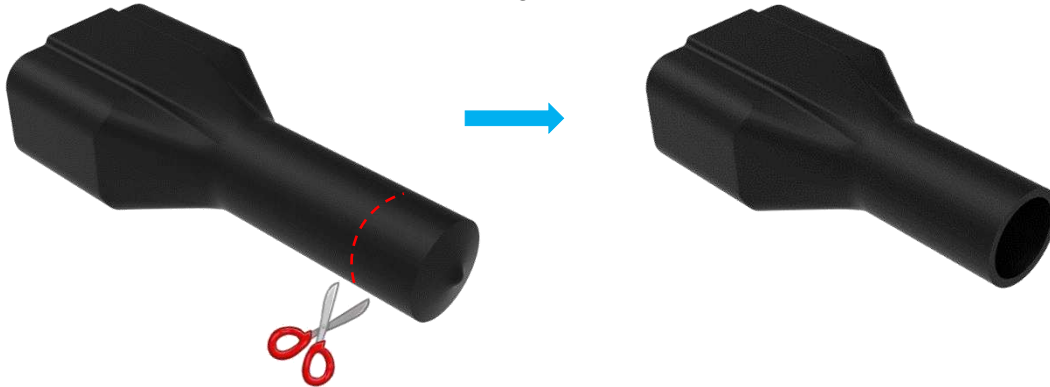

Step 2. Slide the boot over the wires.

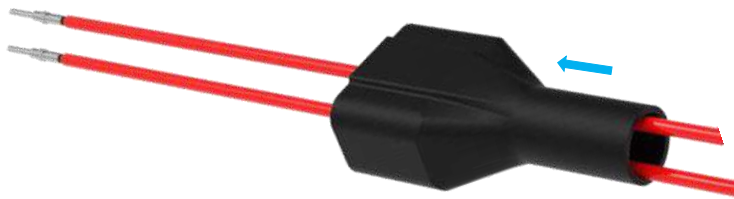

Step 3. Insert the wires into the connector.

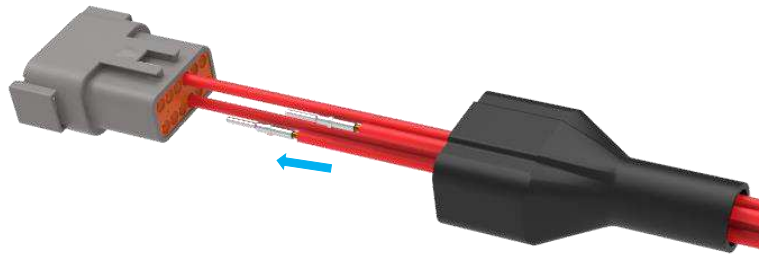

Step 4. Slide boot down the wires and onto the connector.

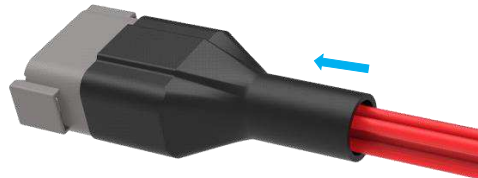

Step 5. If needed, attach a tie wrap on the end of the connector and boot. Trim tie wrap as needed.

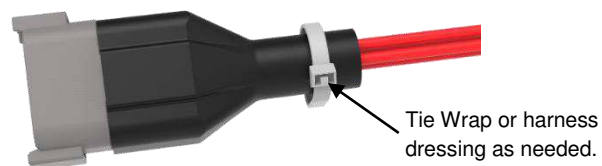

Note:

*Do not put excessive stress on the boot to prevent boot from coming off connector.*

## GASKET

Install the gasket onto the connector on the desired side of the flange. Install on the front side for rear mount, on the back side for front mount. Next, install the connector with gasket into panel mounting hole. See section 3.11 for panel installation.



## PROTECTIVE DUST CAP

Install the protective dust cap onto the front of the connector by aligning the latch box of the receptacle or the plug latch with the latch box or latch opening on the dust cap.

Next, slide the dust cap onto the connector until a stop is felt.

Remove the dust cap by sliding it off the connector.

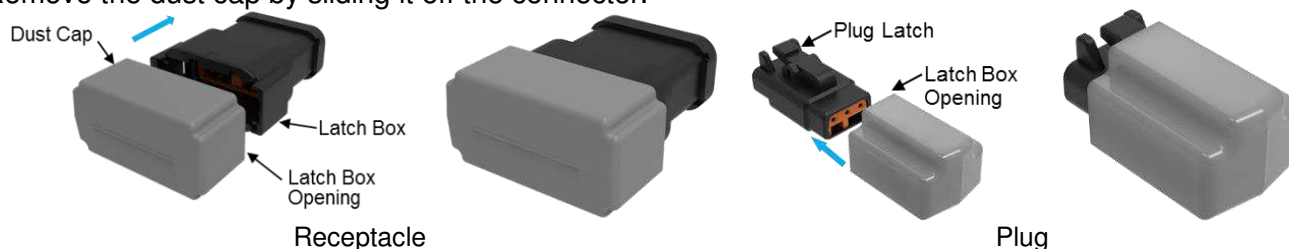

## MOUNTING CLIP - RECEPTACLE

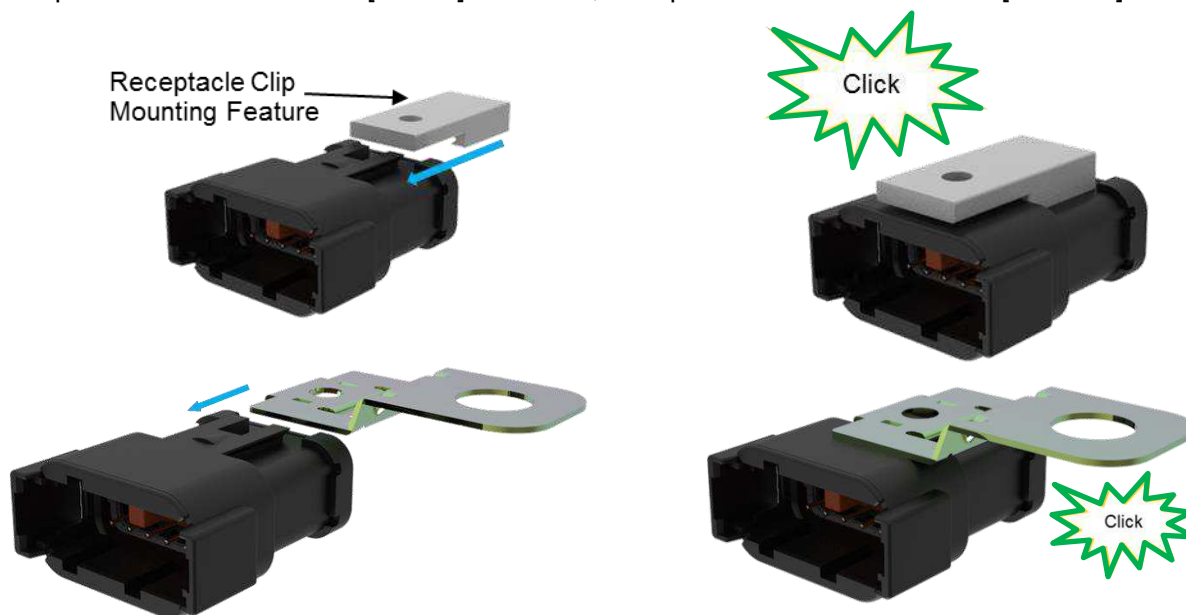

- To install a clip onto a receptacle, first align the clip mounting features of the housing with the clip. Then push the clip straight onto the back of the connector until a positive stop and a snap is felt. Clip retention force is 89N [20 Lbf] minimum, except 1011-310-0205 is 50N [11.2 Lbf] minimum.



**Note:**  
Mounting clip is removable. Damage to receptacle retention feature may occur.

### 3.11. Panel Installation

Receptacles with flanges may be mounted to a panel as shown. Refer to product drawings for panel cutout information. Recommended panel surface roughness is RMS 0.8 $\mu$ m [32 $\mu$ in] or better.

Modification	Description	Receptacle
L012	Includes a simple welded-on flange onto receptacle to simplify wire routing and assembly.	
L025	Includes an integrated flange into the receptacle with compression limiters.	

#### FLANGE – L012 TYPE

Insert wire side of receptacle through the panel cutout for front mount or insert mating side of receptacle through the panel cutout for rear mount. If a gasket is used, ensure the gasket is installed onto the desired side of the flange before inserting connector through the panel cutout.

Recommended screw size is M4 [6-32]. Screw length dependent on application. Recommended screw torque is 2.26-2.82 Nm [20-25 in-lb.]. Recommended mounting hardware (i.e. flat washers, nuts, screws) are customer supplied. Maximum recommended panel thickness is 6.35 [.250].

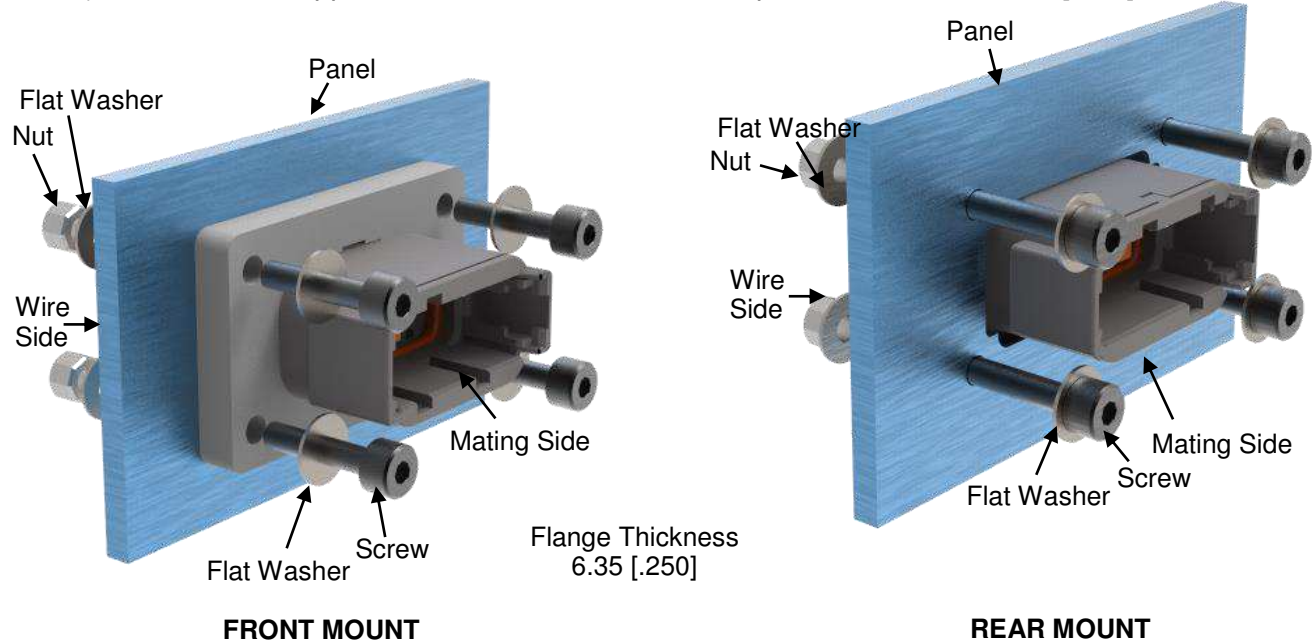

**Note:**

1. It is recommended to add flat washer under the head of the fastener and nut to prevent damage to flange.
2. Do not over tighten fastener. This will prevent damaged or broken receptacle and/or flange.
3. Do not side load the receptacle. This will prevent damage or broken receptacle and/or flange.
4. Optional gasket forms a dust/splash proof seal only, see Section I for more information.
5. Weld-on flange is not sealed.

### FLANGE – L025 TYPE

Insert wire side of receptacle through the panel cutout.

Recommended screw size is M4 [6-32]. Length dependent on application. Recommended screw torque is 3.1-4.0 Nm [27.44-35.4 in-lb.]. Recommended mounting hardware (i.e. flat washers, screws) are customer supplied.

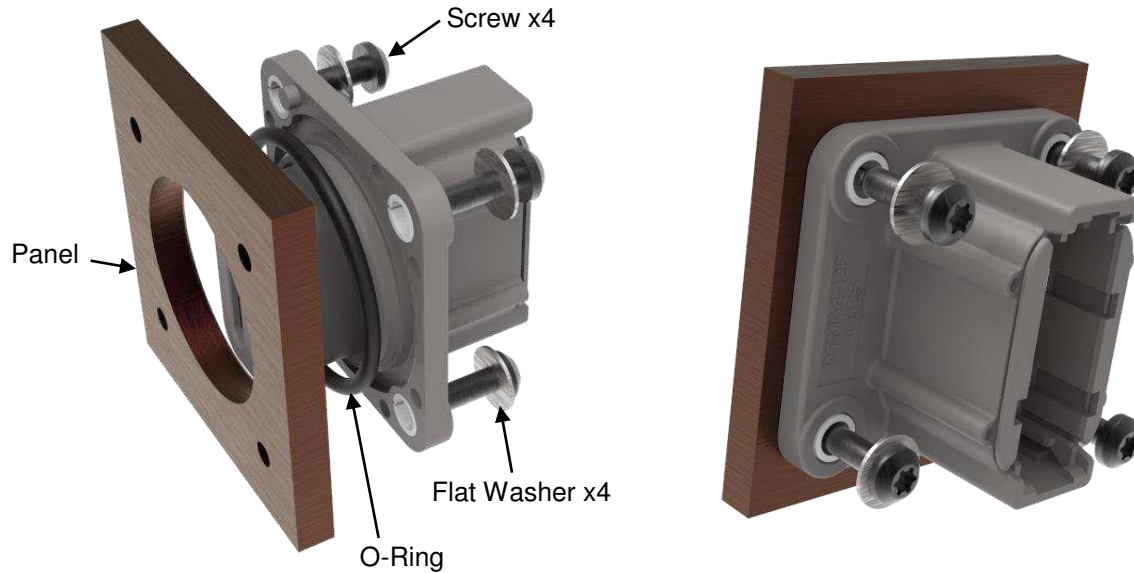

**NOTE:**



- 1) *It is recommended to add a flat washer under the head of the fastener.*
- 2) *Do not over tighten the fastener. This will prevent damaged or broken receptacle and/or flange.*
- 3) *Do not side load the receptacle. This will prevent damaged or broken receptacle and/or flange.*

### 3.12. Replacement and Repair

Damaged or defective connectors must not be used. These connectors cannot be repaired.

### 4. QUALIFICATION

Refer to product specification [108-151010](#) for qualification and approved agency.

### 5. TOOLING

Refer to the following application specifications for reference on all pin and socket contact termination tooling.

[114-151003](#) Application Specification for DEUTSCH Size 20 S&F Pin and Socket Contacts

[114-151004](#) Application Specification for DEUTSCH size 4-20 Solid Pin & Socket

[DT-RT1](#) removal tool is designed to be used to unlock contacts from the connectors.



DEUTSCH Removal Tool [DT-RT1](#) for Front-Release Connectors ([408-151008](#))

## 6. HELPFUL HINTS

### Helpful hint

Proper wire outside diameters help provide water tight seal. See section 3.3.E for sealing ranges.

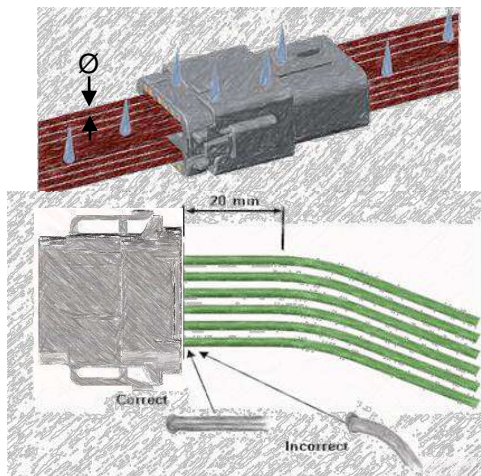

### Helpful hint

Proper wire routing assures water tight seal performance. Keep wire straight for 20mm minimum recommended, unless a plastic back shell is used.

### Helpful hint

Making the socket contact side the “hot side” can reduce the danger of electric shock.



### Helpful hint

Pulling lightly on the wire after it is snapped in place will assure the contact is locked.

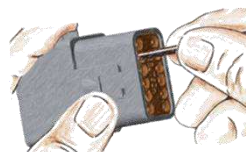

### Helpful hint

Sealing plugs are used to seal the connector when all the cavities are not used by wires.



### Helpful hint

Mounting connectors horizontally allows proper water drainage.

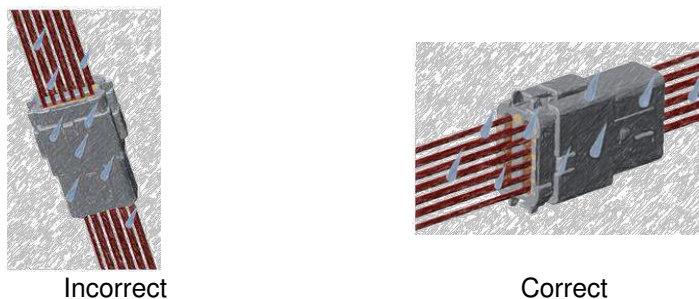

### Helpful hint

Attaching the connector to a structure eliminates straining the electrical system in service.

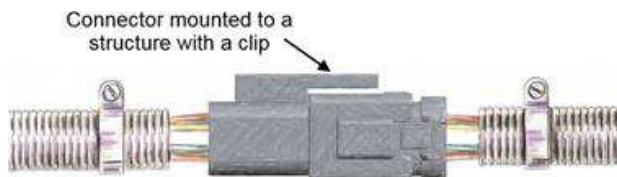

**Helpful hint**

Tie wraps and tape away from the rear of the connector will allow the wire to be sealed properly.

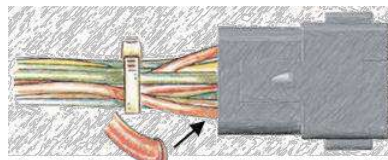

Incorrect

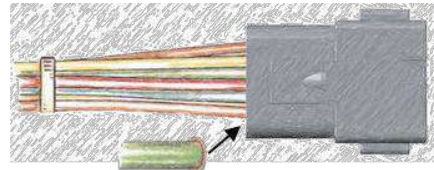

Correct

**Helpful hint**

The middle line of text on the housings can be either "USA", "IPD-USA", "INDUSTRIAL", or blank



**7. VISUAL AID**

Below shows a typical application of the DTM Series Connector. This illustration should be used by production personnel to ensure a correctly applied product. Applications which DO NOT appear correct should be inspected using the information in the preceding pages of this specification and in the instruction, material shipped with the product or tooling.

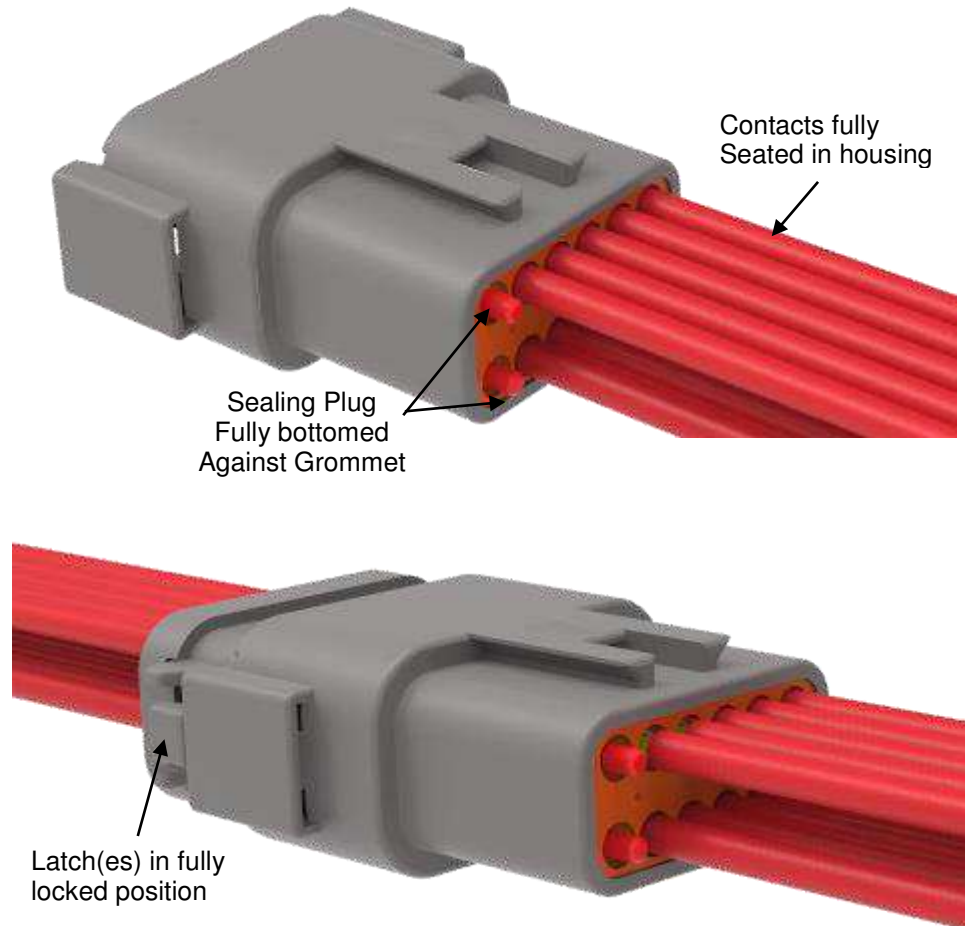



## 8. REVISION HISTORY

Rev	Brief Description of Change	Date	Dwn	Apvd
A	Initial Release	06/15/2019	JA	DM
B	Page 27: Added note at bottom of page " <i>Mounting clip is removable. Damage to receptacle retention feature may occur.</i> "	01/17/2020	DM	DM
C	Page 12: Added 2289860-1 (DTM8P-DC-L025) Page 15: Deleted 1028-027-0406 (incorrect PN) Page 15: Added 7.5mm tube to 1028-027-0405 Page 15: Added (Plug) to 1028-016-0005 Page 15: Added (Receptacle) to 1028-017-0005 Page 16: Added 2303064-1/2 to Connector PN	2020-07-15	DM	IG
C1	Page 5: Numerical order specifications, Updated spec titles, deleted 408-151008, fixed hyperlinks Page 17: Note 2. Added retention force for other clips Page 18: Sec 3.4, step 1. Updated specs like Sec 2.4 Page 19: Added hyperlink to M15570-20. Page 20: Added missing hyperlinks for DT-RT1 & 408-151008 Page 28: Second paragraph, corrected max panel thickness (is) 6.35 [.250] (was) 16.50 [.650] Page 28: Note 4. Clarified gasket is optional and added dust Page 28: Added Note 5 Page 29: Sec 5, Updated specs like Sec 2.4, fixed hyperlinks, updated DT-RT1 photo.	2020-08-26	DM	IG
D	Page 15: Connector Part Numbers relation with Backshells correction. Pag 26: Added backshell tie wrap guidance. Assembly Instructions	2024-13-06	RA	CB