



**NOTE**

All numerical values are in metric units [with U.S. customary units in brackets]. Dimensions are in millimeters [and inches]. Unless otherwise specified, dimensions have a tolerance of  $\pm 0.13$  [ $\pm .005$ ] and angles have a tolerance of  $\pm 2^\circ$ . Figures and illustrations are for identification only and are not drawn to scale.

**1. INTRODUCTION**

This specification covers the requirements for application of DEUTSCH DRC16 series connector system. The connector system features a plug and receptacle that offers 24,40,70-pin arrangement which accept DEUTSCH size 16 solid (machined) or stamped & formed contacts.

The DRC16 series features a center threaded coupling system for flange, in-line with silicone seals and rear insertion/rear removal contact system. Basic terms and features of this product are provided below.

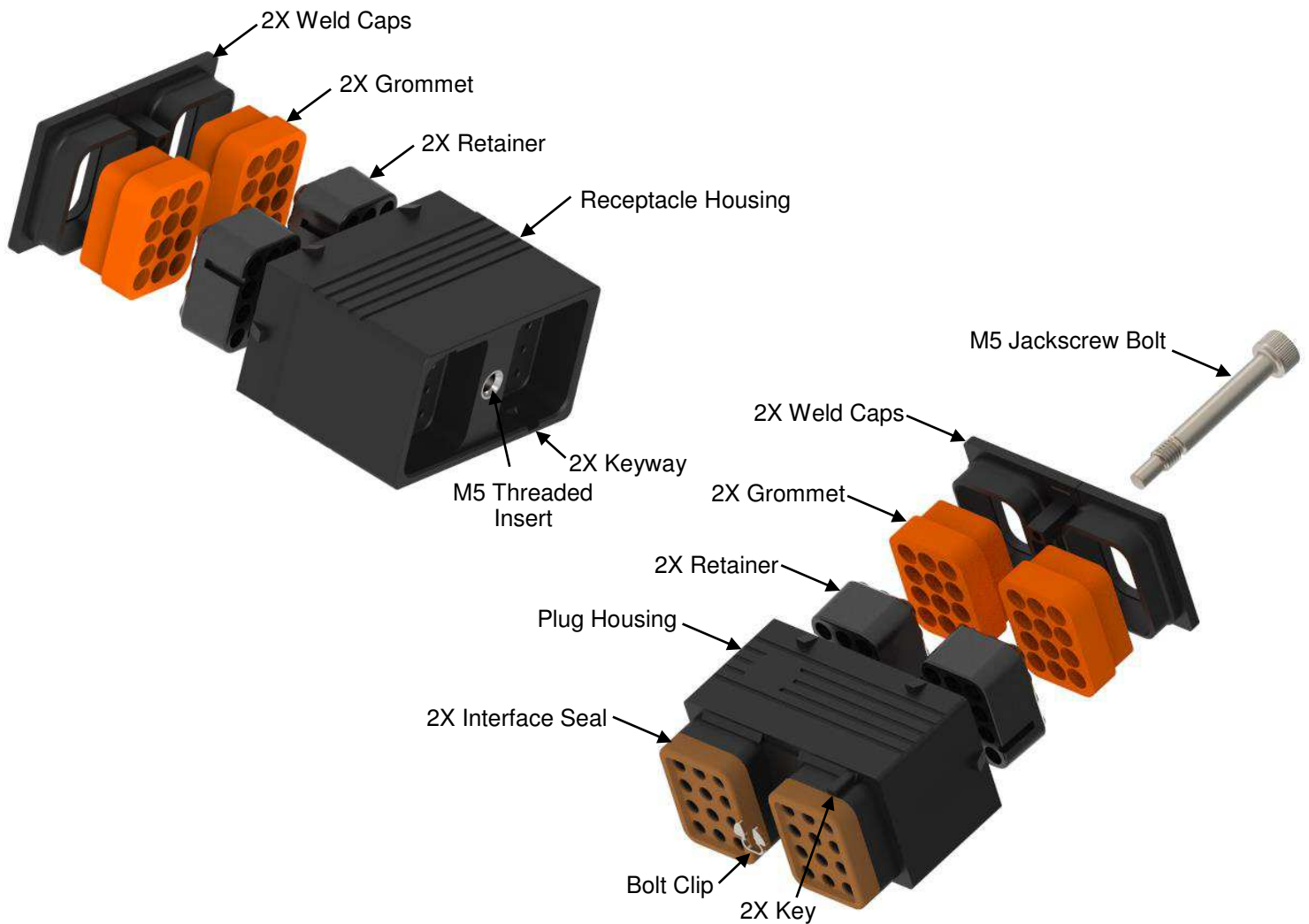

**Note:**

- 1) Plug and receptacles come with a LDPE protective cap. See Section 3.3 I

Standard Features All Arrangements  
(24-pin example)

### 1.1. Receptacle – Flange



DRC12-24P

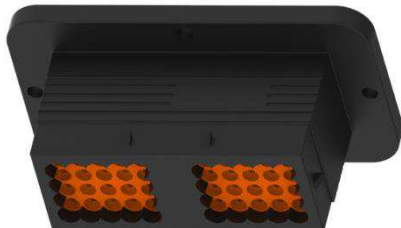

DRC12-40P



DRC12-70P

### 1.2. Receptacle – Inline



DRC14-24P

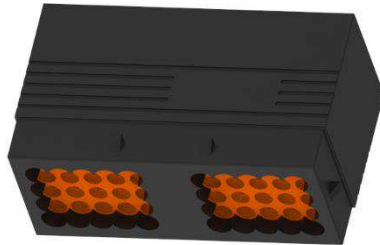

DRC14-40P



DRC14-70P

### 1.3. Plug



DRC16-24S



DRC16-40S

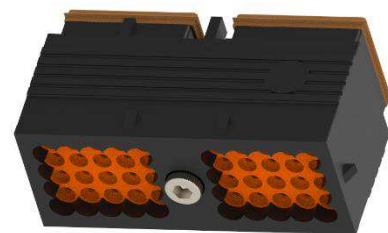

DRC18-40S



DRC16-70S

**1.4. Product Dimensions**

See connector product drawing for product dimensions. See section 2.3

**2. REFERENCE MATERIAL**

**2.1. Revision Summary**

See section 8

**2.2. Customer Assistance**

See Section 3.3A for Part Numbering System

Product Code J805 is representative of DEUTSCH DRC16 series connector system. Use of this number will identify the product line and help you to obtain product and tooling information when visiting [www.te.com](http://www.te.com) or calling the number at the bottom of page 1.

**2.3. Drawings**

Customer drawings for product part numbers are available from [www.te.com](http://www.te.com). Information contained in the customer drawing takes priority. Where X is seal type and XXXX refers to product modification.

**Receptacle Drawings**

<b>Product Drawing</b>	<b>Description</b>
<a href="#">DRC12-24PAX</a>	REC, 24P, BLK, FLANGE, A
<a href="#">DRC12-24PBX</a>	REC, 24P, BLK, FLANGE, B
<a href="#">DRC12-24PCX</a>	REC, 24P, BLK, FLANGE, C
<a href="#">DRC12-24PDX</a>	REC, 24P, BLK, FLANGE, D
<a href="#">DRC12-40PAX</a>	REC, 40P, BLK, FLANGE, A
<a href="#">DRC12-40PBX</a>	REC, 40P, BLK, FLANGE, B
<a href="#">DRC12-40PCX</a>	REC, 40P, BLK, FLANGE, C
<a href="#">DRC12-40PDX</a>	REC, 40P, BLK, FLANGE, D
<a href="#">DRC12-70PAX</a>	REC, 70P, BLK, FLANGE, A
<a href="#">DRC12-70PBX</a>	REC, 70P, BLK, FLANGE, B
<a href="#">DRC12-70PCX</a>	REC, 70P, BLK, FLANGE, C
<a href="#">DRC12-70PDX</a>	REC, 70P, BLK, FLANGE, D
<a href="#">DRC14-24PAX</a>	REC, 24P, BLK, A
<a href="#">DRC14-24PBX</a>	REC, 24P, BLK, B
<a href="#">DRC14-24PCX</a>	REC, 24P, BLK, C
<a href="#">DRC14-24PDX</a>	REC, 24P, BLK, D
<a href="#">DRC14-40PAX</a>	REC, 40P, BLK, A
<a href="#">DRC14-40PBX</a>	REC, 40P, BLK, B
<a href="#">DRC14-40PCX</a>	REC, 40P, BLK, C
<a href="#">DRC14-40PDX</a>	REC, 40P, BLK, D
<a href="#">DRC14-70PAX</a>	REC, 70P, BLK, A
<a href="#">DRC14-70PBX</a>	REC, 70P, BLK, B
<a href="#">DRC14-70PCX</a>	REC, 70P, BLK, C
<a href="#">DRC14-70PDX</a>	REC, 70P, BLK, D

## Plug Drawings

Product Drawing	Description
<a href="#">DRC16-24SAT</a>	PLG, 24P, BLK, T, A
<a href="#">DRC16-24SBT</a>	PLG, 24P, BLK, T, B
<a href="#">DRC16-24SCT</a>	PLG, 24P, BLK, T, C
<a href="#">DRC16-24SDT</a>	PLG, 24P, BLK, T, D
<a href="#">DRC16-24SX</a>	PLG, 24P, BLK, N, A,B,C,D
<a href="#">DRC16-24SX-P013</a>	PLG, 24P, BLK, SEAL BOND, A,B,C,D
<a href="#">DRC16-24SXE</a>	PLG, 24P, BLK, A,B,C,D
<a href="#">DRC16-24SXE-P013</a>	PLG, 24P, BLK, E, SEAL BOND, A,B,C,D
<a href="#">DRC16-40S</a>	PLG, 40P, BLK, N
<a href="#">DRC16-40S-P013</a>	PLG, 40P, BLK, N, SEAL BOND
<a href="#">DRC16-40SE</a>	PLG, 40P, BLK, E
<a href="#">DRC18-40SAX</a>	PLG, 40P, BLK, A
<a href="#">DRC18-40SBX</a>	PLG, 40P, BLK, B
<a href="#">DRC18-40SCX</a>	PLG, 40P, BLK, C
<a href="#">DRC18-40SDX</a>	PLG, 40P, BLK, D
<a href="#">DRC18-40SX-P013</a>	PLG, 40P, BLK, SEAL BOND, A,B,C,D
<a href="#">DRC18-40SX-PP02</a>	PLG, 40P, BLK, SEAL BOND, SS CLIP, A,B,C,D
<a href="#">DRC18-40SXE-P013</a>	PLG, 40P, BLK, E, SEAL BOND, A,B,C,D
<a href="#">DRC16-70SAT</a>	PLG, 70P, BLK, T, A
<a href="#">DRC16-70SAX</a>	PLG, 70P, BLK, N, A
<a href="#">DRC16-70SBX</a>	PLG, 70P, BLK, N, B
<a href="#">DRC16-70SCX</a>	PLG, 70P, BLK, N, C
<a href="#">DRC16-70SDX</a>	PLG, 70P, BLK, N, D
<a href="#">DRC16-70SX-P013</a>	PLG, 70P, BLK, N, SEAL BOND, A,B,C,D
<a href="#">DRC16-70SX-P019</a>	PLG, 70P, BLK, N, ZINC CLIP, A,B,C,D
<a href="#">DRC16-70SX-P057</a>	PLG, 70P, BLK, N, EXT BOLT LEAD-IN, A,B,C,D
<a href="#">DRC16-70SX-PP05</a>	PLG, 70P, BLK, N, SL BD, BOLT LEAD-IN, A,B,C,D
<a href="#">DRC16-70SXE-P013</a>	PLG, 70P, BLK, E, SEAL BOND, A,B,C,D
<a href="#">DRC16-70SXE-P057</a>	PLG, 70P, BLK, E, EXT BOLT LEAD-IN, A,B,C,D
<a href="#">DRC16-70SXE-PP05</a>	PLG, 70P, BLK, E, SL BD, BOLT LEAD-IN, A,B,C,D

## 2.4. Specifications

- [108-151000](#) Product Specification for DEUTSCH Stamped and Formed Contacts
- [108-151004](#) Product Specification for DEUTSCH Solid Contacts
- [108-151018](#) Product Specification DRC16 Series
- [114-94223](#) Application Specification for DRC16-70SXE
- [114-151000](#) Application Specification for DEUTSCH Size 16 S&F Pin and Socket Contacts
- [114-151001](#) Application Specification for DEUTSCH Size 16 S&F Pin and Socket Contacts
- [114-151004](#) Application Specification for DEUTSCH size 4-20 Solid Pin & Socket

## 2.5. Instructional Material

Instruction sheets (408-series) provide product assembly instructions or tooling setup, and operation procedures and customer manuals (409-series) provide machine setup and operating procedures. Instructional material that pertain to this product are:

- 408-151007 DEUTSCH Extraction Tools for Rear-Release Connectors
- 408-151066 DEUTSCH Sealing Plugs and Keying Pins
- 408-151078 DEUTSCH Extended PCB Pins

## 3. REQUIREMENTS

### 3.1. Safety

Do not stack product shipping containers so high that the containers buckle or deform.

### 3.2. Storage

#### A. Ultraviolet Light

Prolonged exposure to ultraviolet light may deteriorate the chemical composition used in the product material.

#### B. Shelf Life

The product should remain in the shipping containers until ready for use to prevent deformation to components. The product should be used on a first in, first out basis to avoid storage deterioration could adversely affect performance.

#### C. Chemical Exposure

Do not store product near any chemical listed below as they may cause stress corrosion cracking in the material.

Alkalis	Ammonia	Citrates	Phosphates	Sulfur Compounds	
Acids	Amines	Carbonates	Nitrites	Sulfur Nitrites	Tartrates



NOTE:

- 1) Resistance depends on chemical concentration, temperature, and exposure medium.

### 3.3. Characteristics

#### A. Part Numbering System

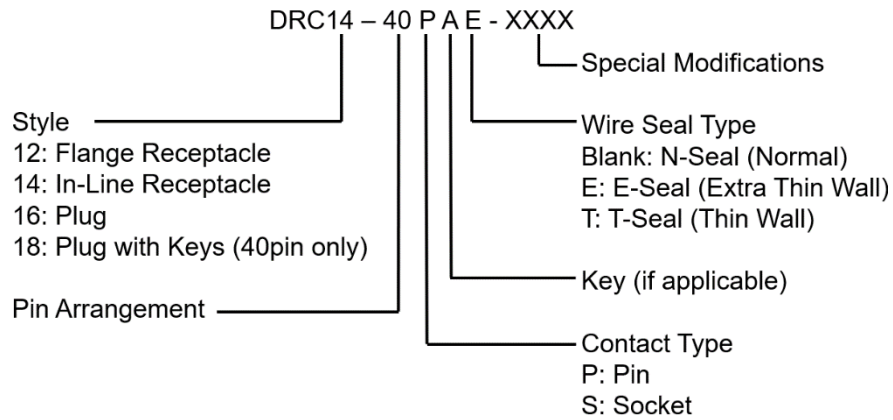

**i** *Note:*  
 Pins used in receptacle and Sockets used in plug.

#### B. Pin Arrangement

See product drawing for contact cavity marking

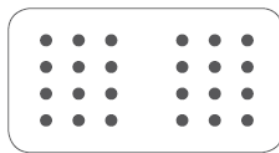

DRC1\*-24\*\*

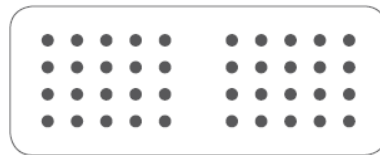

DRC1\*-40\*\*

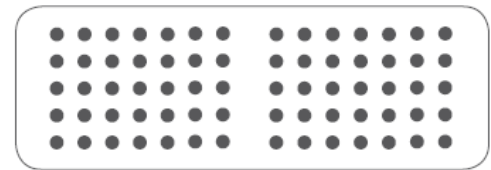

DRC1\*-70\*\*

#### C. Materials

Receptacle and Plug Housing	PPS GF40 (black)
Weld Cap	PPS GF40 (black, brown)
Protective Cap	LDPE (yellow, white)
Retainer	PEI (black)
Interface Seal	FVMQ (brown)
Grommet	VMQ (red-orange)
Threaded Insert	Stainless Steel, Unplated
Jackscrew Bolt	Stainless Steel, Silver
Bolt Clip	Steel, Unplated

**i** **NOTE**

1) Silver plated jackscrew bolt is coated with an anti-tarnish protective coating. This protective coating loses its protective effect after 6 months to 2 years, depending on the respective ambient conditions. This leads to oxidation (tarnish) of the silver and discoloration be yellow, tan, blue, brown or black. This discolored appearance is normal and does not affect product function.

2) Use sulfur-free gloves when handling the silver plated jackscrew bolt.

## D. Sealing Range

Conductor Range	Insulation OD Sealing Range in [mm]	Seal Type
14 -20 AWG [2.0 – 0.50 mm <sup>2</sup> ]	.100-.134 [2.54-3.40]	N-Seal
	.088-.134 [2.23-3.40]	T-Seal
	.053-.120 [1.35-3.05]	E-Seal

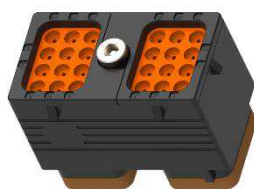

N-Seal

Black Weld Cap

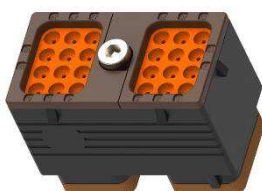

T-Seal

Brown Weld Cap





E-Seal

Blue Strip on Weld Cap

## E. Sealing Plugs

Open cavities provide pathways for contaminants to enter the connectors. To maintain seal integrity, any unused cavity must be filled with the appropriate size sealing plug. See [408-151066](#) for instructions.

Part Number	Material	Color	Description	Sealing Plug
<a href="#">114017</a>	PBT	White	Sealing Plug N,T,E	
<a href="#">0413-003-1605</a>	PBT	Blue	Sealing Plug T,E	
<a href="#">0413-217-1605</a>	PBT	White	Locking Plug N,T,E	

## F. Keying Pins

Keying pins are solid plastic rods used to help prevent mis-mating of like connectors in close proximity. Keying pins are inserted into the retention fingers of an empty socket cavity in the plug connector. Once installed, the keying pin blocks a mating contact pin from being inserted. The contact pin will be blocked before the coupling device mates the connectors, helping to prevent the mis-mating of like connectors. Proper usage requires that the corresponding mating pin be omitted, and a sealing plug inserted in the rear cavity of the mating connector. Individual applications will vary, and testing should be done to determine the best pattern arrangement to help prevent improper connector mating. See [408-151066](#) for instructions.

Part Number	Material	Color	Description	Sealing Plug
<a href="#">0413-215-1605</a>	PBT	White	Keying Pin N,T,E	



NOTE:

- 1) Multiple keying pins may be required to help prevent unintentional forced mating.

## G. Modification



NOTES:

- 1) Modifications include but are not limited to the following list.
- 2) Modifications listed are for reference only and may not be available for every arrangement.

Mod	Description
P013	Interface Seals are Bonded onto the Plug Housing
P019	Bolt Clip is Steel with Zinc Finish
P057	Jackscrew Bolt has Extended Lead-In
PP02	Interface Seals are Bonded onto the Plug Housing and Stainless Steel Bolt Clip
PP05	Interface Seals are Bonded onto the Plug Housing and Jackscrew Bolt as Extended Lead-In



## H. Panel Mounting Layouts

The flanged receptacle may use a panel cutout that allows the flange to be mounted on the inside of the panel.

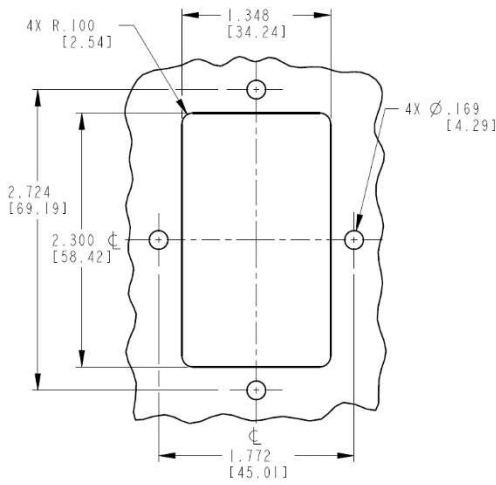

DRC12-24P

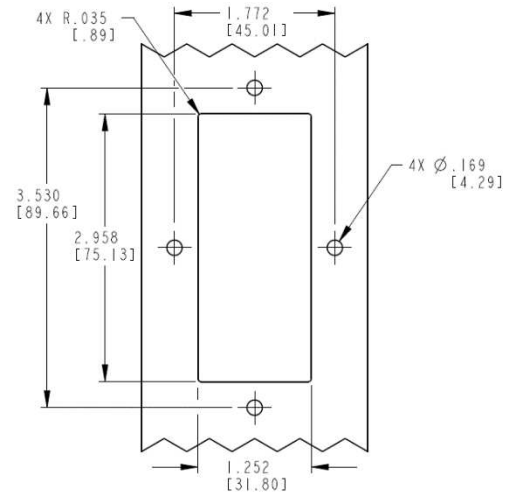

DRC12-40P

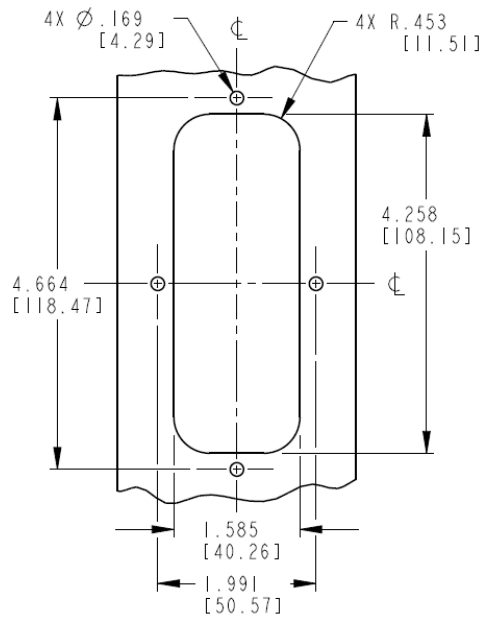

DRC12-70P



Note:

- 1) Tolerance:  $\pm .12$  [.005]
- 2) Surface:  $0.8 Ra$  [32 RMS] or better and .13 [.005]

## I. Accessories

Several accessory items can be used to complement the connectors such as PVC boots, plastic backshells, neoprene closed cell gaskets and protective dust caps. Accessories are designed to complete the application and meet a wide array of design requirements such as solutions for mounting, providing additional protection, and offering increased aesthetics.

### BOOTS

Slip-on boots are not only aesthetically appealing, but also provide increased protection from dirt, paint overspray and pressure washing.

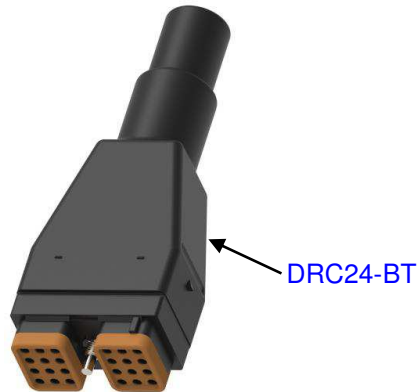

Part Number Receptacle	Description
<a href="#">DRC24-BT</a>	24 pin, Black
<a href="#">DRC24-BT-YW</a>	24 pin, Yellow
<a href="#">DRC40-BT</a>	40 pin, Black
<a href="#">DRC40-BT-90DEG</a>	40 pin, Black, 90°
<a href="#">DRC40-BT-GRAY</a>	40 pin, Gray
<a href="#">DRC40-BT-YW</a>	40 pin, Yellow
<a href="#">DRC70-BT</a>	70 pin, Black

Material: PVC

Operating temperature is -29°C to +100°C [-20° to +212°F].





NOTE:

1. Boot end is either open or closed. Cut end of boot off to desired length.

## DUST AND PROTECTIVE CAPS

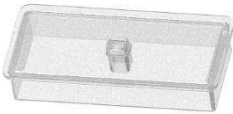
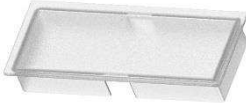
Dust caps provide an environmental seal and are used to protect the receptacle connector interface when the plug connector is not mated. Protective caps provide a non-environmental protection for the connector interface during assembly and shipping. The connector comes with a protective cap. The protect caps are not IP rated.

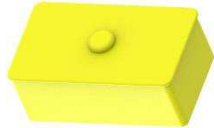
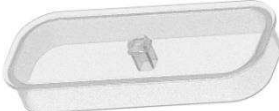
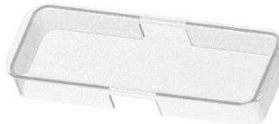
Part Number	Description	Material	Connector Part Number	Shape and Color
<a href="#">0504-001-4001</a>	Dust Cap, 40pin, Rcpt	PPS 40GF Black	DRC12-40P DRC14-40P	
0515-001-4005	Protective Cap, 40pin, Plug	LDPE White	DRC16-40S DRC18-40S	
0515-002-4005	Protective Cap, 40pin, Rcpt	LDPE White	DRC12-40P DRC14-40P	
<a href="#">0515-004-2405</a>	Protective Cap, 24pin, Rcpt	LDPE Yellow	DRC12-24P DRC14-24P	
<a href="#">0515-005-2405</a>	Protective Cap, 40pin, Plug	LDPE Yellow	DRC16-24S	
0515-006-7005	Protective Cap, 70pin, Plug	LDPE White	DRC16-70S	
0515-007-7005	Protective Cap, 70pin, Rcpt	LDPE White	DRC12-70P DRC14-70P	

### Operating Temperature

PPS 40GF -55°C to +125°C [-67° to +257°F]

LDPE -50°C to +85°C [-58° to +185°F]

## BACKSHELLS

Designed to snap onto and mate with all standard plug without modifications that affect the rear of the connector. The rigid, durable backshells offer a high level of protection and allow corrugated tubing to nest within or outside the rear of the backshell. Straight version and right angle backshells are available. Since the backshells are designed to work with the standard connectors, tests should be conducted for fit and function of a backshell being used on any part with a modification.

Plug Backshell			
Connector Part Number	Corrugated tubing size (mm)	Part Number	Description
DRC12-70P DRC14-70P DRC16-70S	NA	<a href="#">0515-031-7005</a>	Wire Router, 70 pin, Black
	26	<a href="#">0528-006-7005</a>	Backshell, 70 pin, Side AB, Black
	26	<a href="#">0528-012-7005</a>	Backshell, 70 pin, RA, No Rib, Black
	26	<a href="#">0528-013-7005</a>	Backshell, 70 pin, RA, Rib, Black

Material: PA66

Operating Temperature: -55°C to +125°C [-67° to +257°F]

[0515-031-7005](#)



[0528-006-7005](#), 2X



[0515-031-7005](#)

[0528-012-7005](#) or  
[0528-013-7005](#)



Note

1. See [114-94223](#) for additional information.

## GASKETS

Moisture, dirt, salt, sand, and road debris can all work their way into electrical panels through unsealed mounting flanges. These rugged high-quality gaskets form a splash proof seal between the panel face and connector flange to help keep out destructive elements. Gaskets are 3.18 [.125] thick.

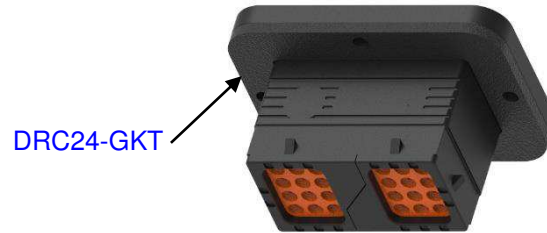

Part Number	Description	Connector Part Number
<a href="#">DRC24-GKT</a>	24 pin, Black	DRC12-24P
<a href="#">DRC24-GKT-AD</a>	24 pin, Black, with Adhesive	
<a href="#">DRC40-GKT</a>	40 pin, Black	DRC12-40P
<a href="#">DRC40-GKT-AD</a>	40 pin, Black, with Adhesive	
<a href="#">DRC70-GKT</a>	70 pin, Black	DRC12-70P
<a href="#">DRC70-GKT-AD</a>	70 pin, Black, with Adhesive	

Material: Closed Cell Sponge.

Operating Temperature: -57°C to +107°C [-70° to +225°F]

Gaskets are not IP rated

## EXTENDED PCB PINS

Straight reduced diameter extended pins are available for installation in the HD Series connectors. The use of removable contacts provides design flexibility and a low cost alternative to meet application needs. These solid copper alloy pins may be specified in various plating's. See [408-151078](#) for instructions.



### 3.4. Contact Insertion

- The crimped contact must meet these specifications:
  - [114-151000](#) Application Specification for DEUTSCH Size 16 S&F Pin and Socket Contacts
  - [114-151001](#) Application Specification for DEUTSCH Size 16 S&F Pin and Socket Contacts
  - [114-151004](#) Application Specification for DEUTSCH size 4-20 Solid Pin & Socket
- Ensure the correct connector configuration is being used before inserting contacts. Receptacle connector uses Pin and Plug connector uses Socket.
- Push contact straight into grommet until positive stop is felt. The contact will lock into place. A slight tug on wire will confirm that is properly locked in place.



**Note**

- Wire insulation outside diameter must meet connector wire sealing range per section 3.3.D.
- Insertion tool, [M15570-16](#) (size 16) may be needed for 20 AWG [0.50mm<sup>2</sup>] wire.

### 3.5 Contact Insertion Tool

Insertion tools are used to help insert small gage wired contacts into connectors that utilize a round shoulder contact retention system. Insertion tools are compact, easy-to-use and made with durable plastic to insert wired contacts without damage to wire, insulation, rear grommet seal or connector housing.

#### USING THE TOOL

- Insert the wired contact into the colored end wire entry slot and gently pull back until the contact locking shoulder is against tool.
- Push the tool/wired contact assembly into the connector rear until the contact is felt snap into position within the retainer.
- While holding the wire forward, gently pull remove tool out.
- A slight tug on wire will confirm the contact is properly locked in place.

Contact Size	Part Number	Mil-Spec	Color Insertion	Insertion Tool
16	M15570-16	M81969/14-03	Blue	



**CAUTION**

Do not twist or insert the insertion tool at an angle; otherwise, damage to the cavity retention finger(s) will result.

### 3.6. Contact Removal

DEUTSCH removal tools are designed to simplify contact removal and field service repair in connectors that utilize a round shoulder contact retention system. Removal tools are compact, easy-to-use, and manufactured of heavy duty plastic to remove contacts without damage to the wire, insulation, connector seals, or connector body.

Each extraction tool is designed to extract individual DEUTSCH solid and stamped and formed (S&F) pin and socket contacts from rear-release connectors. See [408-151007](#) for instructions.

#### USING THE TOOL

1. From the rear of the connector, align the tool tip with the contact cavity of the contact to be removed. Place the wire of the contact over the tool wire entry slot and apply light pressure on the wire until it enters the wire entry slot. See Detail A.
2. Slide the tool along the wire and into the contact cavity until the tool tip engages the contact and resistance is felt. See Detail A.
3. Gently pull the tool with the wire until the contact is removed. See Detail B.

Detail A



Detail B

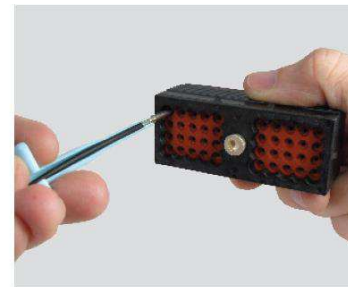

**CAUTION**

*Do not twist or insert the extraction tool at an angle; otherwise, damage to the cavity retention finger(s) will result.*

#### EXTRACTION TOOLS

Part Number	Contact Size	Wire Gauge Range	Extraction Tool
<a href="#">0411-291-1405</a>	Size 16	14-16 AWG	
<a href="#">0411-310-1605</a>	Size 16	16-20 AWG	
<a href="#">0411-336-1605</a>	Size 16	16-20 AWG (E-Seal)	

### 3.7 Sealing Plug, Locking Sealing Plug and Keying Pin Installation

#### SEALING PLUG (408-151066)

1. Holding the sealing plug with large diameter end away from the connector, gently apply downward pressure to force the sealing plug into the cavity.

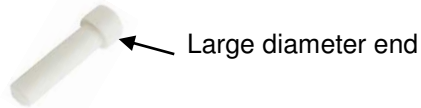

2. With perpendicular motion, apply downward pressure to the large diameter end of the sealing plug.

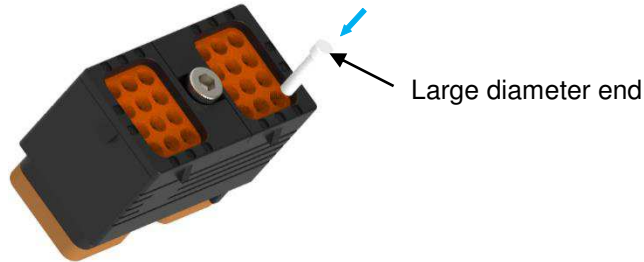

3. Apply pressure until sealing plug is forced to stop by contact with rear grommet. Visually inspect the sealing plug to confirm it is flush with cavity opening.



#### LOCKING SEALING PLUG (408-151066)

1. Holding the sealing plug with locking shoulder end towards the connector, gently apply downward pressure to force the sealing plug into the cavity.

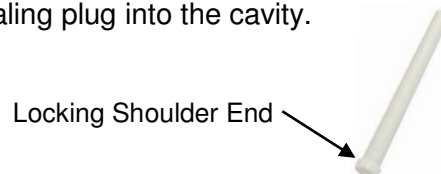

2. With perpendicular motion, apply downward pressure to the small diameter end of the sealing plug.

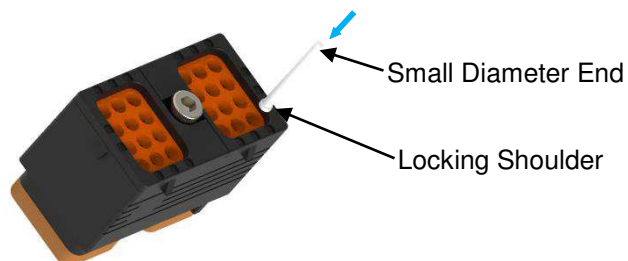



3. Apply pressure until sealing plug locks into place. A slight tug on the sealing plug will confirm it is locked into place.



**KEYING PIN (408-151066)**

1. Holding the keying pin with large diameter end towards the connector, gently apply downward pressure to force the sealing plug into the cavity.

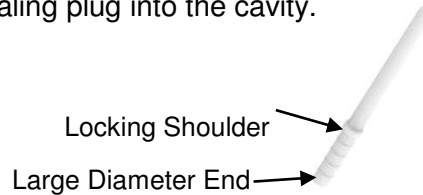

2. With perpendicular motion, apply downward pressure to the small diameter end of the sealing plug.

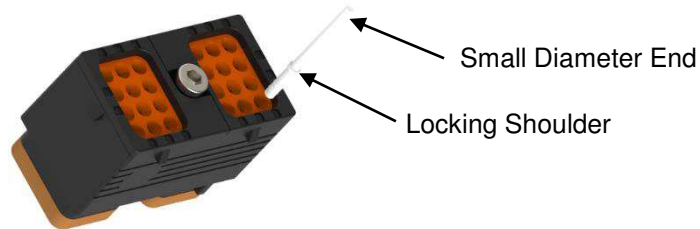

3. Apply pressure until keying pin locks into place. A slight tug on the sealing plug will confirm it is locked into place.



### 3.8 Connector Mating

To mate the plug and receptacle, align the plug key and receptacle keyway as shown. Once aligned, use a M4 hex tool turn the jackscrew bolt clockwise until completely mated. Recommended torque: 2.82-3.13 Nm [25-28 in-lbf].

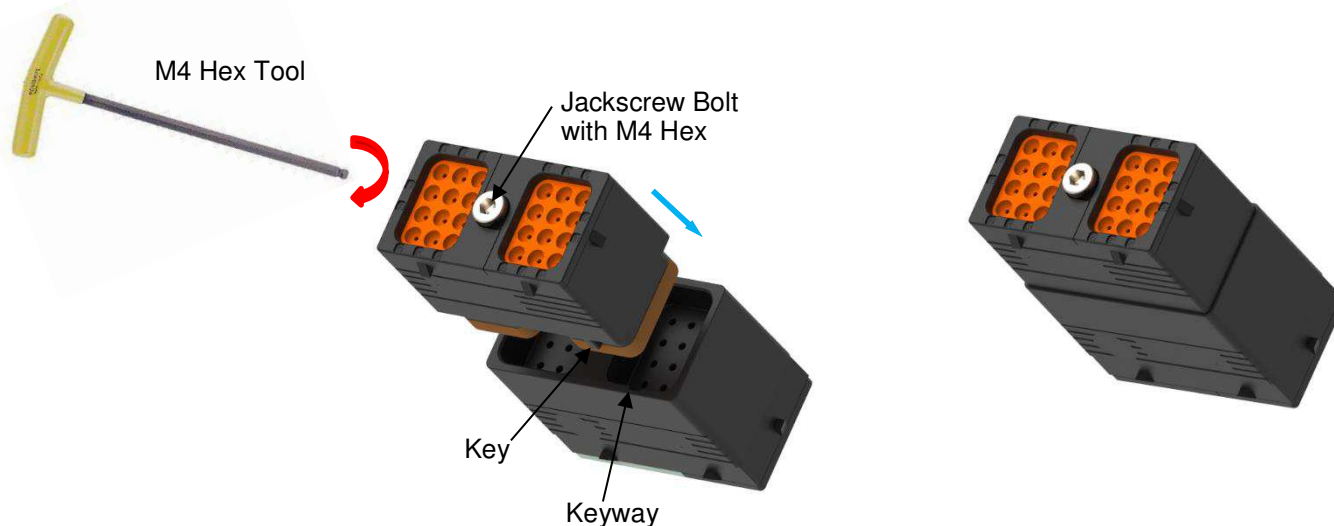

**CAUTION** Do not over torque the jackscrew bolt or possible damage to the housing(s) may occur.

- i** Note
2. It is not recommended to use dielectric grease on either plug or receptacle. The DRC16 connectors are guaranteed to seal and perform per [108-151018](#) product performance without the application of grease or other foreign substance.
  2. A ball-tip M4 hex tool is recommended for ease of use.

### 3.9 Connector Unmating

To unmate the plug and receptacle, use a M4 hex tool turn the jackscrew bolt counterclockwise until completely unmated. Separate plug from receptacle.

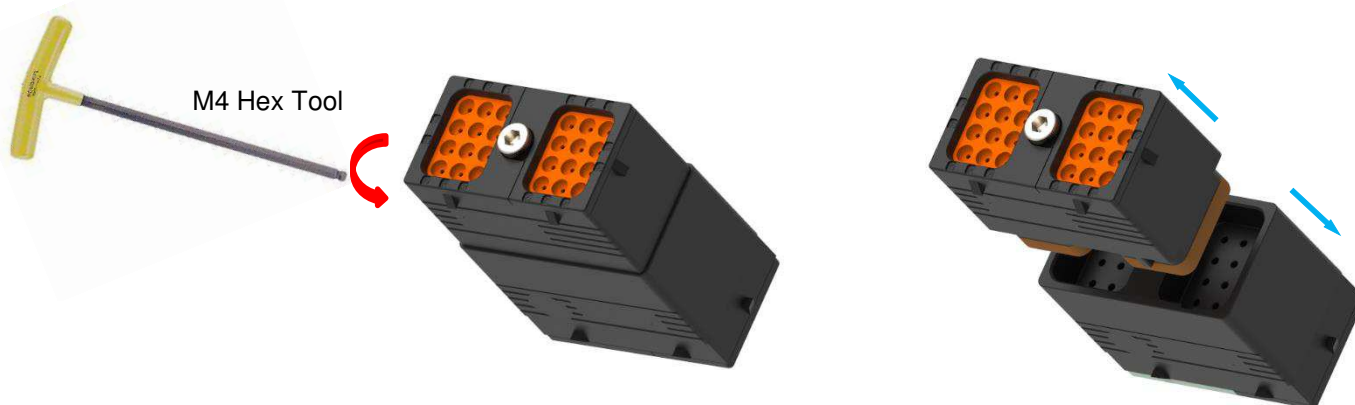

### 3.10. Wire Router, Backshell, Boot, Gasket, Protective Dust Cap Installation and Removal

See section I for part numbers.

#### WIRE ROUTER AND BACKSHELL

1. Installation of 0528-006-7005 backshell halves first requires 0515-031-7005 wire router. The wire route is symmetrical. Snap-on the wire router. Install the wires through the wire router and into the plug.

2. 0515-031-7005

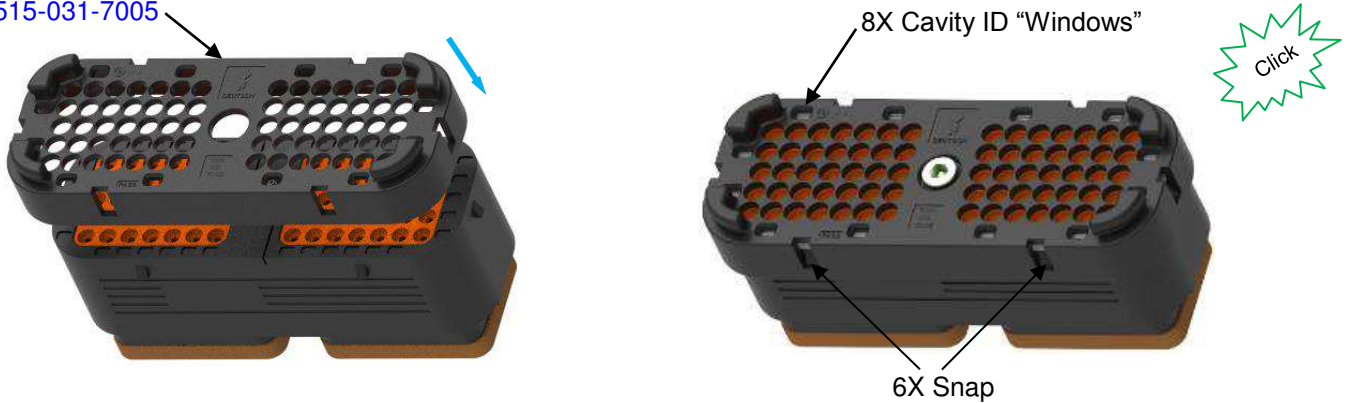

**Note**

1. Wire router maybe used with or without the backshell.

3. Align one of the backshell half onto the wire router. Repeat the second backshell half. Snap both halves together.



4. Remove in reverse steps.

## BACKSHELL

1. Installation of [0528-012-7005](#) or [0528-013-7005](#) does not require the wire router. First, make sure the backshell is in the open position. The backshell is symmetrical. Snap-on the backshell. Install the wires through the backshell and into the plug. Close backshell cover and push in the jackscrew bolt cover. Close backshell cover and push in the jackscrew bolt cover.

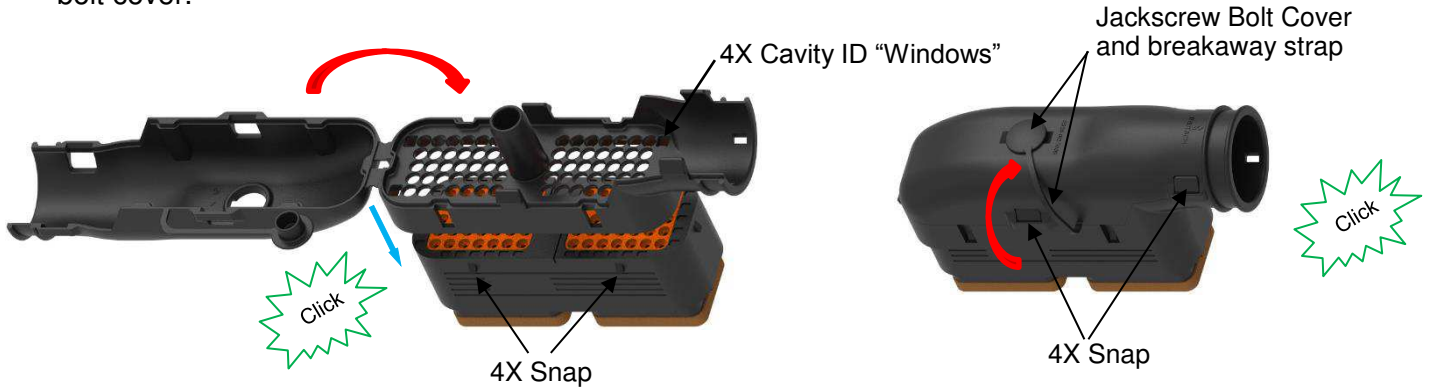

### Note

1. The jackscrew bolt cover is equipped with a break-away strap. After the cover is closed into the backshell, the strap may break.

2. Remove in reverse steps.

## BOOT

First, insert the wires into the connector. Next, cut off the end of the boot as needed then pass through the wires through the boot. Slide the boot onto the connector. If needed, attach a tie wrap on the end of the connector and boot. Trim tie wrap as needed.

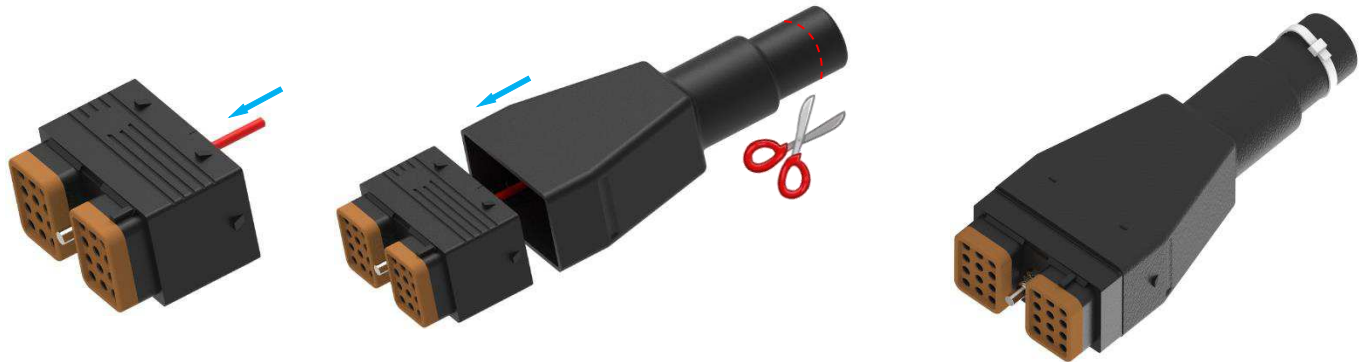

## GASKET

5. Install the gasket onto the connector on the rear of the flange. Next install into panel mounting hole. See section 3.11 for panel installation. Remove in reverse steps.



### PROTECTIVE DUST CAP

To mate the protective dust cap to the receptacle, use a M4 hex tool turn the jackscrew bolt clockwise until almost completely mated. Recommended torque: 2.82-3.13 Nm [25-28 in-lbf].

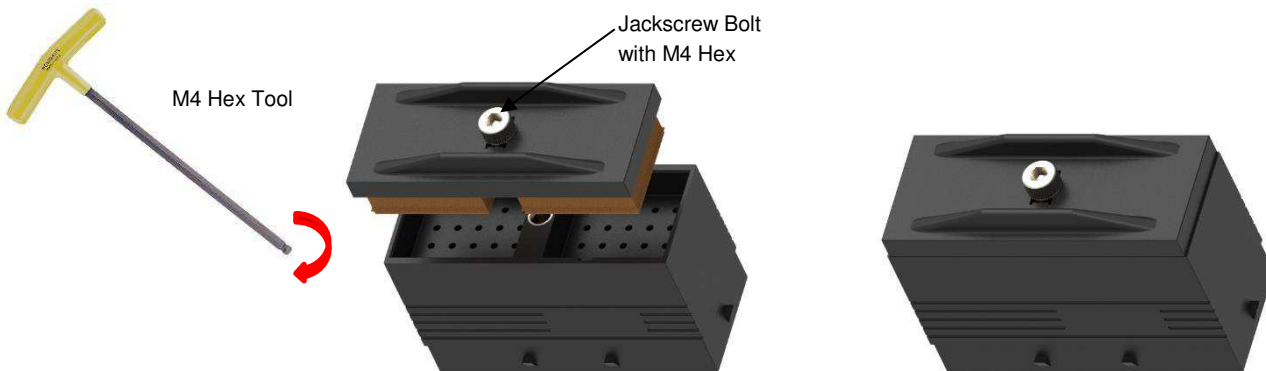

### 3.11. Panel Installation

The receptacles may be mounted to a panel as shown. If a gasket is used, ensure the gasket is installed onto the housing before inserting mating side through the panel cutout. Mounting hardware (i.e. screws, washer, nuts) are customer supplied.

Recommended screw size is M4 [8-32]. Screw length depend on application.

Recommended torque: 2.26-2.82 Nm [20-25 in-lbf]

Panel thickness: 6.35 [.250] max

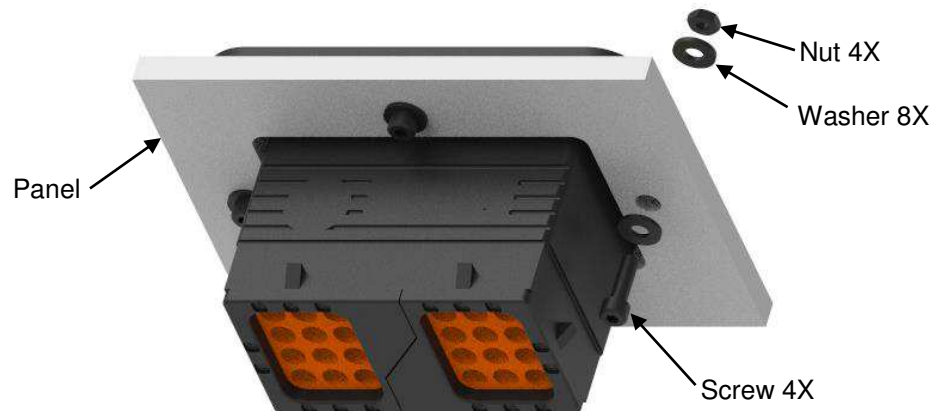

**CAUTION**

*Do not over torque mounting hardware. Mounting torque must not damage receptacle mounting flange.*

### 3.12. Replacement and Repair

Damaged or defective connectors must not be used. These connectors cannot be repaired.

### 4. QUALIFICATION

Refer to product specification [108-151018](#) for qualification and approved agency.

### 5. TOOLING

Refer to the following application specifications for reference on all pins and sockets contact termination tooling

- [114-151000](#) Application Specification for DEUTSCH Size 16 S&F Pin and Socket Contacts
- [114-151001](#) Application Specification for DEUTSCH Size 16 S&F Pin and Socket Contacts
- [114-151004](#) Application Specification for DEUTSCH size 4-20 Solid Pin & Socket

### 6. HELPFUL HINTS (HD shown as example)

**Helpful hint**

Proper wire outside diameters help provide water tight seals.

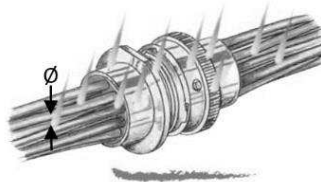

**Helpful hint**

Proper wire routing assures. Water tight seal performance

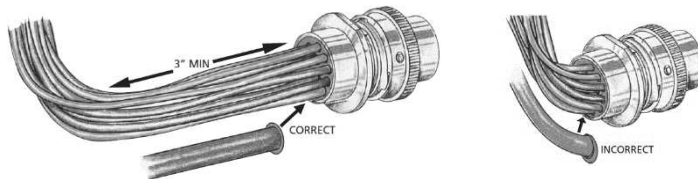

**Helpful hint**

Pulling lightly on the wire after it is snapped in place will assure the contact is locked.

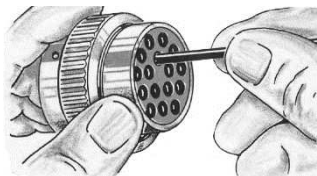

**Helpful hint**

Sealing plugs are used to seal the connector when all the cavities are not used by wires.

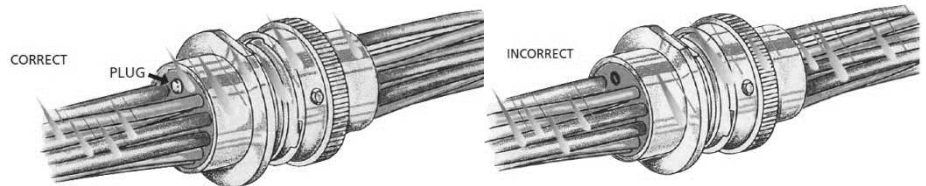

**Helpful hint**

Mounting connectors horizontally allows proper Water drainage.

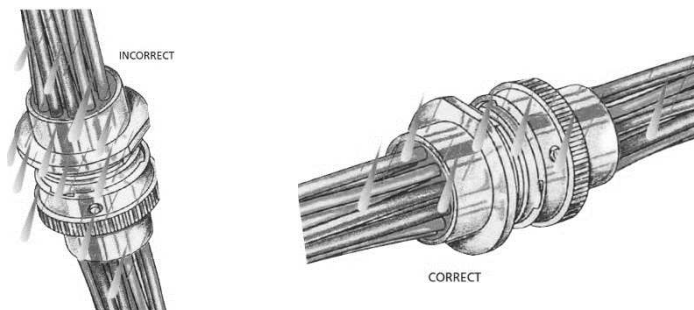

**Helpful hint**

Planned wire routing and clamp points can reduce harness cost by eliminating strain reliefs.

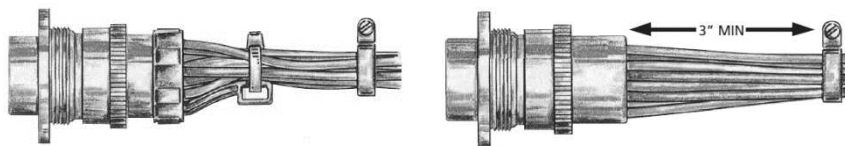

**Helpful hint**

Attaching the connector to a structure eliminates straining the electrical system in service.

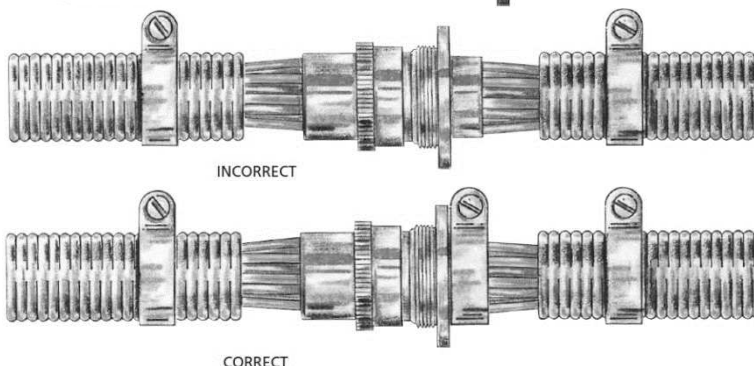

**Helpful hint**

Tie wraps and tape away from the rear of the connector will allow the wire to be sealed properly.

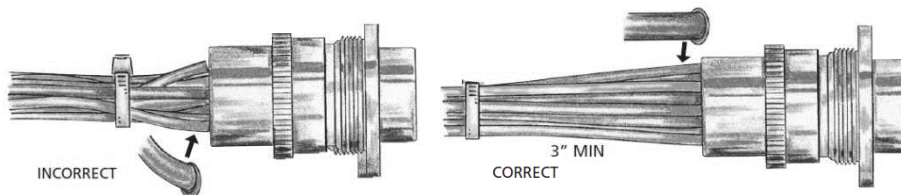

**Helpful hint**

Harness design should permit filling the connector cavities from the center out in order to provide support for the center of the harness and to allow easier connector assembly.

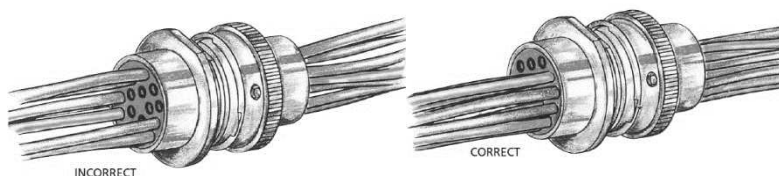

**Helpful hint**

A contact removal tool taped or tie wrapped to the harness will make it easily available should repairs be needed.

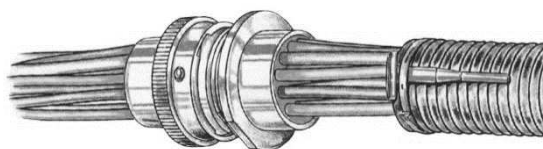

## 7. VISUAL AID

Below shows a typical application of the DRC16 Series Connector. This illustration should be used by production personnel to ensure a correctly applied product. Applications which DO NOT appear correct should be inspected using the information in the proceeding pages of this specification and in the instruction, material shipped with the product or tooling.

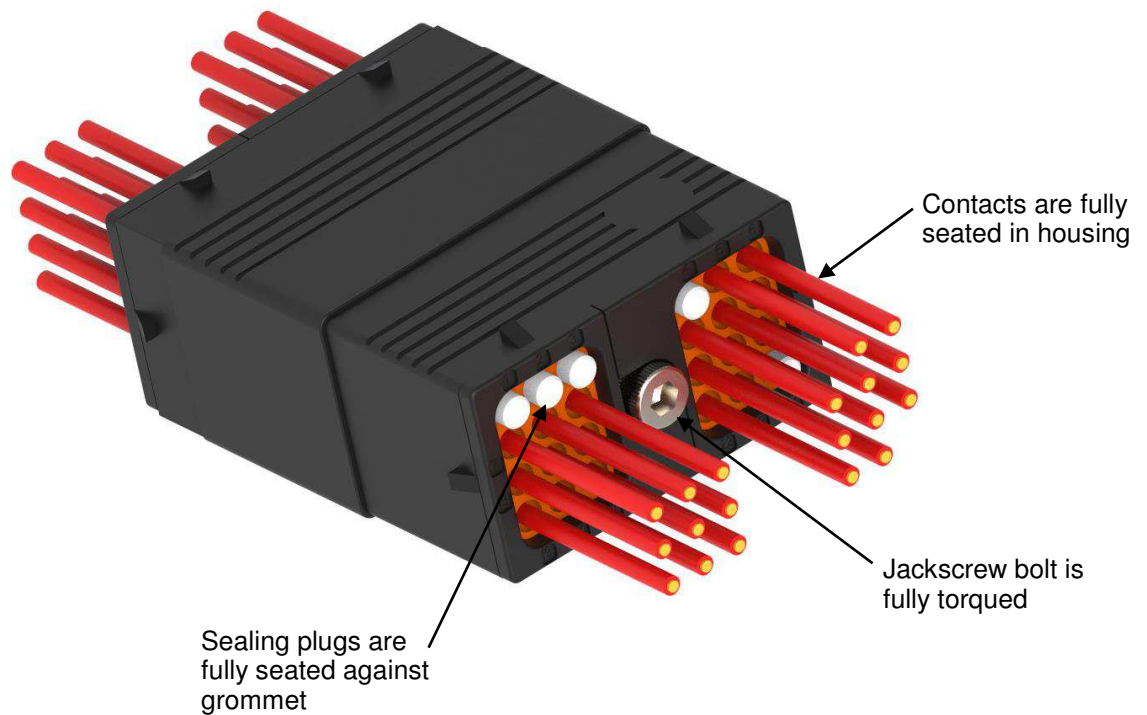



---

## 8. REVISION HISTORY

Rev Ltr	Brief Description of Change	Date	Dwn	Apvd
A	Initial Release	10-Nov-20	DM	IG