

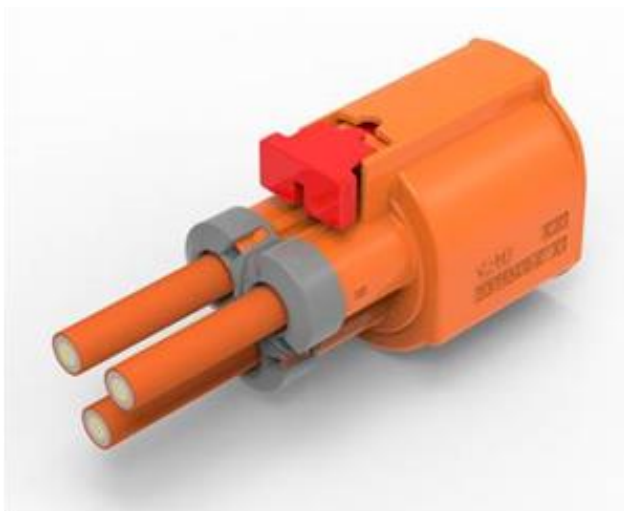

HVA HD400 2POS & 3POS Plug Connector Application Specification

HVA HD400 两位&三位母端高压连接器 应用规范



				PR: Z.CHEN DATE:02AUG2021	 TE Connectivity Shanghai, China		
				CHK: J.LI DATE:03AUG2021			
A10	Revised	S.W	13SEP2024	APP: I.YIN DATE:03AUG2021		Document No.: 114-160093	LOC: ES
LTR	REVISION RECORD	PR	DATE				



CONTENT 目录

1. SCOPE 适用范围	3
1.1 Content 内容	3
1.2 Processing notes 加工说明	3
2. APPLICABLE DOCUMENTS 适用文件	3
2.1 TE Connectivity Documents 泰科电子文件	3
2.1.1 Customer drawings 客户图纸	4
2.1.2 Specifications 规范	5
2.2 General Documentation 通用文档	5
2.2.1 Cable Specification 线缆规格	5
3. CONDITION OF DELIVERY AND PACKAGING 交货和包装状态	5
3.1 Components 零部件	5
3.2 Packaging and Storage 包装和贮存	8
4. APPLICATION TOOLS 应用工装	8
4.1 4MM round contact / 4MM 圆形端子	8
4.2 Shielding 屏蔽	9
5. ASSEMBLY INSTRUCTIONS 组装说明	10
5.1 Overview of all parts should be assembled 全部部件总览图	10
5.2 Cable components assembly 线缆组件组装	11
5.2.1 Pre-load inner ferrule, single wire seal, cable clip 预组装屏蔽内环, 线缆密封圈, 导线卡夹	11
5.2.2 Cable strip 线缆裁切	11
5.2.3 Contact crimp 端子压接	12
5.2.4 Install inner ferrule 屏蔽内环的组装	12
5.2.5 Insert the outer ferrule 组装屏蔽外环	12
5.2.6 Shielding crimp 屏蔽压接	13
5.3 Plug Housing assy 母端壳体组装	14
5.3.1 Insert cable assembly into the Plug Housing 线缆组件装入母端壳体	14
5.3.2 Assemble cable seal assembly 组装线材密封组件	14
5.3.3 Press TPA to end-lock position TPA 压到终锁位	15
6. FINAL EXAMINATION 终检	15
6.1 Visual Examination 外观检查	15
6.2 Electrical Tests 电气测试	15
7. HEADER ASSY AND PLUG ASSY MATING/ UNMATING INSTRUCTIONS 公母端安装说明	16
7.1 Header assy and plug assy mating 公母端连接器互配	16
7.2 Header assy and plug assy un-mating 公母端连接器解除互配	17
8. APPENDIX 附录	18
8.1 Data sheets 数据表	18
8.1.1 KBE shield cable 2.5 / 4 / 6mm ² KBE 2.5 / 4 / 6mm ² 屏蔽线	18
8.1.2 FORCE shield cable 2.5 / 3 / 4 / 6mm ² FORCE 2.5 / 3 / 4 / 6mm ² 屏蔽线	18
8.1.3 H&S shield cable 2.5 / 4mm ² H&S 2.5 / 4 / 6mm ² 屏蔽线	19



- ◆ This connector is intended for use in high-voltage applications. Special care must be applied to ensure that the connector functions as intended.
- ◆ If you suspect that the connector has been modified, damaged, contaminated or other wise compromised, please discontinue it use immediately.
- ◆ This connector should only be serviced by a trained and qualified technician.

1. SCOPE 适用范围

1.1 Content 内容

This specification covers the requirements for application of the sealed HVA HD400 2P&3P High Voltage connector. The HVA HD400 2P&3P connector system is designed to meet LV215-1 specifications and for a metric wire size range of 2.5mm² up to 6mm² (acc. to LV216-2) and 6mm² (acc. to ISO SEPC). The connector incorporates conductive EMI shields to reduce radiated emissions in the application.

The HVA HD400 2P&3P connector is available for 6 different keying or polarizing configurations. The connector system incorporates the 4mm round contacts and an integrated High Voltage Interlock (HVIL) System. The housings are molded in orange to denote a high voltage system.

该规范涵盖了HVA HD400 2P&3P高压密封连接器的应用要求。HVA HD400 2P&3P连接器系统的设计符合LV215-1规范，公制线径范围为2.5mm²至6mm²（符合LV216-2标准）和6mm²（符合ISO标准）。该连接器采用导电EMI屏蔽，以减少应用中的辐射。

HVA HD400 2P&3P 连接器有6种不同的键位。连接器系统包含4毫米圆形电源连接系统和集成的高压互锁（HVIL）系统和高压手指防护（IPXXB）要求。外壳采用橙色模制，表示高压系统。

1.2 Processing notes 加工说明

The processor is responsible for ensuring the quality of the manufacturing process and the proper function of the system. The warranty and liability is excluded, if quality deficiency or damages occurs by failing compliance to this specification or using not specified, not released tools or not released connector components.

加工者负责确保制造过程的质量和系统的正常功能。如果由于未遵守本规范或使用未定义的、未发布的工装或未发布的连接器组件而导致质量异常或损坏，则不承担保修和责任。

2. APPLICABLE DOCUMENTS 适用文件

The following mentioned documents are part of this specification. If there is a conflict between the information contained in the documents and this specification or with any other technical documentation supplied, the last valid customer drawings takes preference.

以下提到的文件是本说明书的一部分。如果文档中包含的信息与本规范或提供的任何其他技术文档之间存在冲突，则以最新有效的客户图纸优先。

2.1 TE Connectivity Documents 泰科电子文件

This Application Specification based on the latest valid customer drawings.

本应用规范基于最新的有效客户图纸。



2.1.1 Customer drawings 客户图纸

Table 1: Customer drawings 客户图纸

Header side (Include interface) / 公端(包括应用面板)	
2371113	2POS& 3POS,4MM,HEADER HSG,ASSY
2349180	DIA. 4MM MALE PIN
1418754	TAB CONTACT 1.2MM
2389821	DUST COVER
Plug side / 母端	
2371035	2POS & 3POS,4MM,PLUG HSG, ASSY,SEALED
2349177	DIA. 4MM SOCKET TERMINAL
2371242	INNER FERRULE
2371243	OUTER FERRULE
2371244 / 2428376	SINGLE WIRE SEAL
2371245	CABLE CLIP
2420809	DUST COVER
Blind plug / 盲堵	
2-2371035-1	BLIND PLUG
Application tools / 应用工装	
2375591	4MM male contact crimp tool(for 2.5 mm ² / 3 mm ² / 4 mm ² cable)
2375592	4MM socket contact crimp tool(for 2.5mm ² / 3 mm ² / 4mm ² cable)
2375593	4MM male contact crimp tool(for 4mm ² & 6mm ² cable)
2375594	4MM socket contact crimp tool(for 4mm ² & 6mm ² cable)
2374311-1	Shield crimp tool
2151311(1528428)	MCON1.2 contact crimp tool
4-1579001-3	MCON1.2 contact Hand crimp tool



2.1.2 Specifications 规范

Table 2: TE-specifications / 泰科规范

Specifications	Description
108-32306	Product Specification 4MM contact system
108-18782	Product Specification MCON1.2 Contact system
108-160170	Product Specification HVA HD400 2POS & 3POS connector
108-161013	Product Specification HVA HD400 BLIND PLUG connector
114-160038	Application Specification 4MM contact system
114-18464	Application Specification MCON1.2 Contact system
114-160093	Application Specification HVA HD400 2POS & 3POS Plug
114-160095	Application Specification HVA HD400 2POS & 3POS Header

2.2 General Documentation 通用文档

2.2.1 Cable Specification 线缆规格

The connector is designed to meet LV216-2 specification for metric wire range 2.5mm² / 3 mm²/ 4mm² / 6mm².

And ISO specification for metric wire 6mm². Cable Specification acc. To the appendix.

连接器设计符合LV216-2规范,适用于公制线缆范围2.5mm²、3 mm²、4mm²、6mm² 及ISO规范适用于公制线缆6mm²，线缆规格见附录。

3. CONDITION OF DELIVERY AND PACKAGING 交货和包装状态

3.1 Components 零部件

HVA HD400 2POS and 3POS plug connectors are currently available for three types of shield cable, Table 3 shows the components required for FORCE shield cable , Table 4 shows the components required for KBE shield cable , Table 5 shows the components required for H&S shield cable.

HVA HD400 2POS和3POS母端连接器目前可使用三种类型的屏蔽电缆，如表3所示使用 FORCE 屏蔽电缆所需的组件，如表4所示使用 KBE 屏蔽电缆所需的组件，如表5所示使用 H&S 屏蔽电缆所需的组件。



Application Specification

114-160093
Rev A10

Table 3 shows the required components for assembly of HVA HD400 2POS & 3POS Plug Connector using FORCE shield cable







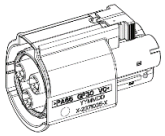

Description 描述	Picture 图片	Usage 用量		PN for 2.5mm ²	PN for 3mm ²	PN for 4mm ²	PN for 6mm ²	PN for 6mm ² (ISO SPEC)	
		2POS	3POS	2.5mm ² 线 零件号	3mm ² 线 零件号	4mm ² 线 零件号	6mm ² 线 零件号	6mm ² 线零件号 (ISO 标准)	
Plug housing assy		1	1	*-2371035-*					(Definite PN see customer drawing)
4MM socket Contact		2	3	*-2349177-1	*-2349177-1	*-2349177-2	*-2349177-3	*-2349177-3	
Inner ferrule		2	3	2371242-1	2371242-4	2371242-2	2371242-3	2371242-3	
Outer ferrule		2	3	2371243-1					
Single wire seal		2	3	2371244-1	2428376-1	2371244-2	2371244-3	2428376-2	
Cable clip		2	3	2371245-1	1-2371245-1	2371245-2	2371245-3	1-2371245-2	
Dust cover (Optional)		1	1	2420809-1					

Table 4 shows the required components for assembly of HVA HD400 2POS & 3POS Plug Connector using KBE shield cable

Description 描述	Picture 图片	Usage 用量		PN for 2.5mm ²	PN for 4mm ²	PN for 6mm ²	
		2POS	3POS	2.5mm ² 线 零件号	4mm ² 线 零件号	6mm ² 线 零件号	
Plug housing assy		1	1	*-2371035-*			(Definite PN see customer drawing)
4MM socket Contact		2	3	*-2349177-1	*-2349177-2	*-2349177-3	
Inner ferrule		2	3	2371242-1	2371242-2	2371242-3	

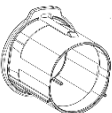
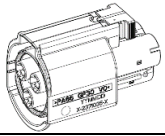
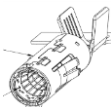

Application Specification

114-160093
Rev A10



Outer ferrule		2	3	2371243-1		
Single wire seal		2	3	2371244-1	2371244-2	2371244-3
Cable clip		2	3	2371245-1	2371245-2	2371245-3
Dust cover (Optional)		1	1	2420809-1		

Table 5 shows the required components for assembly of HVA HD400 2POS & 3POS Plug Connector using H&S shield cable





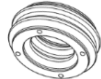

Description 描述	Picture 图片	Usage 用量		PN for H&S 2.5mm ² H&S 2.5mm ² 线零件号	PN for H&S 4mm ² H&S 4mm ² 线零件号
		2POS	3POS		
Plug housing assy		1	1	*-2371035- (Definite PN see customer drawing)	
4MM socket Contact		2	3	*-2349177-1	*-2349177-2
Inner ferrule		2	3	2371242-4	2371242-3
Outer ferrule		2	3	2371243-1	
Single wire seal		2	3	2428376-1	2428376-2
Cable clip		2	3	1-2371245-1	1-2371245-2
Dust cover (Optional)		1	1	2420809-1	

Table 6 shows the required components for assembly of HVA HD400 Blind Plug Connector

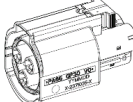

Blind Plug		1	1	2-2371035-1	
------------	---	---	---	-------------	--

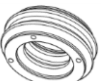
Table 7 shows the required components for assembly of HVA HD400 2POS & 3POS Header Connector

Description 描述	Picture 图片	Usage 用量		PN for 2.5mm ² 2.5mm ² 线零件号	PN for 3mm ² 3mm ² 线零件号	PN for 4mm ² 4mm ² 线零件号	PN for 6mm ² 6mm ² 线零件号
		2POS	3POS				
Header housing assy		1	1	*-2371113-*			
MCON1.2 terminal		2	2	5-1418758-3 for 0.35 mm ² wire 5-1418760-3 for 0.5 mm ² wire			
4MM PIN contact		2	3	*-2349180-1		*-2349180-2	*-2349180-3
Dust cover (Optional)		1	1	2389821-1			

3.2 Packaging and Storage 包装和贮存

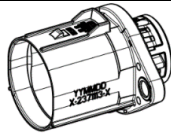
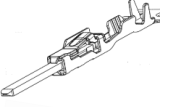
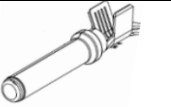
The products should be used on a “first in, first out” basis to avoid storage contamination, see latest valid customer drawings too.

为避免存储污染，产品应以“先进先出”的原则使用，也请参见最新的有效客户图纸。

4. APPLICATION TOOLS 应用工装

The Application tools are only valid for the specified cables at appendix. More tooling information can be obtained through a local TE Representative, or after purchase, by calling the product information Center.

应用工装仅对附录中的指定电缆有效。可通过当地TE代表获取更多工装信息，或者在购买后，拨打产品信息中心电话。

4.1 4MM round contact / 4MM 圆形端子

Table 8. Required application tools contact crimp

Application tools / 应用工装		
TE Applicator	Terminal P/N	Description
2375592	*-2349177-1	4MM socket contact crimp tool(for 2.5 / 3mm ² cable)
2375594	*-2349177-2	4MM socket contact crimp tool(for 4mm ² cable)
	*-2349177-3	4MM socket contact crimp tool(for 6mm ² cable)



Figure 1: 4MM contact crimping machine (4mm 端子压接设备)

Table 9. Extraction Tool

Application tools / 应用工装		
TE Applicator	Pin P/N	Description
2396476-1	*-2349177-*	Extraction Tool for Terminal

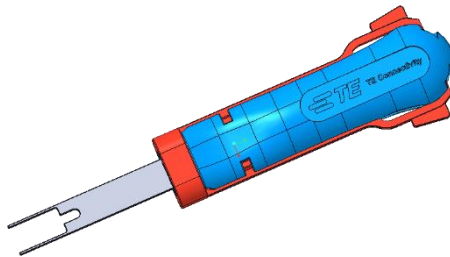

Figure 2: EXTRACTION TOOL (提取工具)

4.2 Shielding 屏蔽

The following table contains the required order numbers for application tools.
下表包含所需应用工装的订货号。

Table 10: Application tools

Application tools / 应用工装			
Wire Size	Crimping Machine	HV Die Holder P/N	HV Die Set P/N
2.5mm ² , 3mm ² , 4mm ² , 6mm ²	HF-20 / HV-20 2335500-1/-2 2348822-1/-2	2305470-1	2374311-1



Figure 3: Shielding crimping machine (屏蔽压接设备)

5. ASSEMBLY INSTRUCTIONS 组装说明

The following procedures show the details of the cable assembly and insertion instructions of the cable assembly into the plug housing subassembly. The processing is only valid for the specified cable at appendix and only these combinations have been validated by TE. Alternative cables may be used after ensuring performance through validation testing.

下述步骤显示了线缆组件的细节和线缆组件插入母端壳体子组件的插入说明。该制程仅对附录中的指定线缆有效，并且仅这样的组合通过TE验证。在通过验证测试性能之后，可以使用替代电缆。

5.1 Overview of all parts should be assembled 全部部件总览图

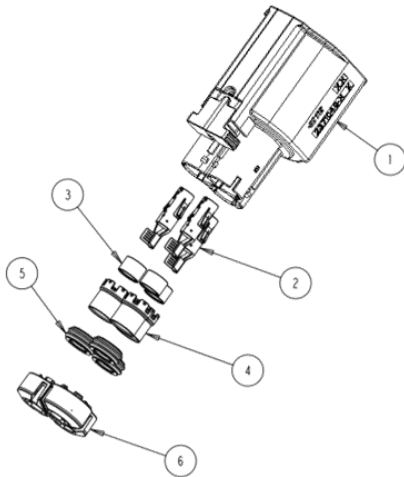

Table 11: Components cable assembly

2	3	CABLE CLIP	6
2	3	SINGLE WIRE SEAL	5
2	3	OUTER FERRULE	4
2	3	INNER FERRULE	3
2	3	DIA. 4MM SOCKET TERMINAL	2
1	1	2POS & 3POS, 4MM, PLUG HSG, ASSY, SEALED	1
2POS	3POS	DESCRIPTION	ITEM
QTY			

Figure 4: HVA HD400 2POS & 3POS Plug ASSY Explode Overview

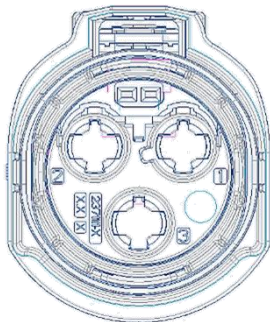

Figure5 : HVA HD400 2POS & 3POS Plug Overview

TPA is at pre-lock position

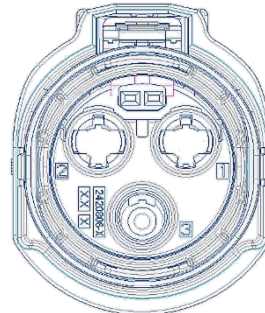

Figure 6: HVA HD400 Blind Plug Overview

TPA is at end-lock position

5.2 Cable components assembly 线缆组件组装

Safety information, avoid prolonged or repeated skin with conductor or shieldings (wear protective gloves). Please note, the procedure of assembly the shielded cable is provided in two documents, the following steps shows the assembly without contact processing.

安全提醒，避免皮肤长时间或重复与导体或屏蔽接触（戴防护手套）。
请注意，屏蔽线缆的组装步骤在两个文档中提供，以下组装步骤不包含端子。

5.2.1 Pre-load inner ferrule, single wire seal, cable clip 预组装屏蔽内环，线缆密封圈，导线卡夹

In order shown in figure 7, slide Cable seal assy and Shield crimp ferrule onto cable sheath, so that they are not in crimp work area.

按照图7所示的顺序，滑动密封组件和屏蔽内环套管到电缆护套上，使它们不在压接区域。

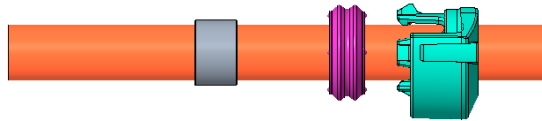

Figure 7: Before processing slide components onto cable

5.2.2 Cable strip 线缆裁切

Strip and remove outer sheath, screening braid (if present screening foil), inner sheath and conductor from the end as shown in figure 8.

如图8所示，从末端切开并去除外护套，屏蔽编织物（如果存在屏蔽箔），内护套和导体。

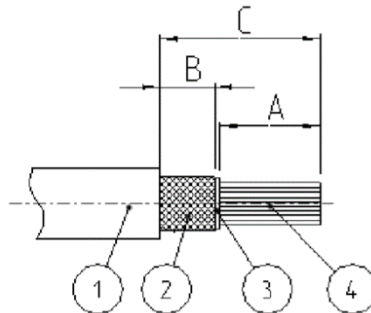

Figure 8: Cutting cable to length.

Stripping dimensions for exposing cable.



Attention: Cable sheath and shielding braid shall not be cut or broken during the cutting procedure.
注意：切割过程中不得切割或破坏电缆护套和屏蔽编织层。

Table 12: Cutting dimensions 剥线尺寸

(ID)	Cable Design	A [mm]	B [mm]	C [mm]
1	Outer sheath	--	--	16.8±0.5
2	Screening braid	--	(9)	--
3	Inner sheath	--	(11)	--
4	Conductor	5.5±0.5	--	--



Attention: Shielding braid shall not be broken.
注意：屏蔽编织不得被破坏

5.2.3 Contact crimp 端子压接

Prepare the cable, then crimp the contacts according to TE-Application specification 114-160038. The cable should be as defined in the SPEC or connector. Only wire and contacts that meet the requirements of the application specification can be used.

根据最新的泰科应用规范114-160038准备线缆裁切以及压接端子。电缆应是SPEC或连接器中定义的。只有满足该应用标准的导线及端子才能被使用。

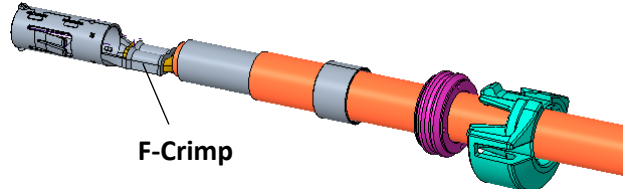

Figure 9: Contact crimp

5.2.4 Install inner ferrule 屏蔽内环的组装

Push the inner ferrule until the top surface flush with the cutting surface of outer jacket shown in figure 10. 如图10所示，将屏蔽内环推到内环顶面与外绝缘皮的切面平齐。

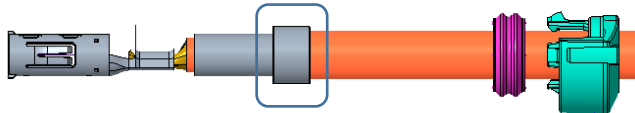

Figure 10: Put the inner ferrule in the final position

Raising screening braid equally over perimeter. 沿四周等长的翻起屏蔽编织。

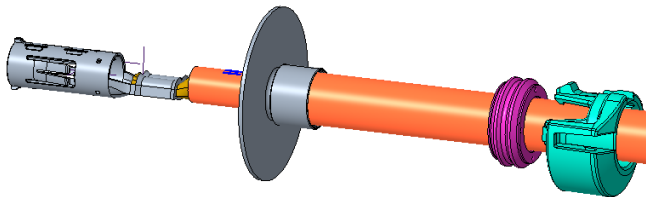

Figure 11: Raising screening braid

Turn over screening braid by lateral movement until cover the inner ferrule. 横向翻折屏蔽编织直到覆盖屏蔽内环。

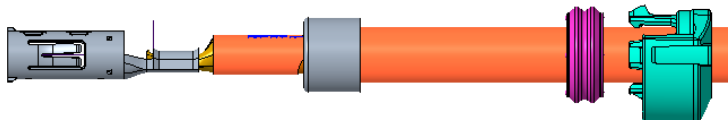

Figure 12: Turn over screening braid

5.2.5 Insert the outer ferrule 组装屏蔽外环

Insert the outer ferrule and keep the dimension between outer ferrule and terminal shown in figure 13. 如图所示，组装屏蔽外环并确保屏蔽外环与端子的距离尺寸公差满足图13要求。

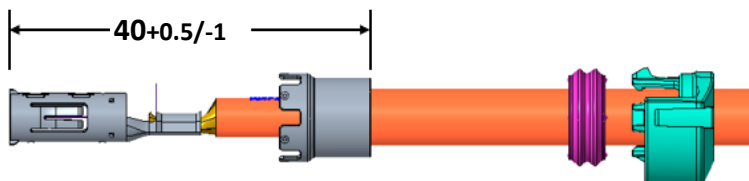

Figure 13: Insert the outer ferrule

5.2.6 Shielding crimp 屏蔽压接



It is essential that there are no mistakes in this step because there will be no chance to re-work the parts.
在这一步中没有错误是至关重要的，因为无法重新加工。

The following items at minimum must be inspected and verified before shield crimp process.

- All components are present, and parts are crimped in correct orientation and location
- No visible cracking of the shielding parts and no loose cable shield strands
- Hex crimp dimensions per figure 14, figure 15 and table 13
- Excess length of screening braid must be visible max 1mm
- Allocation of screening braid should be equal over perimeter

在屏蔽压接前，必须至少检查并验证以下项目：

- 所有部件完整，部件以正确的方向和位置进行压接
- 屏蔽部件没有明显的开裂，也没有松散的电缆屏蔽线
- 每个压接尺寸依据图14，图15和表13的六边形
- 屏蔽编织露出屏蔽环的长度必须小于1毫米
- 屏蔽编织应该均匀分配在四周

Shield crimp specification
屏蔽压接规范

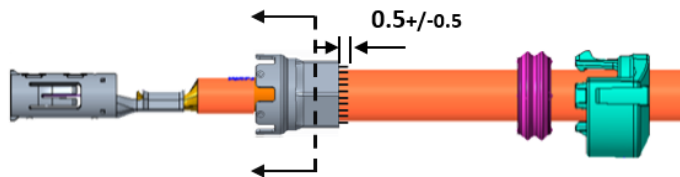

Figure 14: Crimped ferrule

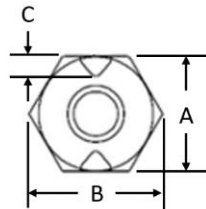

Figure 15: Cross section X-X: Shielding crimp section

Table 13: Shield crimped dimensions (may be affected by the wire such as material, physical size. Below table value is recommended that based on KBE, FORCE and H&S wire.)

Cable Type	Cross Section (mm ²)	A ± 0.1 (mm)	B Max. (mm)	C (mm)
KBE/FORCE/H&S	2.5	7.75	9.10	(0.75)
FORCE	3	7.70	9.10	(0.75)
KBE/FORCE/H&S	4	7.70	9.10	(0.75)
KBE/FORCE	6	7.70	9.10	(0.75)

5.3 Plug Housing assy 母端壳体组装

5.3.1 Insert cable assembly into the Plug Housing 线缆组件装入母端壳体

Note the alignment of plug housing subassembly and cable assembly as shown figure 16.
注意，如图16所示，线缆组件与母端壳体组件方向对齐。

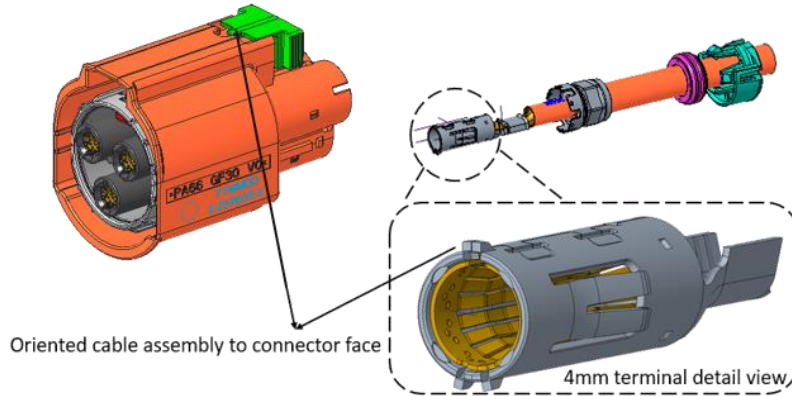

Figure 16: Oriented cable assembly to housing

Insert aligned the cable assembly into the plug subassembly until it stops against the inside of the housing and it makes "Click".

将线缆组件插入母端壳体组件，直到抵住外壳内部并发出“咔嗒”声。

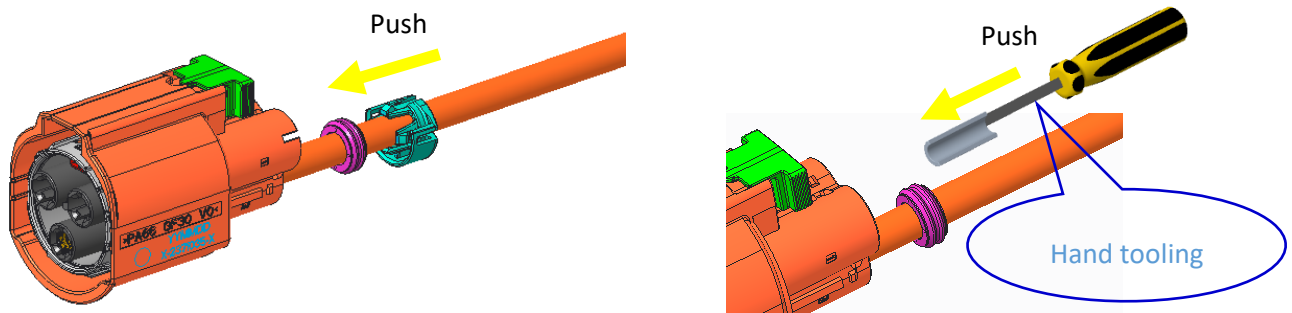

Figure 17: Insert cable assembly into the plug housing

5.3.2 Assemble cable seal assembly 组装线材密封组件

Slide the cable clip with single wire seal onto plug housing until it is fully locked and makes 'click', recommend to apply hand tooling to push SWS into housing.

The following items at minimum must be inspected and verified:

- Visual examination of correct orientation of single wire seal before sliding the cable clip.
- Visual examination of correct assembling cable clip into housing after assembly, make sure both latches of each clip were locked.

滑动线缆卡夹将线缆密封圈一起推到母端壳体处直到完全扣住并发出“咔嗒”声,建议使用手工具推密封圈进塑壳内。

必须至少检查并验证以下项目:

滑动线缆卡夹前目视检查线缆密封圈是否外翻,确认密封圈没有外翻后再推动线缆卡夹。

组装完成后目视检查线缆卡夹是否正确组装到主体外壳上,卡夹上的两个弹片必须都扣住主体。



Figure 18: Assemble cable seal orientation

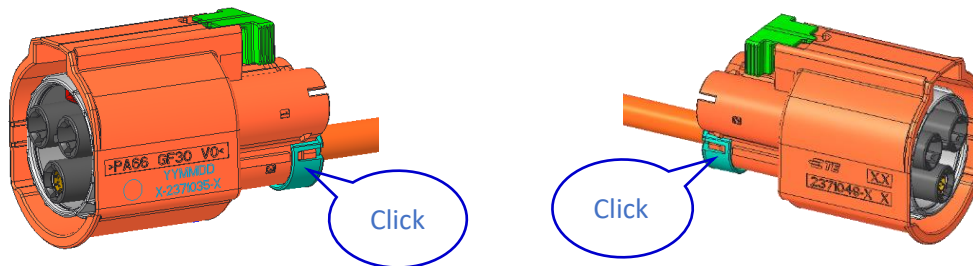

Figure 19: Assemble cable seal assy

Assemble three cable assy for 3POS connector application; assemble two cable assy for 2POS connector application.

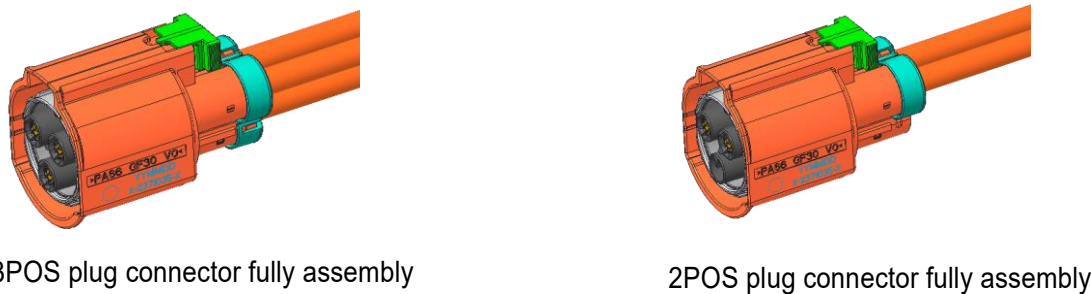

Figure 20: Fully Assemble cable assy to housing

5.3.3 Press TPA to end-lock position TPA 压到终锁位

Please note, after all cable assy were fully assembled, TPA should be pressed until it stops against the plug housing. Pressing smoothly indicates that the cable assy has been assembled in the correct position, otherwise the cable assembly and TPA status should be checked.

请注意，线缆组件安装完成后，下压TPA到终止位置。下压顺利说明线缆组件已安装到正确位置，反之需检查线缆组件和TPA状态。

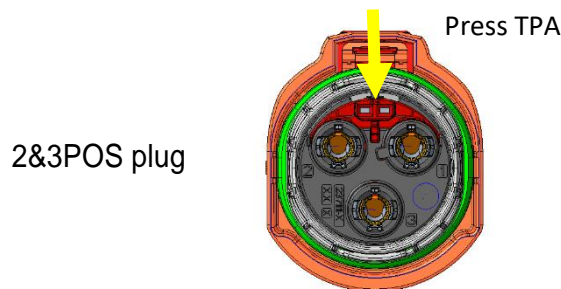

Figure 21: Press TPA to final lock position

6. FINAL EXAMINATION 终检

6.1 Visual Examination 外观检查

After processing the connector assembly has to be checked of completeness, correctness acc. to customer drawings and free of damage.

在装配连接器后，必须根据客户图纸进行完整性、正确性检查，且不能损坏。

6.2 Electrical Tests 电气测试

Electrical characteristic values according product specification TE-108-160170 / chapter 3.4 are ensured by applicator. The test parameter should be not exceeding the values shown in point 3.4/ TE-108-160170.

使用方依据产品规范TE-108-160170第3.4章保证电气特性。测试参数不应超出规范3.4章的值。

7. HEADER ASSY AND PLUG ASSY MATING/ UNMATING INSTRUCTIONS 公母端安装说明

7.1 Header assy and plug assy mating 公母端连接器互配

Delivery condition with CPA are in pre-lock position.
Visual examination of CPA position before mating with header.
CPA的交付条件是处于预锁位置。
公母端连接器互配前目视确认CPA的位置。

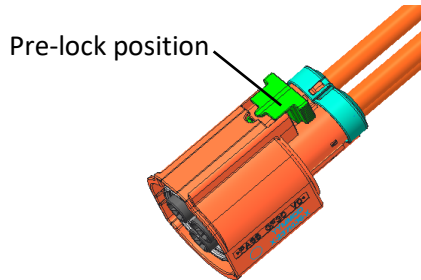

Figure 22: Delivery condition – CPA in pre-lock position

Mating plug with header until it is fully locked and makes 'click'.
将公母头连接器对配直到完全扣住并发出“咔哒”声。

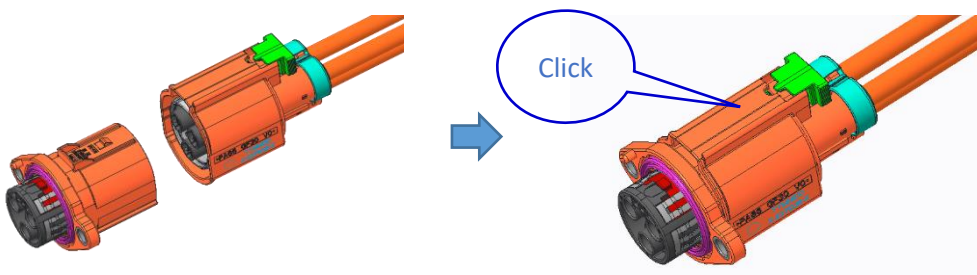

Figure 23: Header assy and plug assy mating condition

Please note, after header and plug are fully assembled, CPA should be pushed until it stops against the plug housing.

Pushing smoothly indicates that header and plug have been assembled in the correct position, otherwise the mating condition and CPA status should be checked.

请注意，公母头连接器对配完成后，推动CPA到终止位置。推动顺利说明公母头连接器已对配到正确位置，反之需检查公母头连接器的对配状态和CPA状态。

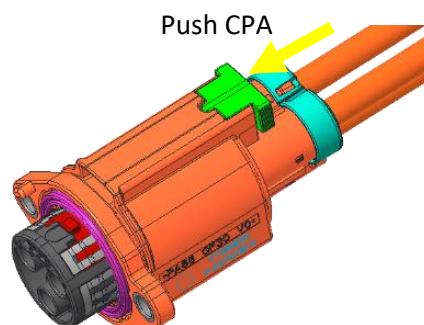

Figure 24: Push CPA to final lock position

7.2 Header assy and plug assy un-mating 公母端连接器解除互配

Pull the CPA until it gets to pre-lock position.
将CPA拉出到预锁位置。

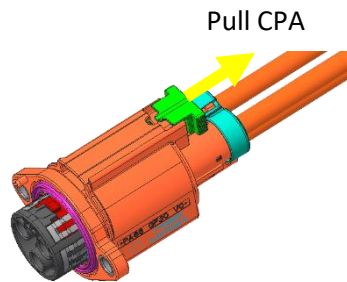

Figure 25: Pull CPA to pre-lock position.

Fully depress CPA while pulling the plug connector until it is fully separated from the header assembly.
按压CPA，同时将母头连接器拔出公端连接器直到完全分离。

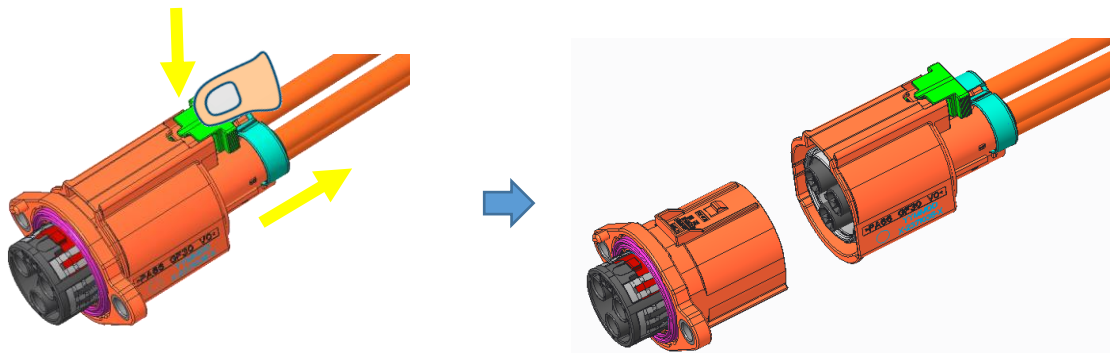

Figure 26: Header assy and plug assy un-mating condition.

8. APPENDIX 附录

8.1 Data sheets 数据表

8.1.1 KBE shield cable 2.5 / 4 / 6mm² KBE 2.5 / 4 / 6mm²屏蔽线

KBE: No. FHRL2GCB2G 6mm² and No. FHRL91XCB91X 2.5mm²、4mm² shield cable for HVA HD400 connector.
KBE: HVA HD400母端连接器采用物料编号FHRL91XCB91X 2.5mm²、4mm²；FHRL2GCB2G 6mm²屏蔽线

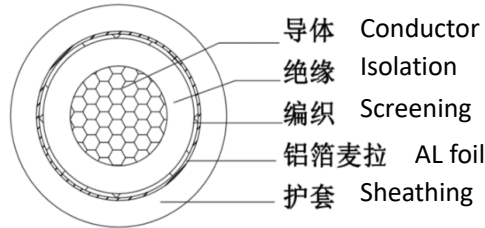

Region	Outer diameter(mm)		
	2.5mm ²	4mm ²	6mm ²
Conductor	MAX. 2.2	MAX. 2.8	Max. 3.4
Isolation	3-0.3	3.7-0.3	4.3-0.3
Sheathing	4.7-0.5	5.8-0.5	6.5-0.5

Table 14: KBE shield cable

8.1.2 FORCE shield cable 2.5 / 3 / 4 / 6mm² FORCE 2.5 / 3 / 4 / 6mm²屏蔽线

FORCE: No. FHRL91XCB91X 2.5mm²、4 mm²、6mm² (ISO/LV) and LV-QBJP21-D 3 mm² shield cable for HVA HD400 connector.

FORCE: HVA HD400 母端连接器采用物料编号 FHRL91XCB91X 2.5mm²、4 mm²、6mm²(ISO/LV) 和物料编号 LV-QBJP21-D 3 mm²的屏蔽线。

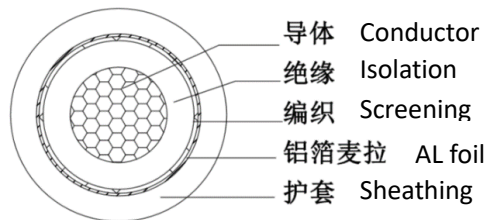

Region	Outer diameter(mm)				
	2.5mm ²	3mm ²	4mm ²	6mm ²	6mm ² (ISO)
Conductor	MAX. 2.2	MAX. 2.4	MAX. 2.8	Max. 3.4	Max. 3.4
Isolation	3-0.3	3.4-0.3	3.7-0.3	4.3-0.3	4.3-0.3
Sheathing	4.7-0.5	5.4-0.4	5.8-0.5	6.5-0.5	6.1-0.6

Table 15: FORCE shield cable

8.1.3 H&S shield cable 2.5 / 4mm² H&S 2.5 / 4mm²屏蔽线

H&S: No. RADOX screened single core cable (FHRL91XC13X and FHRL4GC13X) 2.5mm²、4mm² shield cable for HVA HD400 connector.

H&S: HVA HD400 母端连接器采用物料编号 RADOX screened single core cable (FHRL91XC13X and FHRL4GC13X) 2.5mm²、4mm²的屏蔽线。

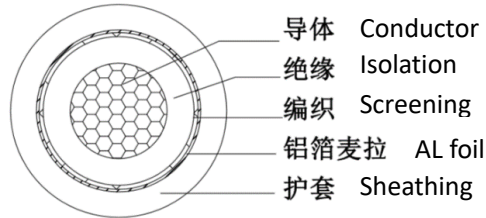

Region	Outer diameter(mm)	
	2.5mm ²	4mm ²
Conductor	MAX. 2.0	MAX. 2.5
Isolation	3-0.3	3.7-0.3
Sheathing	5.2-0.4	6.0-0.4

Table 16: H&S shield cable

REV	DESCRIPTION CHANGE	RESPONSIBLE	DATE
A	New document	Z.C	23JUL2021
A1	Add pictures and PNs	S.W	17FEB2023
A2	Change the text content of ASSEMBLY INSTRUCTIONS	S.W	03JUL2023
A3	Added blind plug information	S.W	05JUL2023
A4	Add 3sq/ISO 6sq cable information	S.W	23AUG2023
A5	Change the socket contact PN	S.W	29AUG2023
A6	Add shield crimp C dimension	H.P	08DEC2023
A7	Change the blind plug information	S.W	29JAN2023
A8	Add the H&S shield cable	S.W	22MAR2024
A9	Modify the component information	S.W	22AUG2024
A10	Modify the shield crimped dimensions	S.W	13SEP2024