2-8pos. MCON 1.2 – LL Connector, Sealed with SWS

TABLE OF CONTENTS

1 GENERAL

- 1.1 PURPOSE
- 1.2 CUSTOMER DRAWINGS
- 1.3 DELIVERY CONDITION
 - 1.3.1 CONNECTORS WITHOUT CPA
 - 1.3.2 CONNECTORS WITH CPA
 - 1.3.3 TERMINALS
 - 1.3.4 CONNECTORS ARE BULK PACKAGED
 - 1.3.5 DUE TO BULK PACKAGING, IT IS POSSIBLE FOR THE RETAINER TO SHIFT DURING TRANSPORTATION
 - 1.3.6 SHOULD THIS OCCUR, SHIFT RETAINER TO PRE-LOCK POSITION AS DIMENSIONED ON THE CUSTOMER DRAWING PRIOR TO TERMINAL LOADING (Ref dim 2mm)

2 CONNECTOR 2 TO 8POS, MCON 1.2 WITH SWS

- 2.1 ASSEMBLY OF THE CONNECTORS (VALID FOR ALL PIN COUNT VERSIONS)
- 2.2 TERMINAL INSERTION INSTRUCTIONS
- 2.3 APPLICABLE WIRES
- 2.4 RETAINER ENGAGE INSTRUCTIONS
- 2.5 RETAINER DISENGAGE INSTRUCTIONS
- 2.6 TERMINAL REMOVAL INSTRUCTIONS

3 MATING AND UNMATING OF THE CONNECTORS

- 3.1 MATING WITH CPA
- 3.2 UNMATING WITH CPA
- 3.3 MATING WITHOUT CPA
- 3.4 UNMATING WITHOUT CPA

4. DOCUMENT CHANGE HISTORY

1 GENERAL

1.1 PURPOSE

THIS SPECIFICATION DESCRIBES HOW TO HANDLE THE COMPONENTS OF THE CONNECTORS 2- TO 8 POS., MCON 1.2 WITH SWS (Single Wire Seal)

1.2 CUSTOMER DRAWINGS

THIS APPLICATION SPECIFICATION IS BASED ON THE LATEST VALID CUSTOMER DRAWINGS.

INTERFACE SPECIFICATION:
SEE TYCO ELECTRONICS FRAME SPECIFICATION: **114-18679-3**

1.3 DELIVERY CONDITION

1.3.1 CONNECTORS WITHOUT CPA

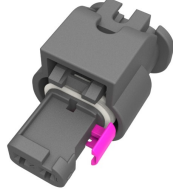
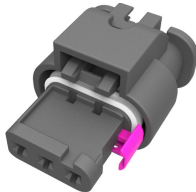
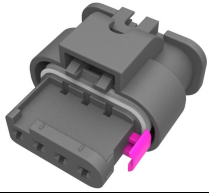
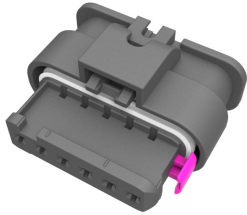
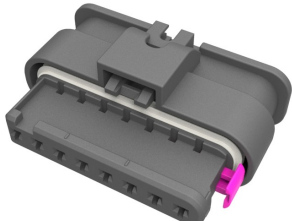
| | |
|--------------------------------------|---|
| <p>2pos. MCON 1.2 – LL Connector</p> |  |
| <p>3pos. MCON 1.2 – LL Connector</p> |  |
| <p>4pos. MCON 1.2 – LL Connector</p> |  |
| <p>5pos. MCON 1.2 – LL Connector</p> |  |
| <p>6pos. MCON 1.2 – LL Connector</p> |  |
| <p>8pos. MCON 1.2 – LL Connector</p> |  |

1.3.2 CONNECTORS WITH CPA

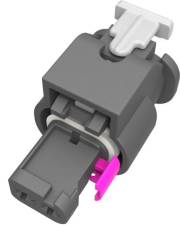
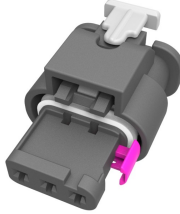
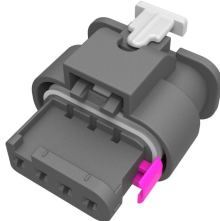
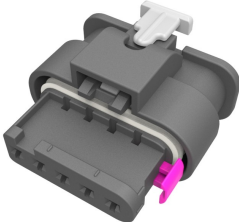
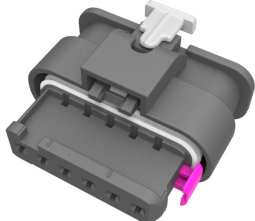
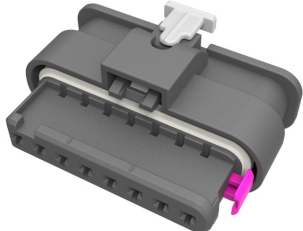
| | |
|--------------------------------------|---|
| <p>2pos. MCON 1.2 – LL Connector</p> |  |
| <p>3pos. MCON 1.2 – LL Connector</p> |  |
| <p>4pos. MCON 1.2 – LL Connector</p> |  |
| <p>5pos. MCON 1.2 – LL Connector</p> |  |
| <p>6pos. MCON 1.2 – LL Connector</p> |  |
| <p>8pos. MCON 1.2 – LL Connector</p> |  |

1.3.3 TERMINALS

| | | |
|--------------------------------|--|---|
| <p>MCON 1.2 – LL Terminals</p> | <p>CUSTOMER DRAWING 1452674</p> <p>APPLICATION SPEC. 114-18464</p> <p>PRODUCT SPEC. 108-18782</p> |  |
|--------------------------------|--|---|

2 CONNECTOR 2 TO 8POS, MCON 1.2. WITH SWS

2.1 ASSEMBLY OF THE CONNECTORS (VALID FOR ALL PIN COUNT VERSIONS)

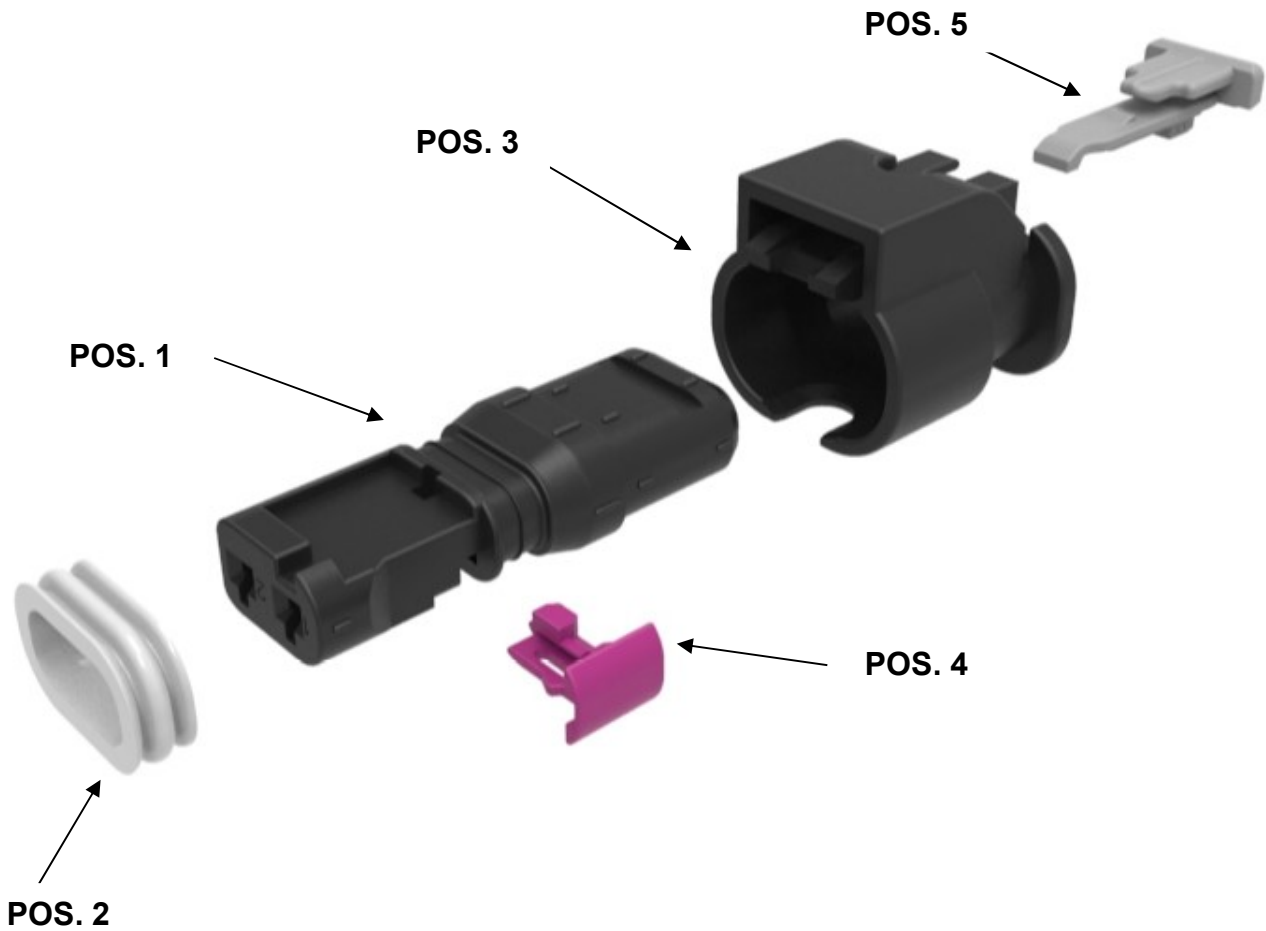

POS. 1: Receptacle Housing

POS. 2: Peripheral Seal

POS. 3: Protection Cover

POS. 4: Retainer

POS. 5: CPA

2.2 TERMINAL INSERTION INSTRUCTIONS

INSERTION DIRECTION

ORIENTATION FEATURE OF THE TERMINAL.



INSERT TERMINAL UNTIL AN AUDIBLE CLICK IS HEARD OR THE LOCK IS FELT

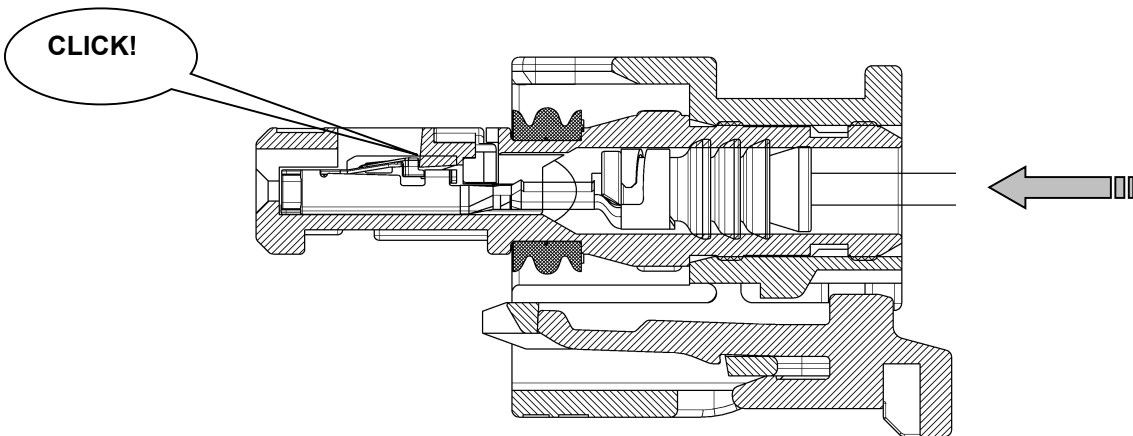

IN CASE OF 1mm² CABLE WITH 180° CABLE EXIT, SWS PROTRUSION DURING TERMINAL INSERTION OF **MAX. 0.5mm** IS ALLOWED. THIS IS ALLOWED FOR THE SEAL COLLAR ONLY. THE SEALING LIPS MUST REMAIN IN THE CONTACT CAVITY AT ALL TIMES.

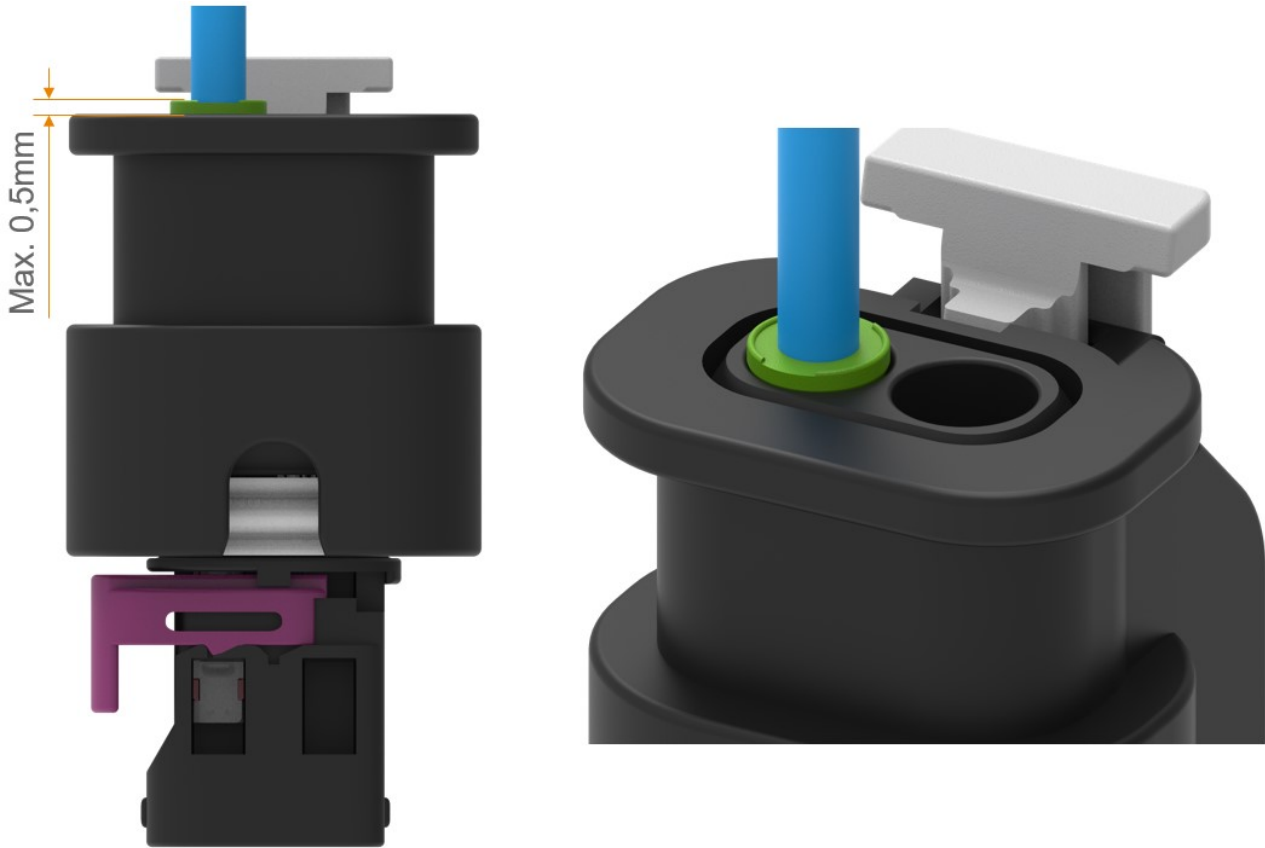

2.3 APPLICABLE WIRES

SEE ALSO THE CUSTOMER DRAWINGS **1452674**

| Accessories | | | | | | | |
|---------------------|---------|-----------------|--------------|------------------|-----------|--------------------------|------|
| Wire | | | Part numbers | | | | |
| Type (DIN 76772) | Ø | mm ² | MCON 1.2 LL | Single wire seal | | Blind plug PN / Color | |
| FLR & ACW | 1.2-1.4 | 0.35 | 7-1452665-3 | Yellow | 967067-2 | 967056-1 | Blue |
| | 1.4-1.6 | 0.50 | 7-1452668-3 | Green | 967067-1 | | |
| | 1.7-1.9 | 0.75 | 7-1452668-3 | Green | 967067-1 | | |
| | 1.9-2.1 | 1.00 | 7-1452671-3 | Green | 967067-1 | | |
| | 2.2-2.4 | 1,50 | 7-1452671-3 | Green | 2287497-1 | | |

2.4 RETAINER ENGAGE INSTRUCTIONS

INSERTION OF THE RETAINER TO END-LOCKED POSITION

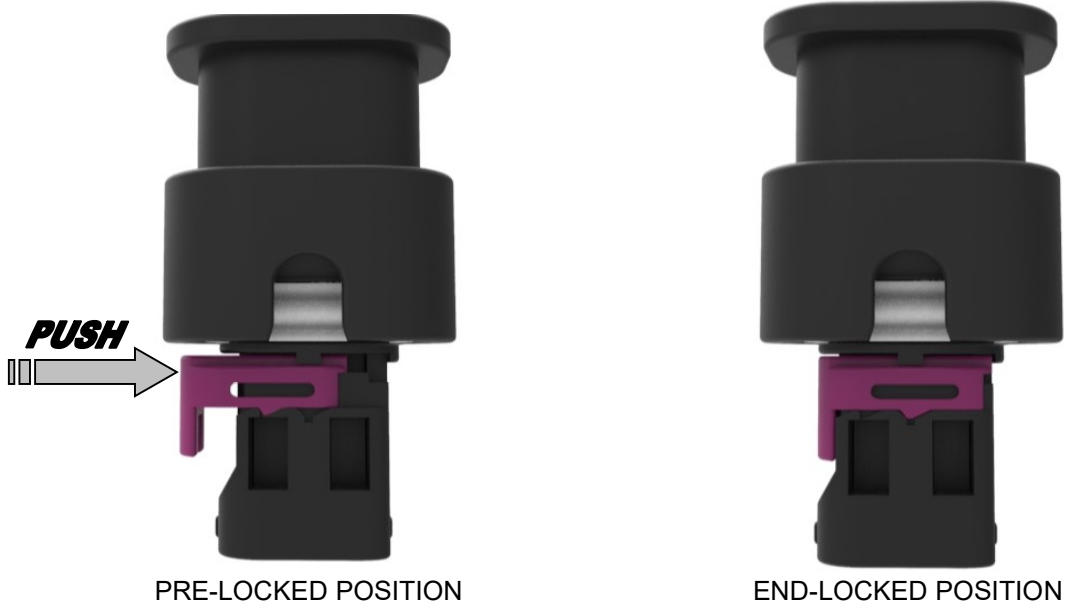

2.5 RETAINER DISENGAGE INSTRUCTIONS

PLACE THE EXTRACTION TOOL (E.G. SCREWDRIVER) IN THE SHOWN PLACE TO DISENGAGE THE RETAINER.



RETAINER ONLY TO MOVE TO THE PRE-LOCKED POSITION

2.6 TERMINAL REMOVAL INSTRUCTIONS

INSERT THE EXTRACTION TOOL (TYCO-PN: 5-1579007-3) TO LOCKING HOOK. THE TERMINALS CAN BE REMOVED BY PULLING THE CABLE AND SIMULTAENEOUSLY BENDING THE LOCKING HOOK

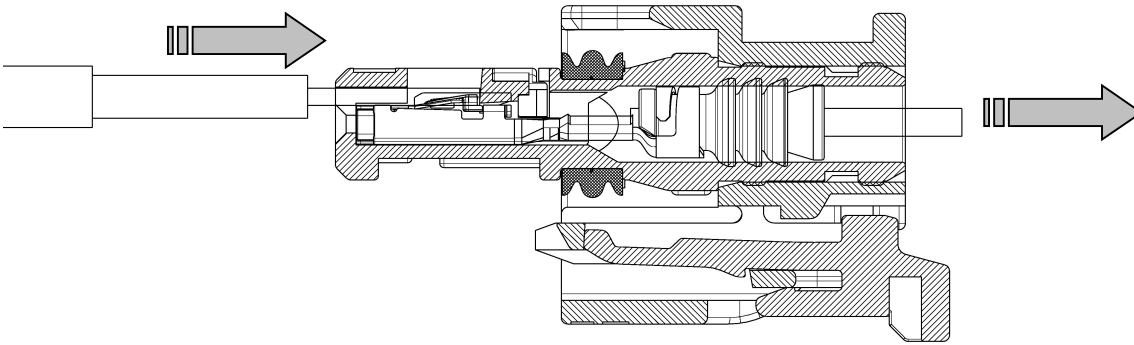

3. MATING AND UNMATING OF THE CONNECTORS

3.1 MATING WITH CPA

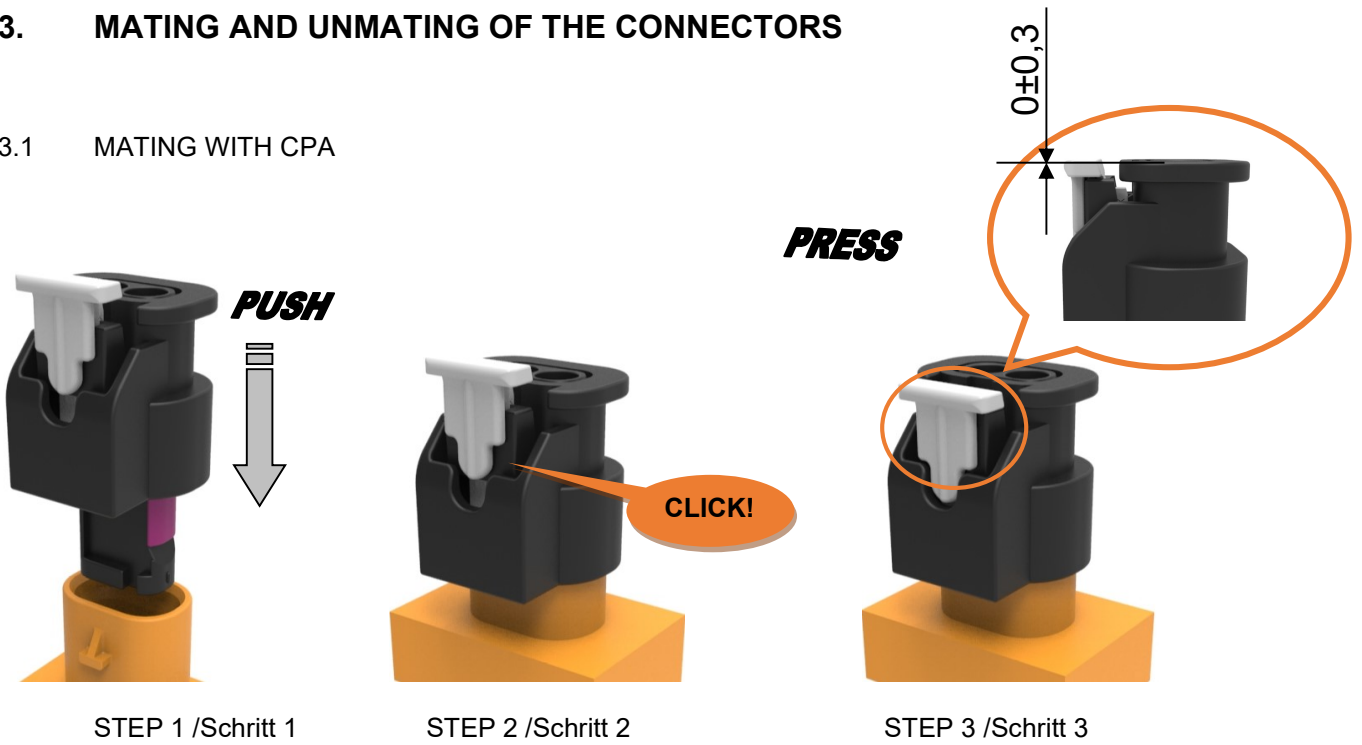

3.2 UNMATING WITH CPA

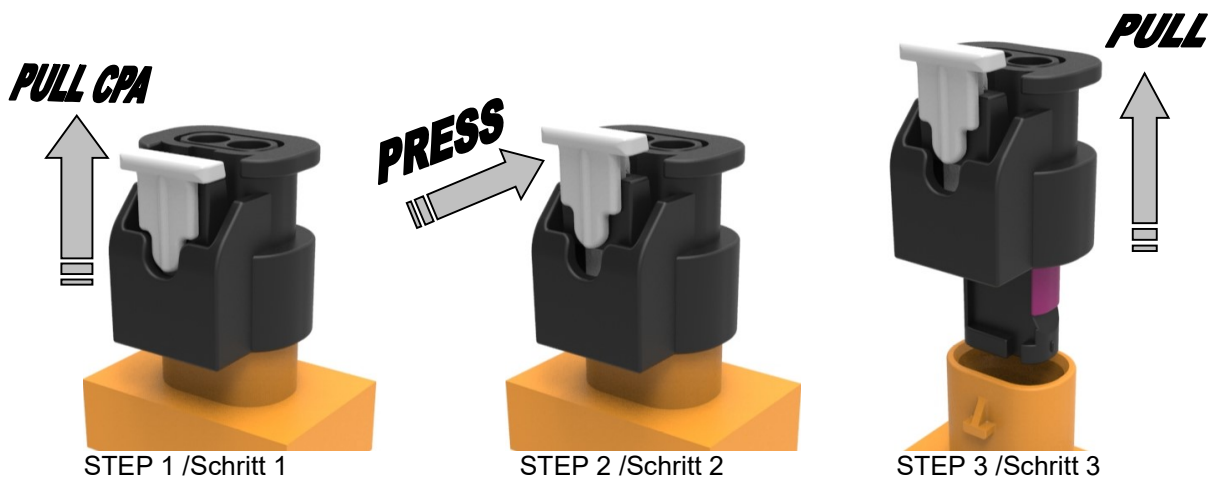

3.3 MATING WITHOUT CPA

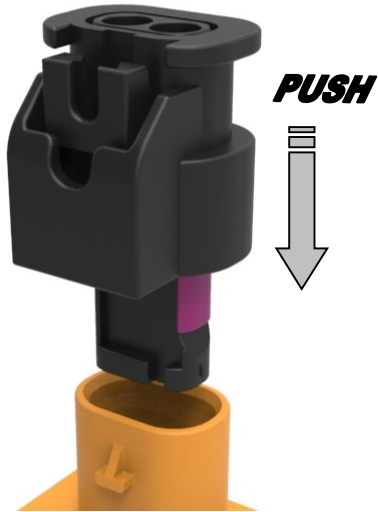

STEP 1

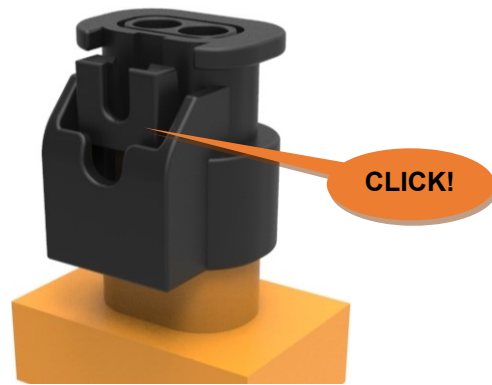

STEP 2

3.4 UNMATING WITHOUT CPA

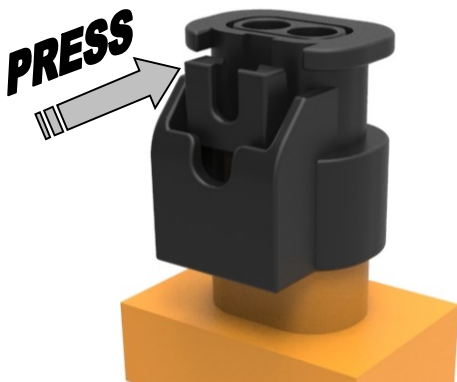

STEP 1

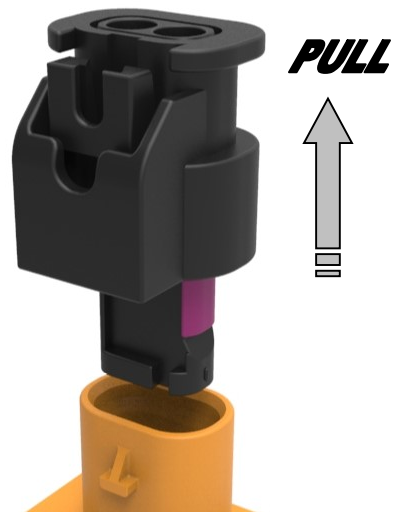

STEP 2

DOCUMENT CHANGE HISTORY

| | NAME | DATE | REV | CHANGE |
|-----------------------|-------------|-------------|------------|--|
| CHANGE HISTORY | - | 18SEP2007 | A | Initial document |
| | Sz. Nemes | 11AUG2013 | A1 | Point 1.3.3 - 1.3.6 added |
| | Sz. Nemes | 26SEP2019 | A2 | Cosmetical update Wire insulation info added for 1,5mm ² cable |
| | Sz. Nemes | 13DEC2023 | A3 | Information on SWS protrusion added |
| | | | | |