

89X1N Series WIRELESS VIBRATION SENSOR USER MANUAL

Doc# 20023687-33

Revision 2



REVISIONS

DATE	Revision	Change Description	Prepared by	Approver
11/01/2022	Rev 0.1	Initial draft NEW Version		PRS
12/14/2023	Rev 1	Add block diagram, remove watermark, change TCPN from 20023687-26 to 20023687-33		PRS
01/02/2024	Rev 2	Add Radiation Exposure Statement content		PRS

Contents

1. Introduction	4
2. Block Diagram	4
3. General Description	5
3.1. DEVICE START-UP	5
3.2. MODES OF OPERATION.....	6
3.3. DATA COLLECTION	6
3.4. DATA PROCESSING	7
3.5. COMMUNICATION – LoRaWAN™	9
3.6. BLUETOOTH® LOW ENERGY.....	10
4. Magnetic Switch.....	11
5. LED Indicator	12
5.1. LoRaWAN™ Join request examples.....	12
5.2. LoRaWAN™ Uplink transmission Examples	13
6. Presets.....	14
6.1. MANAGING PRESETS.....	15
6.2. ROTATING PRESET MODE	16
7. Battery.....	17
7.1. BATTERY TYPE	17
7.2. BATTERY LIFE.....	17
7.3. BATTERY REPLACEMENT	18
7.4. BATTERY ESTIMATION ALGORITHM.....	18
7.4.1. CURRENT CONSUMPTION PROFILES.....	19
8. Dimensions.....	20
9. Mounting Considerations & Accessories	20
10. Certifications & Compliances	22
11. REGULATORY STATEMENTS	22
11.1. FCC and IC	22
11.2. EU Statement of Conformity.....	22
12. Ordering Information	25

1. Introduction

TE Connectivity’s 89X1N Series Wireless Vibration Sensor is composed of the 8931N and 8911N Family of models. Models in series are either 1-axis (8911N) or 3-axis (8931N) accelerometer, and combine a data collector, and a radio into one compact, battery-operated device that measures both vibration and temperature data. These sensors were designed for harsh environment and comes with the ATEX certification.

Model 8911N and 8931 wireless vibration sensors use the LoRaWAN™ communication protocol, offering a simple, reliable, and secure means of expanding condition-based maintenance into plant areas where the cost to install wired systems is prohibitive, making data available to existing process control and information systems. In addition to that, they offer a Bluetooth Low Energy interface to ease the embedded settings configuration at the sensor installation.

These sensors incorporate a piezo-electric accelerometer which offers a wide bandwidth to >15kHz, outstanding measurement resolution and superior long-term stability compared to design using MEMS solutions.

All models contain digital signal processing capability that provides an FFT analysis of the sensed vibration. The output data describes the center frequency, peak value, bandwidth, and percent of the total spectral content for the eight most significant acceleration peaks in the vibration signal.

Because of this feature, the 89X1N series directly provides the data most needed to plot trends and monitor changes in the performance and condition of factory machinery.

2. Block Diagram

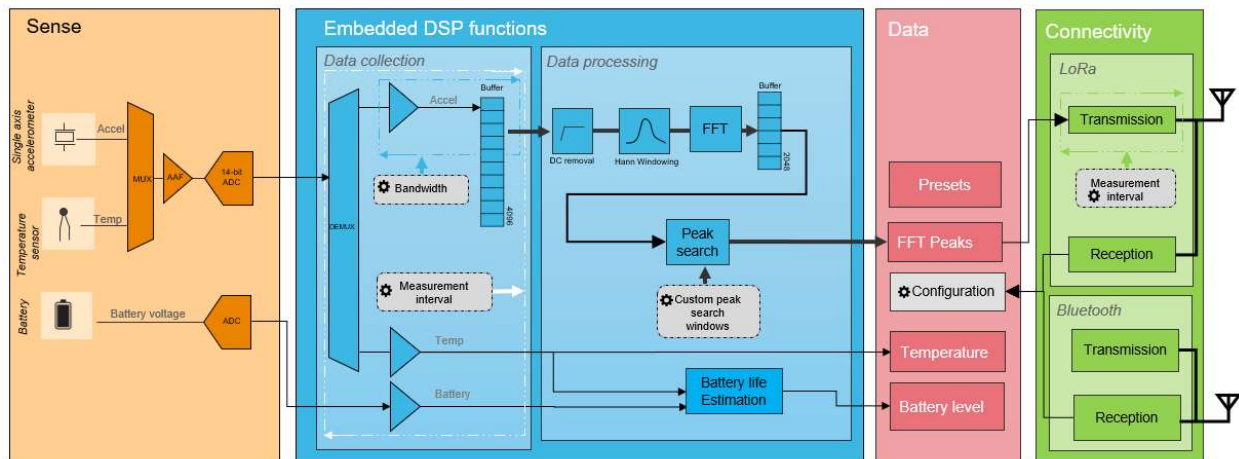

3. General Description

The 89X1N Series Wireless Vibration Sensor has two BLE modes and one LoRaWAN™ mode:

- BLE advertising mode - Starts automatically when the battery is inserted. Advertising occurs at a rate of once per second.
- BLE connected (pairing) mode – After each advertisement, the user can initiate a change to connected mode. When connected, the user can configure the device and use other special features.
- LoRaWAN™ mode – After being configured in the BLE connected mode, LoRa is used to communicate with an external network.

3.1. DEVICE START-UP

- 1) Insert battery (refer to Installation Manual – Doc #20023687-24). On-board LED will flash once upon proper installation.
- 2) The sensor will begin BLE advertising at the rate of once per second.
- 3) After the first advertisement, the sensor will transmit a “Join Request” on the LoRa frequency. If successful, sensor data will be transmitted via uplink messages at intervals determined by the sensor default settings. BLE features are disabled during the LoRa communications.
- 4) Once LoRa communications are complete, the sensor will revert back to BLE advertising.
- 5) During advertising, the user can respond and establish the BLE “Connected” (or pairing) mode. While in Connected mode, the user can configure all sensor variables such as LoRa transmit interval and FFT features.
- 6) At sixty minutes after start-up, all BLE features are disabled, and data communications will proceed via the LoRa connection. The communication parameters will follow the settings established during the BLE Connected mode time. The sensor configuration can be adjusted via LoRa communications just as it was during the initial sixty-minute BLE time.
- 7) At any time after the initial sixty-minute BLE mode operation, a new sixty-minute period can be initiated by placing a magnet close to the magnet symbol on the sensor housing. Depending on the how the magnet is applied, either the new BLE mode can be initiated, or the sensor can be reset. See section 4 regarding the Magnetic Switch.

3.2. MODES OF OPERATION

The device operation can be summarized by the following state machine diagram.

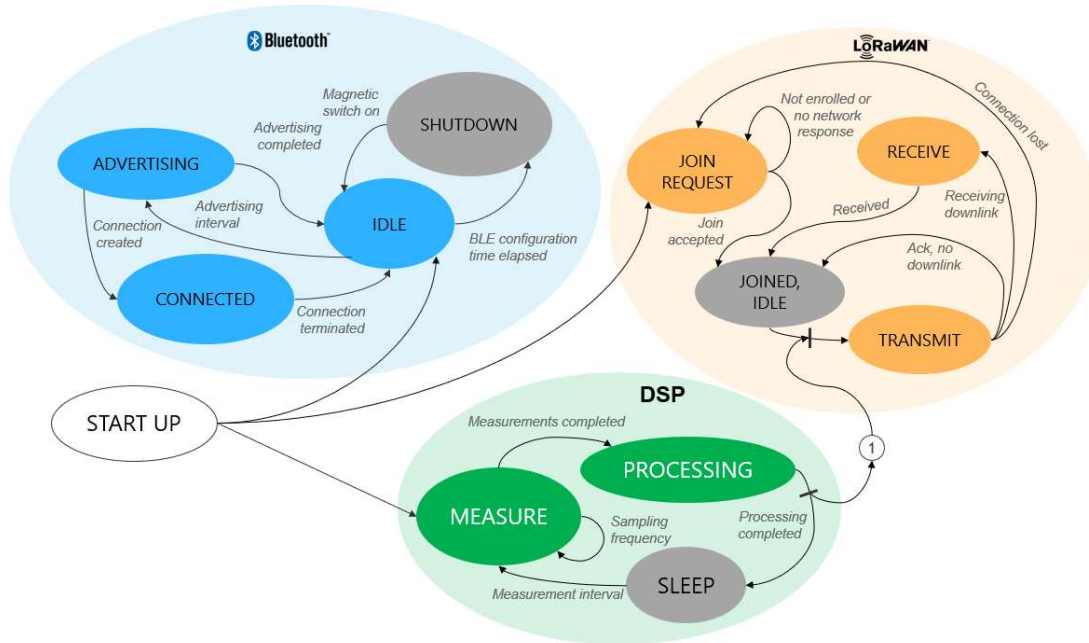

3.3. DATA COLLECTION

Sensor measurements are performed and transmitted at a configurable interval from 1 min up to 24 hours. This is driven by the *Measurement interval* parameter.

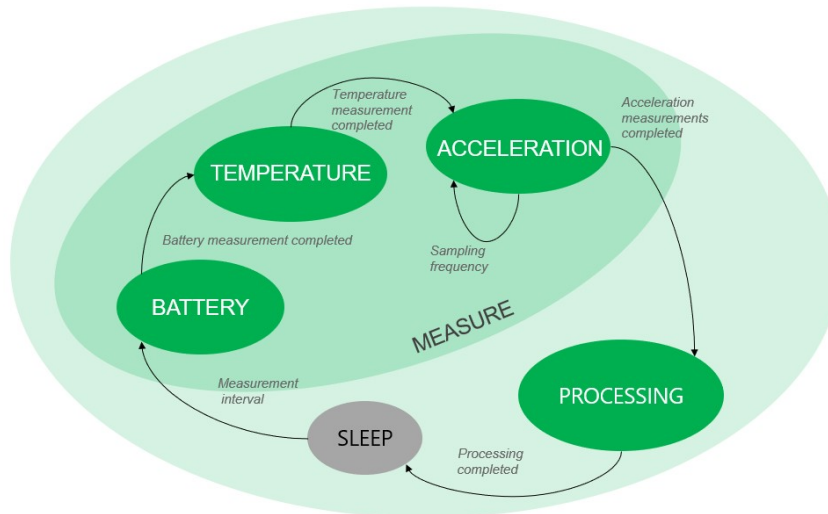

Upon wake-up, the device powers the sensing element and waits for about 3 seconds to let the accelerometer boot and stabilize its output.

A measurement consists of reading the battery level, temperature, and a set of 4096 acceleration values at a configurable rate.

Data	Unit	Accessibility
Battery level	%	LoRaWAN™, BLE
Temperature	°C	LoRaWAN™, BLE
Acceleration	mg	None

3.4. DATA PROCESSING

The data processing signal chain transforms the acceleration raw data into frequency peaks.

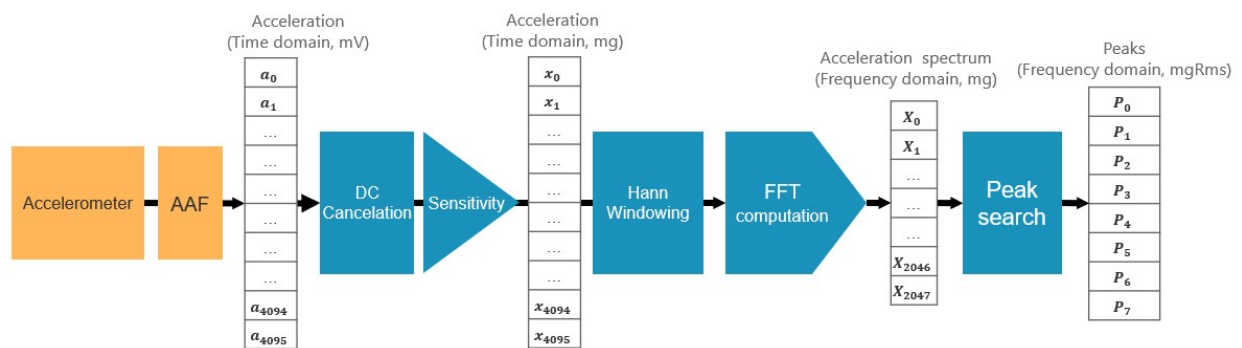

Acceleration data is collected at a chosen sampling frequency. Raw data passes through an anti-aliasing filter. Once a set of acceleration readings is measured (4096 points), the embedded algorithm removes the DC signal (to remove the bias voltage of the sensing element) and multiplies the results by the sensor element calibration sensitivity (mV/g). The algorithm then applies a Hann window to the signal and converts it into a normalized FFT spectrum. Finally, a peak search algorithm extracts the most significant peaks from the spectrum.

Certain data is saved for each of the peaks:

Parameter	Description
Peak Frequency	Frequency of the peak (Hz)
Peak RMS magnitude	Single frequency peak PMS magnitude (g)
Ratio	Ratio of energy. Maximum peak magnitude plus associated bins divided by total spectrum energy.

Note that only “Peak values” are accessible by the user. Raw data and raw FFT spectrum are stored for internal computation and are not available outside the sensor.

From this point, several customer defined options are available to further process the data into useful output information.

The customer can establish and configure up to eight windows across the FFT spectrum. For each window, the user can configure the following parameters:

Parameter	Description	
Peak number	Number of peaks to be found (0 to 24)	
Number of bins	Number of bins around the main beam to be integrated into the ratio output. This parameter can be used to filter side lobes and avoid multiple peaks found around the same frequency	
Minimum frequency	Minimum frequency of the search window	These define the bandwidth of each window
Maximum frequency	Maximum frequency of the search window	

By default, no windows have been established or configured. The peak search covers the full spectrum.

Fast Fourier Transform Spectrum

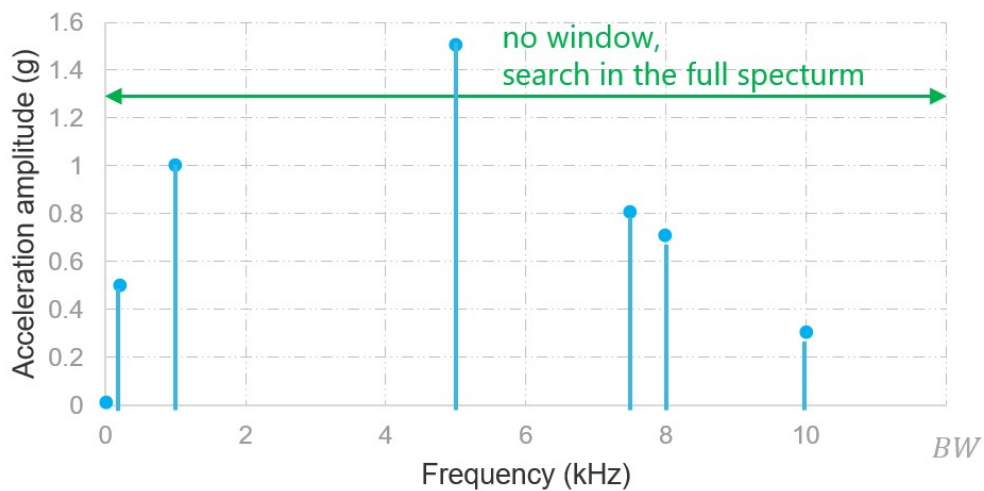

Typical FFT spectrum showing the highest eight peaks.

It is possible to program up to 8 custom windows to define several regions of interest. Any peak outside the windows will be ignored.

Fast Fourier Transform Spectrum

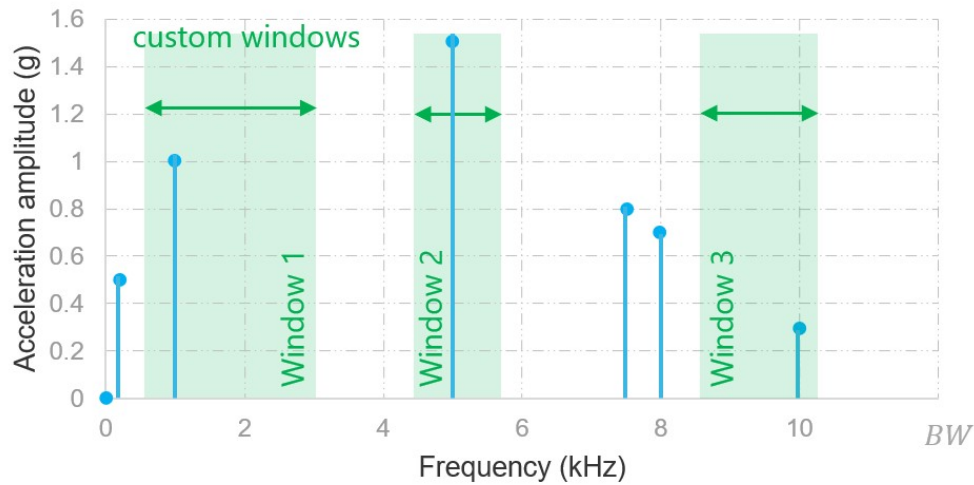

Typical FFT spectrum showing eight peaks and 3 windows

3.5. COMMUNICATION – LoRaWAN™

The device includes a LoRaWAN™ MAC 1.0.3 rev A compliant interface (see LoRaWAN® 1.0.3 Specification). It operates as a Class A end-device. The LoRaWAN™ communication protocol operates in an unlicensed radio spectrum. The part number must be selected to match with the region of operation and be in line with the local regulation.

Region	Frequency	Channel Plan	Common name
Europe (EU)	868 MHz	EU862-870	EU868
United State (US)	915 MHz	US902-928	US915

The LoRaWAN™ upload interval can be configured by the customer for any time between one minute and 24 hours (in one-minute steps).

Data upload consists of this information:

- Battery status
- Sensor internal temperature
- All FFT data as configured by the user
- Raw sensor data (time domain accelerometer signal) is not available for upload

All customer configurable parameters can be adjusted via LoRaWAN™ using a data download:

- Reading/upload interval
- Number of peaks
- Number of bins around the peaks
- Number of windows
- Window minimum frequency
- Window maximum frequency

Many of the LoRaWAN™ communication features are adaptive and depend on the network quality. The parameters are negotiated and optimized with the connected gateway.

LoRaWAN™ communications are subject to various regulatory bodies around the world and features in the device firmware help maintain compliance.

3.6. BLUETOOTH® LOW ENERGY

The device includes a Bluetooth 5.0 Low Energy compliant interface. This is a low power communication technology which should be used at short distances. It makes the 89X1N a connectable beacon which acts as a peripheral by default and switches to a server role (pairing mode) once a remote device (central) is connected. The BLE interface should be used for device configuration only. BLE is activated automatically upon battery insertion. After one hour, the BLE is de-activated to conserve battery energy. BLE can be re-activated by using the magnet switch. After one hour, BLE is de-activated again.

4. Magnetic Switch

The 89X1N has an internal reed switch. This switch is activated when a strong magnet is close to the magnetic sensor location. The magnetic switch location is indicated by the magnet icon on the plastic housing. The magnet must be of sufficient strength and proximity to create a magnetic field of 25 mT at the switch location.



Two different functions are available depending on the user action:

User action	Function	LED
Short tap	Activates BLE for another one hour plus trigs a new measurement and a LoRaWAN™ transmission (uplink if joined, else join request).	One short blink. If user holds the magnet close to the switch for a longer duration, the LED will blink faster. Remove the magnet to only initiate a transmission. Else it going to initiate a sensor reset.
Hold magnet for 10+ seconds	Resets the sensor.	Wait for at least 10 seconds, to see the very fast blink. Release the magnet once a very long orange led appears

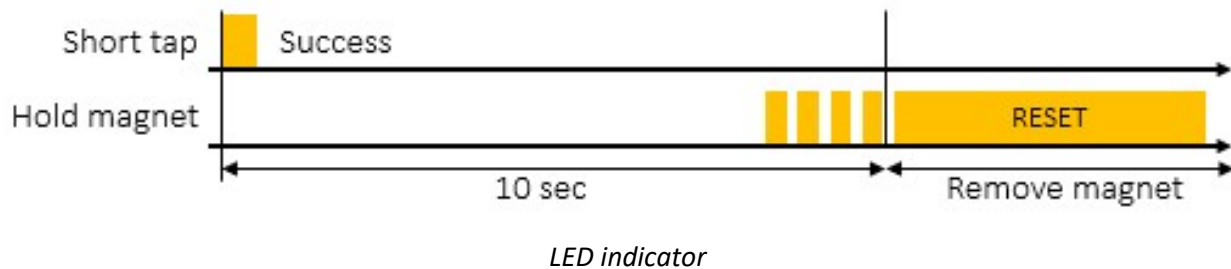

5. LED Indicator

The orange LED indicates the state of the 89X1N.

Category	Mode	Description	Pattern
	Power-on/Reset	Led turned on at start up to confirm the battery insertion.	A 2 sec long on
	LoRaWAN™join request	Join request message sent	3 very short blinks
	Uplink	Sending uplink message	very short blink
Status	Success	Operation successful	very short blink
	Fail	Operation failed	1sec long on

The time plots below show the different flash sequences that occur for various actions the sensor is taking.

5.1. LoRaWAN™ Join request examples

A normal join request gives 3 fast blinks (few milliseconds on), a 6 second delay then another short blink. In case of error, the LED is turned on for about 1 second.

Scenario #4: A LoRaWAN™ join request is shown with 3 short blinks (few milliseconds on) and about a 6 second later, another short blink (join accept from the gateway).

Scenario #5: For EU-868 region, if an error pattern (1 sec on) is shown just after the 3 blinks, it means the device hasn't sent the message due to duty cycle restrictions.

Scenario #6: In case no response from the gateway, and after about 6 sec after the 3 short blinks, the LED is turned on for about 1 second.

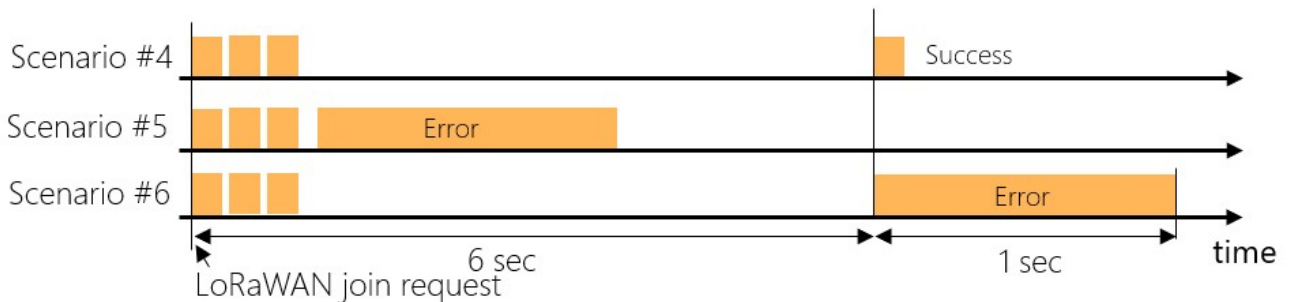

5.2. LoRaWAN™ Uplink transmission Examples

Scenario #1: A normal uplink transmission gives 1 short blink (few milliseconds on) and few seconds later, another short blink (ack from the gateway).

Scenario #2: For EU-868 region, if an error pattern (1 sec on) is shown just after a short blink, it means the device hasn't sent the message due to duty cycle restrictions.

Scenario #3: In case no response from the gateway (Confirmed message up needs a downlink with an acknowledge), delay is about 2 sec after the short blink, the LED is turned on for about 1 second (nack).

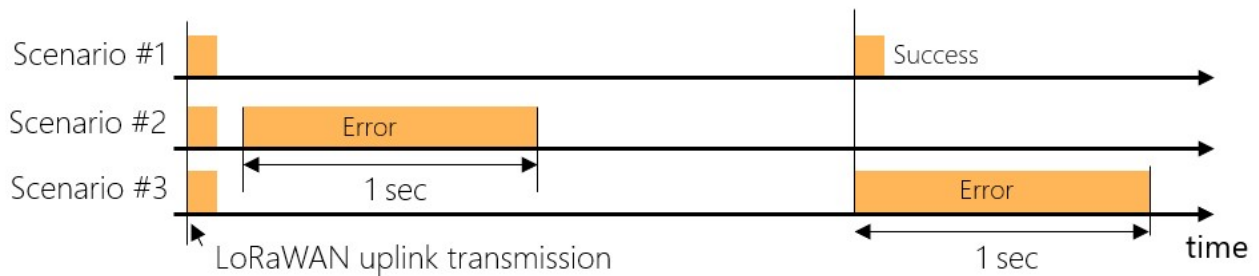

6. Presets

The 89X1N has several adjustable functions that tailor the output data to meet user needs. To easily manage these functions, the 89X1N has a feature called “Preset”. This feature allows the user to combine functions into commonly used or unique preset configurations.

The presets are divided in three different categories:

- **User:** editable area which allows the user to create his own configurations.
- **Factory predefined:** read only preset which are callable for an easy and fast configuration
- **Factory customer predefined:** same as above, read-only and hidden area reserved for identified customers including their own private settings

By default, the 89X1N uses the “User preset 0”. Any change to the sensor settings such as Bandwidth, Measurement interval, Windows count... will affect the “user preset 0” only. The table below shows the various preset configurations. There are 16 user adjustable configurations (ID 0 – 15) and 15 factory predefined configurations (ID 64 – 78).

Category	Preset Name	ID	BW (Fs/2.56)	Meas interval	Windows Count	Windows			
						FreqMin	FreqMax	Integ bin	Peaks
 User	User preset 0	0	14.4k	1 hour	0	bandwidth		20	8
	User preset 1	1	14.4k	1 hour	0	bandwidth		20	8

	User preset 15	15	14.4k	1 hour	0	bandwidth		20	8
 Factory Predefined	89X1_Legacy	64	14.4k	1 hour	0	bandwidth		20	8
	BW1K6_ULP	65	1.6k	1 day	1	0	1.6k	4	8
	BW4K8_ULP	66	4.8k	1 day	1	0	4.8k	4	8
	BW9K6_ULP	67	9.6k	1 day	1	0	9.6k	4	8
	BW1K6_LP	68	1.6k	0.5 day	1	0	1.6k	4	8
	BW4K8_LP	69	4.8k	0.5 day	1	0	4.8k	4	8
	BW9K6_LP	70	9.6k	0.5 day	1	0	9.6k	4	8
	BW1K6_STD	71	1.6k	1 hour	1	0	1.6k	4	8
	BW4K8_STD	72	4.8k	1 hour	1	0	4.8k	4	8
	BW9K6_STD	73	9.6k	1 hour	1	0	9.6k	4	8
	BW1K6_HR	74	1.6k	10 min	1	0	1.6k	4	8
	BW4K8_HR	75	4.8k	10 min	1	0	4.8k	4	8
	BW9K6_HR	76	9.6k	10 min	1	0	9.6k	4	8
	BW9K6_RTH	77	9.6k	5 min	1	1.6k	9.6k	4	8
	BW1K6_RTL	78	1.6k	55 min	1	0	1.6k	4	8

6.1. MANAGING PRESETS

By default, the sensor uses the “User Preset 0”. It is possible to switch between 2 presets by writing the preset identifier to be loaded in a specific register. It can be done anytime.

Once the preset loaded, the parameters shown in the previous table are applied and are instantaneously effective.

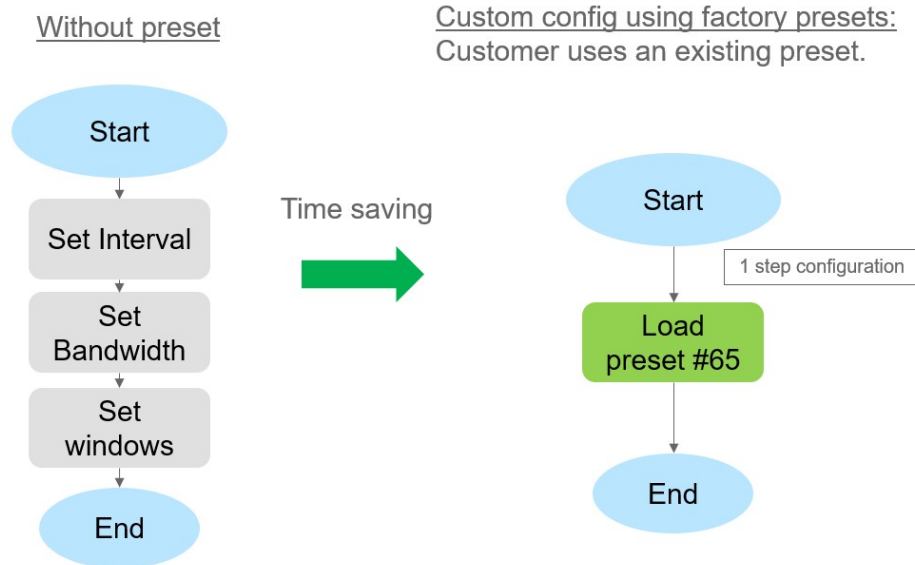

If the selected preset is a user preset, the parameters of the active preset can be modified (and saved) in the usual way (over BLE or LoRaWAN™) using the default commands.

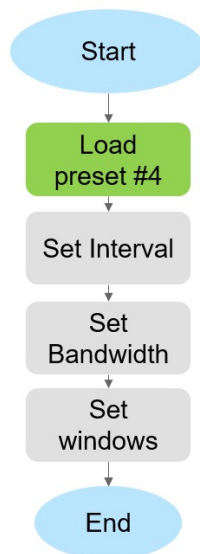

6.2. ROTATING PRESET MODE

In addition to the presets, the 89X1N implements a feature called “Rotating mode”. This provides the user a way to alternate between two presets continuously. After the execution of a preset, the second preset queued in the mode will be loaded, then once executed it comes back to the first.

The example below shows how to take advantage of the rotating mode. Here 2 presets are configured with 2 different bandwidth and measurement interval.

The self-Rotating mode automatically switches between #0 and #1 without any external user action required.

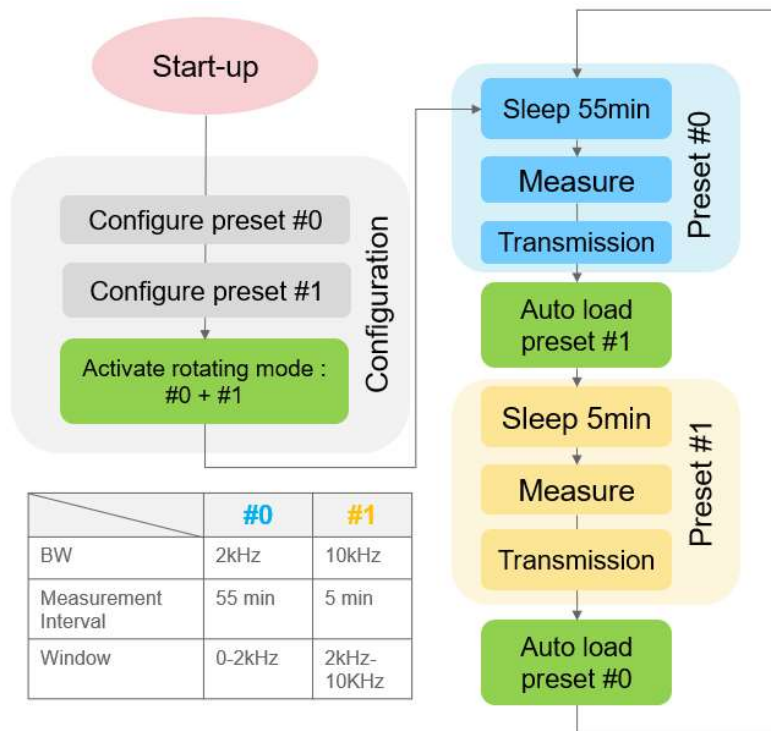

With the example, every 1 hour will result of having 2 measurements: one with a high frequency band and another (5min later) with a low bandwidth but with a higher resolution.

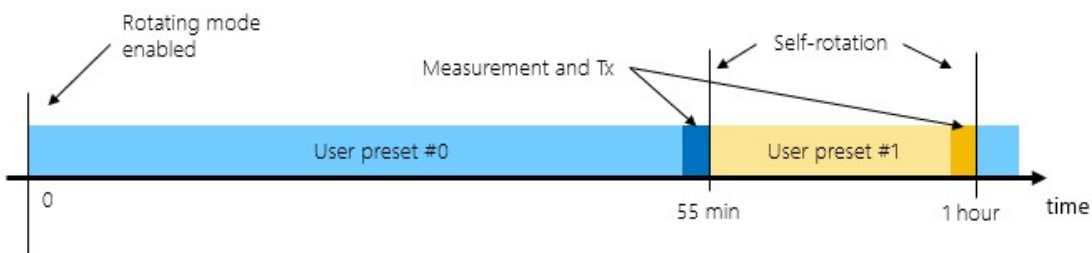

7. Battery

7.1. BATTERY TYPE

To meet various certification requirements, the following battery must be used:

Parameters	Typical value
Manufacturer	SAFT
Reference	LS 17330
Technology	Primary lithium-thionyl chloride (Li-SOCl ₂)
Nominal voltage	3.6 V
Capacity at 20°C	2100 mA
Operating temperature range	- 60°C/+ 85°C

7.2. BATTERY LIFE

Depending on customer settings (measurement interval) and on LoRaWAN™ network quality, the 89X1N battery life could go up to 10 years. The number of measurements per day will affect the battery life. More measurements will reduce the battery life.

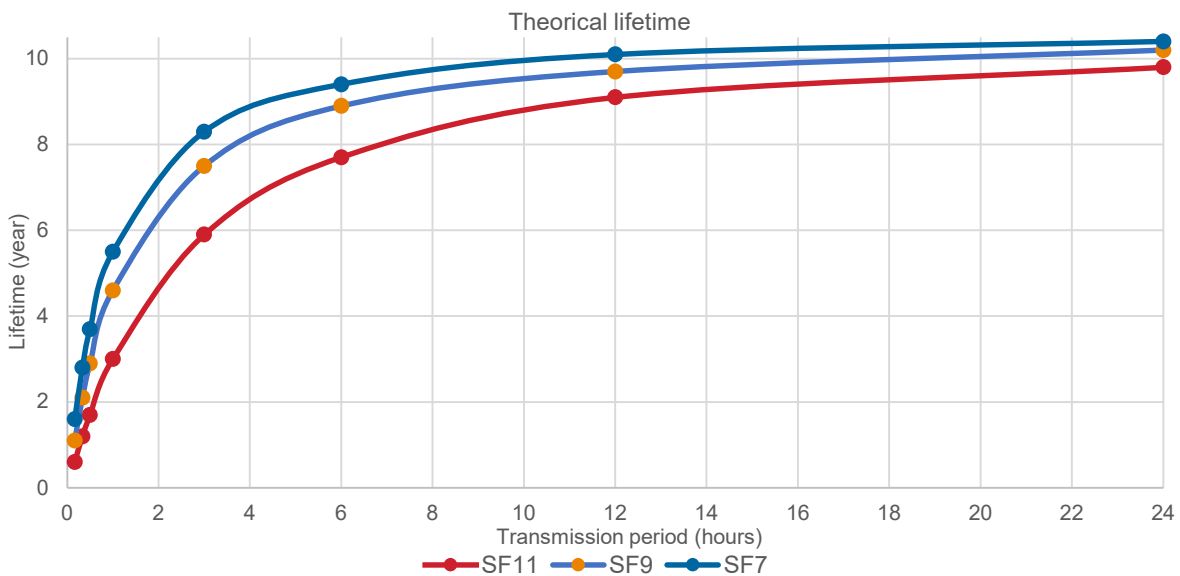

7.3. BATTERY REPLACEMENT

The 89X1N's battery must be replaced if depleted. Unscrew the plastic housing and remove it from the base. Carefully use a small tool (such as a flat screwdriver) to remove the battery. Note that it **MUST** be replaced by the same battery type as shown above. Substitute batteries may damage and/or bring uncontrolled behavior to the sensor. Double check the polarity and then insert the new battery inside the holder. Re-attach the plastic cover on the sensor. Refer to the Installation Manual (Doc# 20023687-24) for specific details regarding battery installation and replacement.

When complete, the battery life estimator in the firmware must be reset to a “full” battery status.

7.4. BATTERY ESTIMATION ALGORITHM

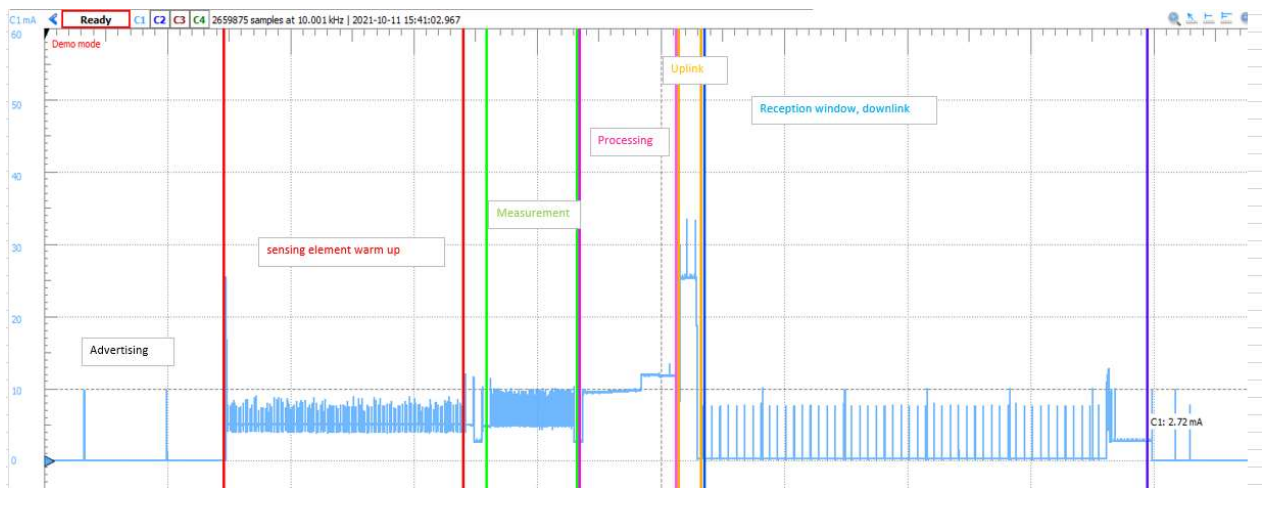

Simplified current profile (1 measurement)

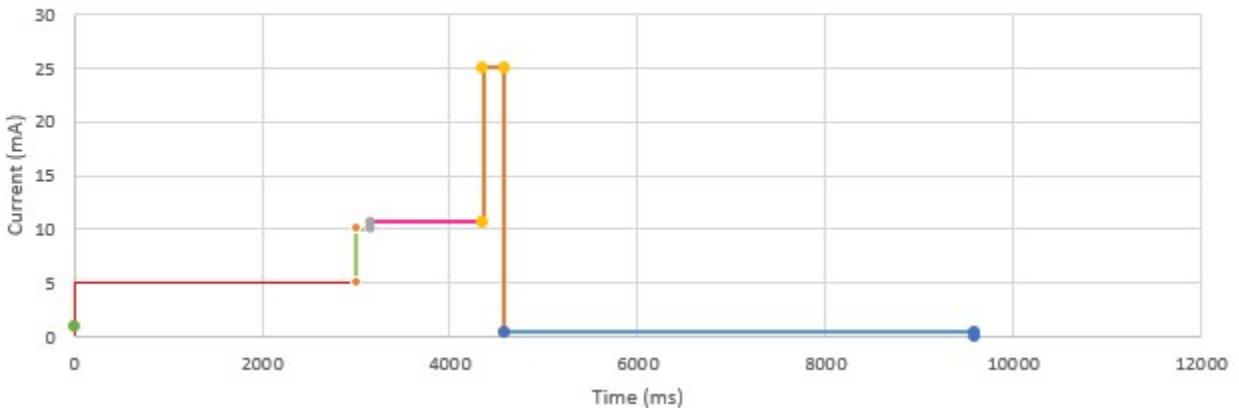

7.4.1. CURRENT CONSUMPTION PROFILES

Current consumption (mA) profiles over temperature (°C)

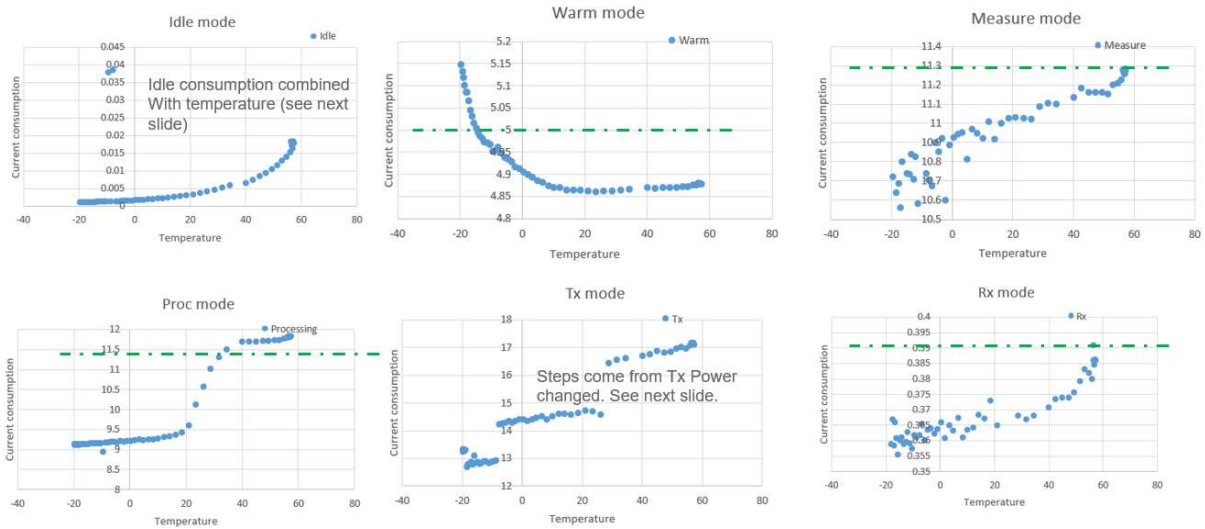

Current consumption profiles over temperature

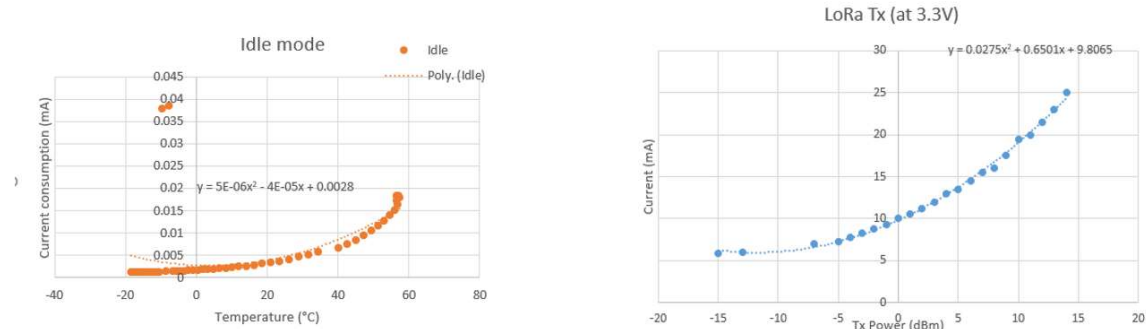

Cell voltage guards

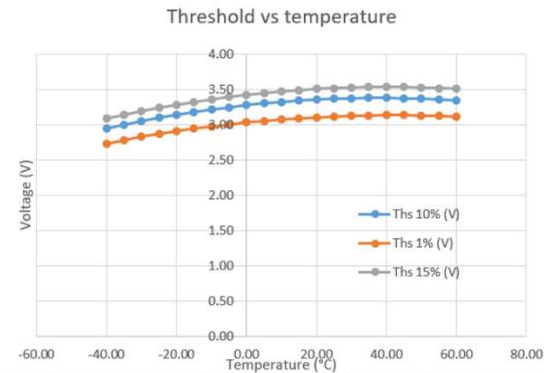

8. Dimensions

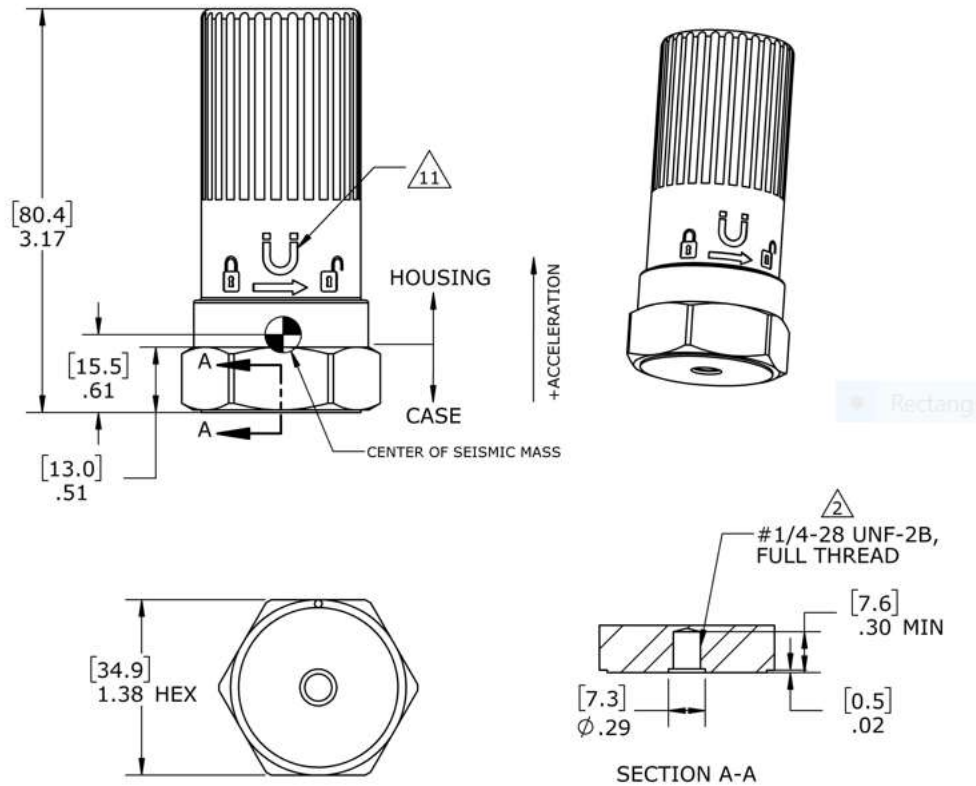

9. Mounting Considerations & Accessories

A solid mounting method is required to get optimum performance from the accelerometer. Any loose parts or unsecured mounting features will introduce noise and corrupt the signals of interest. Shown below are six different mounting options available for the 89X1N accelerometer.

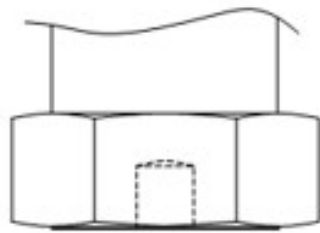

1/4-28 UNF Female THD
(Integrated part of the sensor)

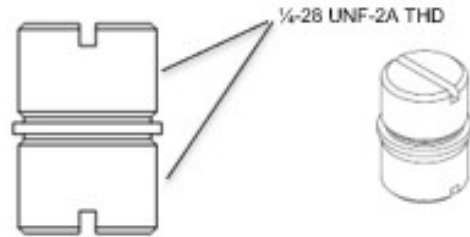

1/4-28:1/4-28 Male Stud
P/N AC-D03636

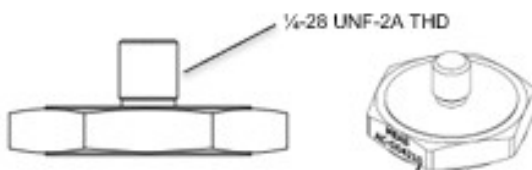

Adhesive Mounting Stud
P/N AC-D04210

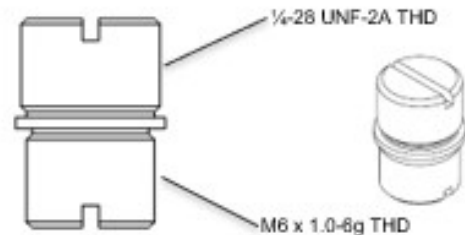

1/4-28:M6 Male Stud
P/N AC-D03665

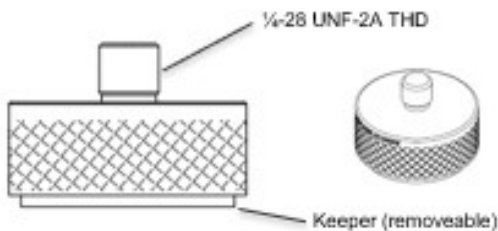

Magnetic Mounting Stud
P/N AC-A04209

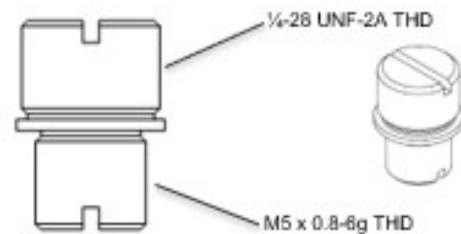

1/4-28:M5 Male Stud
P/N AC-D03664

For the adhesive mounting stud, secure with a rigid adhesive such as epoxy or cyanoacrylate. Do not use pressure sensitive adhesives or foam tapes. For the magnetic mounting stud, remove the keeper prior to attachment. The magnetic mounting will have a 30 lb pull strength when attached to a ferrous surface.

Note – Some mounting accessories may be supplied with sample orders. For production deliveries, desired mounting accessories must be ordered as a separate item.

10. Certifications & Compliances

CERTIFICATIONS

8911N and 8931N Wireless Sensors with characteristic (EX) in model name are certified for Intrinsic Safety to the following classification:

IS Class I, Div1, Groups A, B, C, and D;
Class I Zone 0, AEx ia IIC T4 Ga;
Ex ia IIC T4 Ga;
II 1 G Ex ia IIC T4 Ga

Please see section 12 for details on how to order.

11. REGULATORY STATEMENTS

FCC and IC

This Radio Equipment is Certified for FCC (US) and ISED (Canada).

This equipment does not support simultaneous transmissions.

Changes or modifications not expressly approved or authorized by TE Connectivity for compliance could void the user's authority to operate the equipment.

FCC Warning:

THIS DEVICE COMPLIES WITH PART 15 OF THE FCC RULES. OPERATION IS SUBJECT TO THE FOLLOWING TWO CONDITIONS: (1) THIS DEVICE MAY NOT CAUSE HARMFUL INTERFERENCE, AND (2) THIS DEVICE MUST ACCEPT ANY INTERFERENCE RECEIVED, INCLUDING INTERFERENCE THAT MAY CAUSE UNDESIRE OPERATION.

Note: This equipment has been tested and found to comply with the limits for a Class B digital device, pursuant to Part 15 of the FCC Rules. These limits are designed to provide reasonable protection against harmful interference in a residential installation. This equipment generates, uses, and can radiate radio frequency energy and, if not installed and used in accordance with the instructions, may cause harmful interference to radio communications. However, there is no guarantee that interference will not occur in a particular installation. If this equipment does not cause harmful interference to radio or television reception, which can be determined by turning the equipment off and on, the user is encouraged to correct the interference by one or more of the following measures:

- Re-orient or relocate the receiving antenna
- Increase the separation between the equipment and the receiver
- Connect the equipment to an outlet on a circuit that is different from that to which the receiver is connected.
- Consult the dealer or an experienced radio/TV technician for help.

Industry Canada (IC) Warning:

This device complies with ISED Canada licence-exempt RSS standard(s). Operation is subject to the following two conditions: (1) this device may not cause interference, and (2) this device must accept any interference, including interference that may cause undesired operation of the device.

Le présent appareil est conforme aux CNR d'ISED Canada applicables aux appareils radio exempts de licence. L'exploitation est autorisée aux deux conditions suivantes : (1) l'appareil ne doit pas produire de brouillage, et (2) l'appareil doit accepter tout brouillage radioélectrique subi, même si le brouillage est susceptible d'en compromettre le fonctionnement.

IMPORTANT NOTE:

Radiation Exposure Statement:

This equipment should be installed and operated with minimum distance 20cm between the radiator & your body.

Déclaration d'exposition aux radiations:

Cet équipement est conforme Canada limites d'exposition aux radiations dans un environnement non contrôlé. Cet équipement doit être installé et utilisé à distance minimum de 20cm entre le radiateur et votre corps.

EU Conformity

The products below were tested by approved agencies and found compliant with EU regulatory standards.

Model Families: 8911N & 8931N

Product Description: Wireless Vibration Sensor

Manufacture/Brand: TE Connectivity Ltd

Manufacturer:

Measurement Specialties (China) LTD
No 26 LangShan Road
518057 Shenzhen-Nanshan District, China

European Contact:

TE Connectivity Sensors France
4 Rue Gaye Marie
31027 Toulouse – France

12. Ordering Information

Model Number:

8 9 **1 N** - -

Sensor Axis	
1	Uniaxial
3	Triaxial

Certification	
NX	None
EX	Explosive Atmospheres: ATEX/IECEX/US/CANADA IS CL I, DIV 1, GRP A, B, C, D, T4; CL 1. ZN 0, AEx ia IICT4 Ga; II 1 G, Exia IIC T4 Ga;

Tx/Rx Frequency	
A	915 MHz (USA)
E	868 MHz (EMEA)

Mounting Accessories	
Part Number	Description
AC-D04210	Adhesive Mounting Stud
AC-A04209	Magnetic Mounting Stud
AC-D03636	¼ x 28 by ¼ x 28 Double-ended Male Stud
AC-D03665	¼ x 28 by M6 Double-ended Male Stud
AD-D03664	¼ x 28 by M5 Double-ended Male Stud

Sales and technical support

NORTH AMERICA

Measurement Specialties, Inc.,
a TE Connectivity Company
Phone: +1 800-745-8008
Email: TEsensors-CCMeas@te.com

EUROPE

Measurement Specialties (Europe), Ltd.,
a TE Connectivity Company
Phone: +31 73 624 6999
Email: customer-care.lcsb@te.com

ASIA

Measurement Specialties (China), Ltd.,
a TE Connectivity Company
Phone: +86 0400-820-6015
Email: customer-care.shzn@te.com

Manufacturer: Measurement Specialties (China) Inc., a TE Connectivity Company
No. 26 Langshan Road, Shenzhen High-Tech Park (North), Nanshan District, Shenzhen, 518057
Tel: +86 0400-820-6015 customer-care.shzn@te.com