

Figure 1

1. INTRODUCTION

This instruction sheet covers the assembly procedures for the Screw-On Series Straight Solder Plugs and Jacks with Two Insulators. See Figure 1.

NOTE
 Dimensions on this sheet are in inches [with millimeters in brackets]. Figures and illustrations are for identification only and are not drawn to scale.

Step 1

Slide bend relief cap, nut, and ferrule over cable jacket. See Figure 2.

NOTE
 If assembly is supplied with a pin protector, slide it over cable jacket after the bend relief cap.

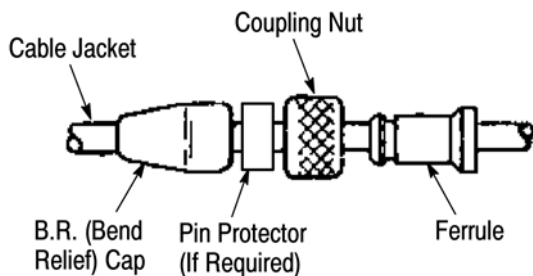

Figure 2

Step 2

Strip cable to dimension shown in Figure 3.

CAUTION
 Be careful not to nick shield.

Note: For assembly to cables with "Mini-Noise" coating, Mini-Noise coating must be removed from surface of cable dielectric as follows:

1. Painted Coatings: Wipe off dielectric surface with a dry cloth. Wipe again using paint thinner or trichloroethane. Do not immerse cable in solvent.

2. Tape or Fused Coatings: Remove with sandpaper, file, or scraping action of razor blade. Do not damage dielectric.

DANGER
 To prevent personal injury, use caution when handling file or razor blade.

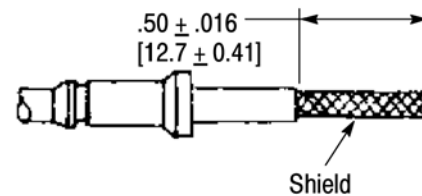

Figure 3

Step 3

Place jerk ring, slotted end first, over the shield. The slotted end butts against the end of the jacket. See Figure 4.

Squeeze the ring snugly around the shield. Squeeze the slotted end of the ring to a slight taper. Use TE Connectivity Tool 4-1532129-2 (Microdot* Tool 010-0009-0000) or suitable pliers.

NOTE
 Care should be taken to keep the jerk ring round.

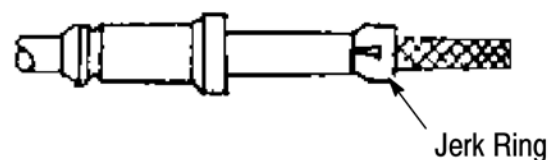

Figure 4

Step 4

Unbraid shield wires and cut close to ferrule ring. See Figure 5.

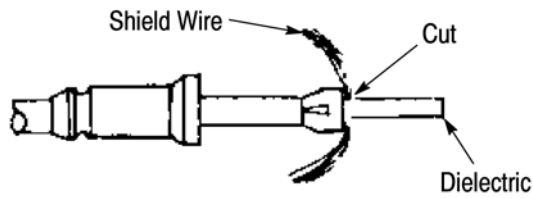

Figure 5

Step 5

Strip dielectric to dimensions shown in Figure 6. If inner conductor is stranded, it must be tinned.



Be careful not to nick inner conductor.

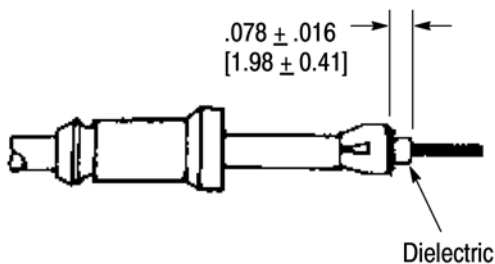

Figure 6

Step 6

Slip insulator "A" over inner conductor and dielectric until insulator is against shield wires.

Cut inner conductor close to end of insulator "A" as shown in Figure 7.

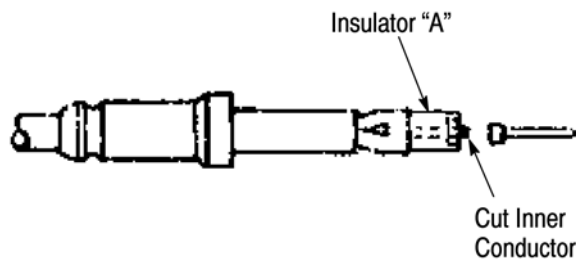

Figure 7

Step 7

Push head of pin over the inner conductor and inside of insulator "A". Contact must be firmly in place.

Apply solder as shown in Figure 8.

Use 1/32 in. maximum diameter resin core solder only.

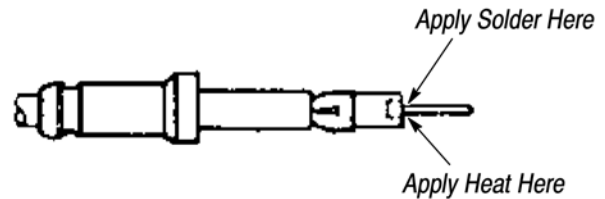

Figure 8

Step 8

Slip insulator "B" over pin and insulator "A" until insulator "A" is completely nested in insulator "B". See Figure 9.

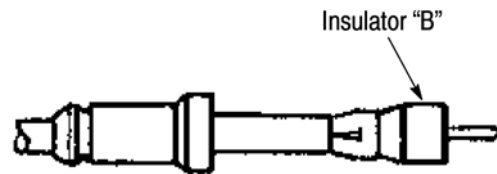

Figure 9

Step 9

Hold ferrule in one hand. With the other hand, push insulator "B" until it is half way in the ferrule. See Figure 10.

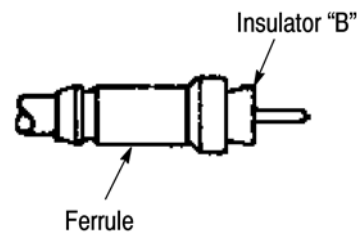
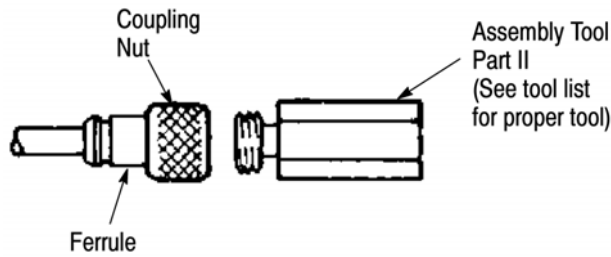

Figure 10

Step 10

Slide coupling nut over ferrule.

Screw coupling nut to Part II on tool until fully seated. See Figure 11.



ASSEMBLY TOOLS

TE PART NO.	MICRODOT* PART NO.	OHM/THD
4-1532129-0	010-0003-0000	50 Ohm (.190-32 THD)
3-1532136-2	010-0004-0000	70 Ohm (.216-32 THD)
4-1532129-1	010-0005-0000	93 Ohm (.250-32 THD)

CAUTION: Tools listed are most common. See individual drawings for exceptions.

Figure 11

Step 11

Screw Part I of tool into Part II thus forcing insulator completely into ferrule.

Remove Part I and Part II. See Figure 12.

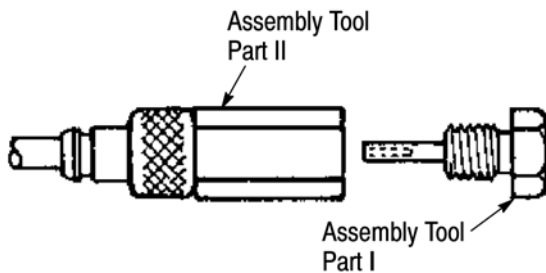

Figure 12

Step 12

Position pin protector, if provided, behind coupling nut.

Bring the bend relief cap up and snap it over groove in ferrule body. See Figure 13.

This completes assembly.

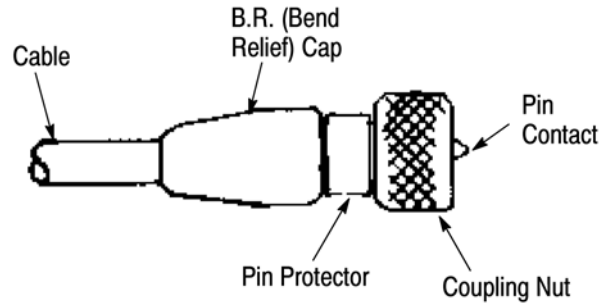

Figure 13

NOTE

The assembly instructions on this instruction sheet are for plugs. Jacks assemble similarly, with the following exceptions:

- Socket contact replaces pin contact and assembles in the same way;
- After assembly Step 9, assemble tool Part III to ferrule before proceeding with Step 10. See Figure 14;
- After disassembling tool (Step 11), install gasket behind threads on ferrule. See Figure 14.

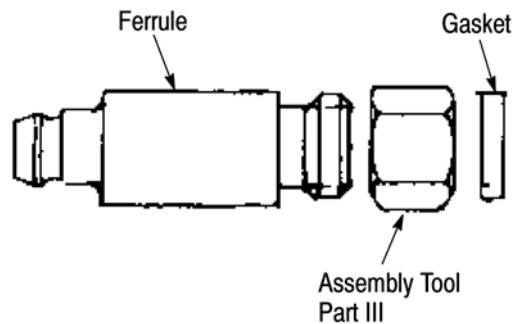

Figure 14

2. REVISION SUMMARY

- New logo