

Figure 1

1. INTRODUCTION

This instruction sheet covers the installation and setup procedures for Connector-Specific Kit 679167-1. The connector-specific kit is used with Base Assembly Universal Arbor Tool 768338-2 (408-9875) and Manual Arbor Frame Assembly 91085-2 (408-7777) (shown in Figure 1) or Pneumatic Auto-Cycle Unit 91112-3 (408-6732) to terminate AMP-LATCH System 50 receptacle connectors onto cable.

Refer to instruction sheets (given in parenthesis) supplied with the tool for tooling information. For information on AMP-LATCH connectors, contact PRODUCT INFORMATION at the number at the bottom of this page.

Reasons for reissue of this instruction sheet are provided in Section 6, REVISION SUMMARY.

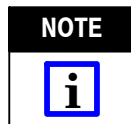

NOTE Dimensions in this instruction sheet are in millimeters [followed by inches in brackets].

2. DESCRIPTION (Figure 1)

The connector-specific kit consists of an upper tool, a lower insert, two locators, and a cable stop. The upper tool is secured to the upper tool mount and applies an even force over the length of the connector during termination. The locators and the lower insert properly align the connector for termination.

3. CABLE REQUIREMENT

The receptacle connectors accept 0.64 [.025] centerline ribbon cable with solid or stranded conductors size 30 AWG or stranded conductors size 32 AWG (7 strands/40 AWG). Refer to Figure 2 for recommended cable dimensions.

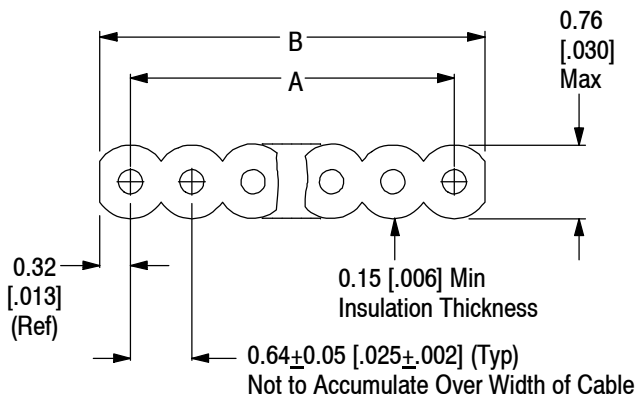

NUMBER OF CONDUCTORS "N"	DIMENSION	
	A	B
10-60	$[(N-1) \times 0.64] \pm 0.18 \text{ mm}$ $[(N-1) \times .025] \pm .007 \text{ in.}$	$(N \times 0.64) \pm 0.13 \text{ mm}$ $(N \times .025) \pm .005 \text{ in.}$
61-72	$[(N-1) \times 0.64] \pm 0.20 \text{ mm}$ $[(N-1) \times .025] \pm .008 \text{ in.}$	
73-100	$[(N-1) \times 0.64] \pm 0.23 \text{ mm}$ $[(N-1) \times .025] \pm .009 \text{ in.}$	

Figure 2



The cable must be cut 90° (refer to Application Specification 114-25029 for tolerance) to the edge of the cable; otherwise, an improper termination will result. It is suggested that a guillotine-type cable cutter be used, such as Carpenter Model 95, which can be purchased from: Carpenter Manufacturing Co., Inc. Fairgrounds Drive Manlius, NY 13207

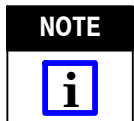

Cable assemblies manufactured by TE contain ribbon cable meeting the requirements of Drawing 57013 (solid conductors) or Drawing 57131 (stranded conductors). The receptacle connectors are available in various sizes from 20 to 100 positions. If you choose to assemble your own cable assemblies using these connectors, it is recommended using a cable of equal or superior quality.

4. INSTALLATION AND SETUP

4.1. Installation

These procedures are typical for the manual arbor frame assembly and the pneumatic auto-cycle unit. Before installing the connector-specific kit, install the base assembly universal arbor tool onto the frame assembly as described in 408-9875.



When using the pneumatic auto-cycle unit, DISCONNECT the air from the main air valve.

1. Slide the upper tool onto the upper tool mount as shown in Figure 3.
2. Slide the lower insert into the slot of the lower tooling assembly and secure it with the two setscrews. See Figure 3.
3. Install the locators onto the lower insert as shown in Figure 3. Secure the locators with the socket head cap screws just enough to hold them in place.
4. Install the cable stop (supplied with the connector-specific kit) onto the lower tooling assembly as shown in Figure 3. Secure the cable stop with the thumbscrew after it is properly positioned.

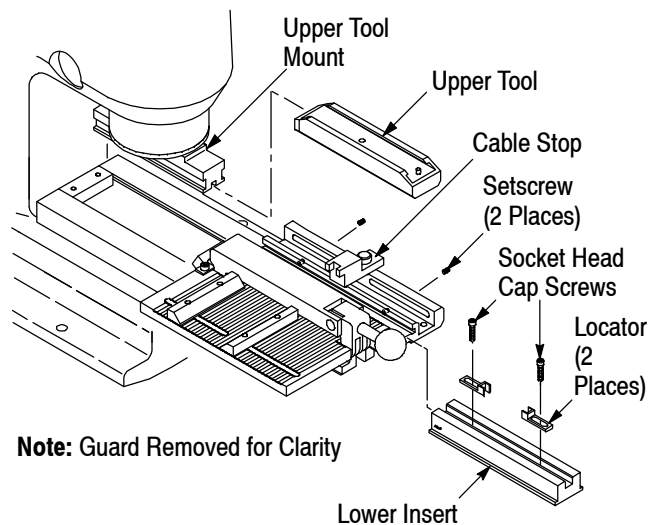
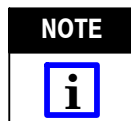

Figure 3

4.2. Setup

1. Open the cable clamp assembly.
2. Slide the cable through the connector; then insert the connector (cover up) into the lower insert and between the locators. See Figure 4.
3. Position the cable so that the cable end is positioned against the cable stop and the cable conductors are positioned in the flutes of the fluted plate.



The cable conductors must stay in the same flutes for the entire length of the fluted plate.

4. Slide locators against the connector; then secure the locators with the socket head cap screws. The connector must fit securely between the locators, as shown in Figure 4.

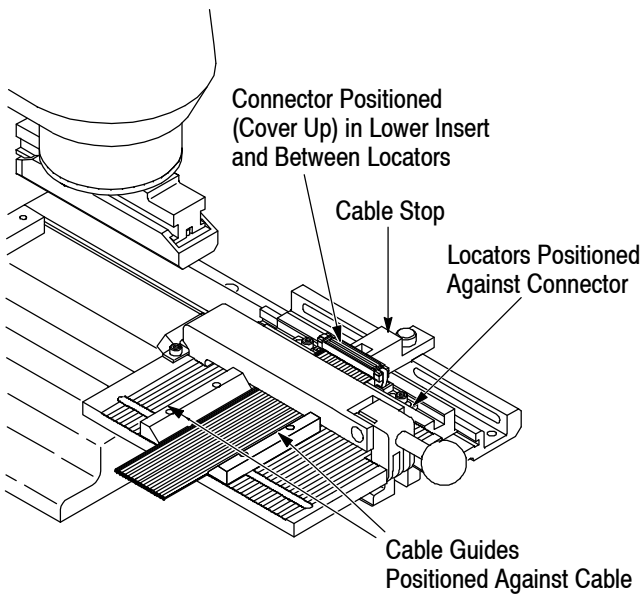

Note: Guard Removed for Clarity

Figure 4

5. Slide the cable guide (located on the side of the cable with the registration mark) against the cable and secure it with the thumbscrew. Slide the other cable guide against the cable and secure it with the thumbscrew. See Figure 4.

6. Slide the cable guide (located on the side of the cable with the registration mark) against the cable and secure it with the thumbscrew. Slide the other cable guide against the cable and secure it with the thumbscrew. See Figure 4.



Before terminating any connectors, re-install the front guard on the frame assembly. When using the pneumatic auto-cycle unit, reconnect the air supply to the main air valve.

7. Perform a test termination and inspect the connector to ensure that the cable conductors are properly aligned with the contacts. If available, use a tester to inspect the termination or remove the connector cover and inspect the termination with a microscope. Refer to 408-9875 for termination procedure and 114-25029 for termination height dimension.

5. REPLACEMENT AND REPAIR

Figure 5 lists customer-replaceable parts for the connector-specific kit. To purchase kits or replacement parts, contact your local Representative, or call 1-800-526-5142, or send a facsimile of your order to 1-717-986-7605, or write to:

CUSTOMER SERVICE (38-35)
 TYCO ELECTRONICS CORPORATION
 PO BOX 3608
 HARRISBURG, PA 17105-3608

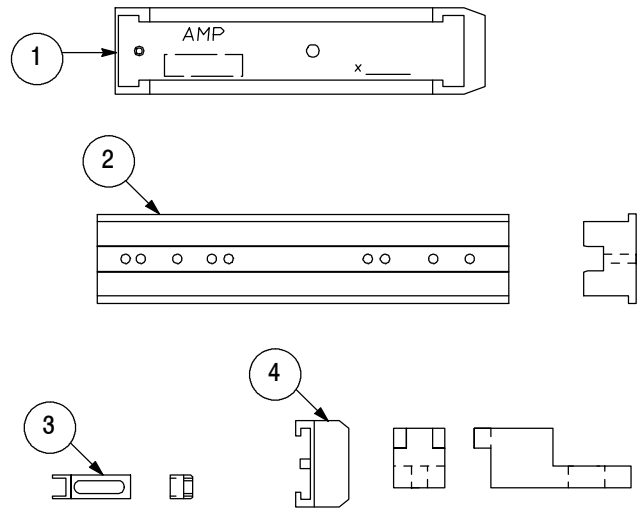

ITEM	PART NUMBER	DESCRIPTION	QTY PER KIT
1	679100-2	UPPER TOOL	1
2	679074-1	INSERT, Lower	1
3	679075-1	LOCATOR	2
4	679069-3	STOP, Cable	1
—	1-21000-4	SCREW, Socket Head Cap, 4-40 x .380-in. Long	2

Figure 5

6. REVISION SUMMARY

Revisions to this instruction sheet include:

- Updated document to corporate requirements.