



## Product Installation Procedure (PIP)

No:	<b>TEC-114-120001</b> PIP-047	Revision:	<b>A</b>	Dated:	January 2018
-----	----------------------------------	-----------	----------	--------	--------------

**Title:-**                      **Selection, Cutting and  
Installation of HFT5000**

Prepared By:	Name: Clive Benning	Date: January 2018
Reviewed & Approved By:	Name: Richard Kewell	Date: January 2018

**Note:** This document is electronically reviewed and approved - therefore no signature will appear

No:	TEC-114-120001	Revision:	A	Dated:	January 2018
-----	----------------	-----------	---	--------	--------------

# Contents

	<u>Page</u>
1        Scope .....	3
2        Revision History/ Reason for Change/ Related Documents .....	4
3        Introduction .....	4
4        Selection of Product Size .....	4
5        Selection of Product Cut Length .....	8
6        Cutting HFT5000	10
7        Positioning Product on the Substrate .....	13
8        Shrinking HFT5000 .....	14

No:	TEC-114-120001	Revision:	A	Dated:	January 2018
-----	----------------	-----------	---	--------	--------------

# 1 Scope

This document is intended to give guidelines of how to:

- ♦ Select a suitable HFT5000 product size
- ♦ Select a suitable product cut length
- ♦ Cut the HFT5000 product to the correct length
- ♦ Position the HFT5000 product on the substrate
- ♦ Shrink the HFT5000 product on the substrate

**Fig.1: The Installation Process Flow Chart**

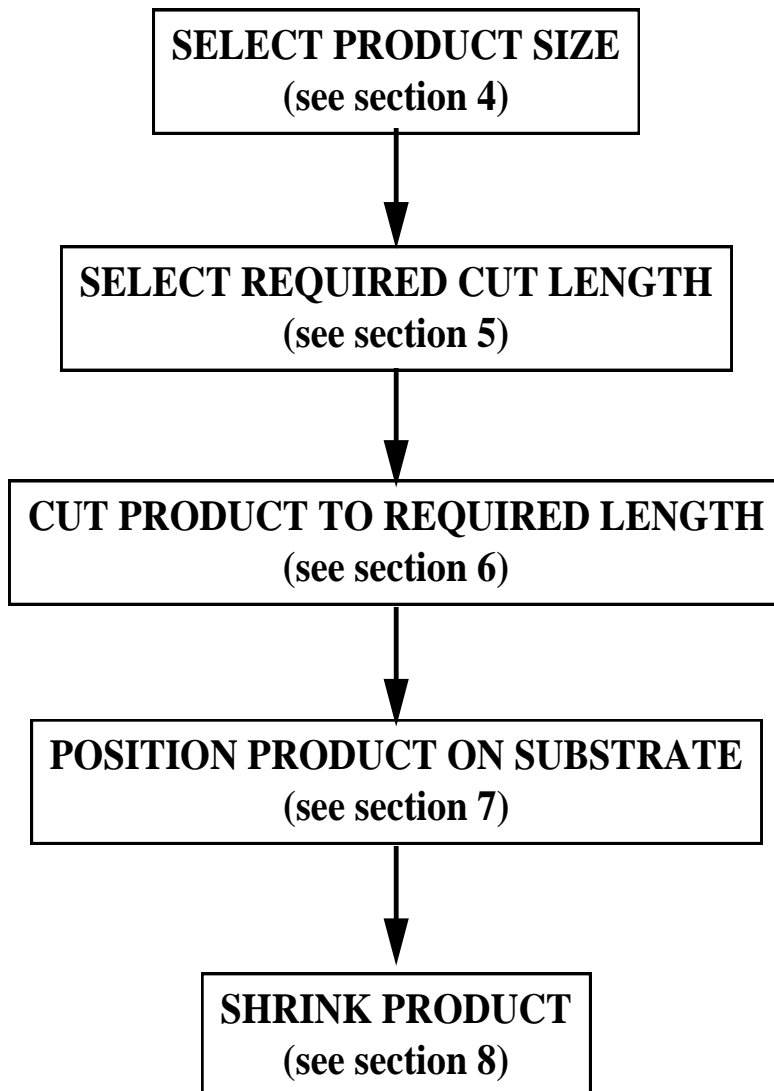

The document will give general guidance only. The ‘best’ solution for any particular substrate may vary depending on the substrate complexity, bulk and installation process utilized by the installer. It is, therefore, recommended that trial installations are carried out to determine the most suitable solution for any particular substrate or process.

No:	<b>TEC-114-120001</b>	Revision:	<b>A</b>	Dated:	January 2018
-----	-----------------------	-----------	----------	--------	--------------

## 2 Revision History / Reason for Change

Rev No	Date	Requested By	Incorporated By
		Previously PIP-047 Rev1	
A	January 2018	QC Trutnov	Clive Benning

*Reason for change:*                      *Addition of Hot air gun installation process.*

*Related Documents:*                      *RAY3145-EC                      Health & Safety Data Sheet*

## 3 Introduction

HFT5000 heat-shrinkable fabric tubing has been developed for use in applications where protection of a substrate, for example, a rubber substrate or wire harness, from wear due to abrasion is required.

This product installation guideline is intended to give guidance of how to install product onto such substrates.

Please refer to Raychem Safety Data Sheet RAY3145-EC for Health and Safety information.

## 4 Selection of Product Size

HFT5000 is a 2:1 shrink ratio product that should be selected for any substrate with a uniform diameter such that the product can be easily installed.

Figure 3 (page 6) indicates the maximum and minimum substrate diameters for each HFT product.

When selecting the size of HFT to use, ensure that the substrate outer diameter falls within the recommended maximum and minimum dimensions indicated by the solid bar portion for each HFT size shown in figures 3a and 3b. HFT5000 will provide good performance over a wide range of installed recovery ratios.

The final size of HFT selected and used can depend on two other aspects (as shown in figure 2):

1.            Ease of positioning of the fabric onto the substrate
2.            Visual appearance of product on complex substrate shapes.

No:	TEC-114-120001	Revision:	A	Dated:	January 2018
-----	----------------	-----------	---	--------	--------------

Fig 2

A) Large product size

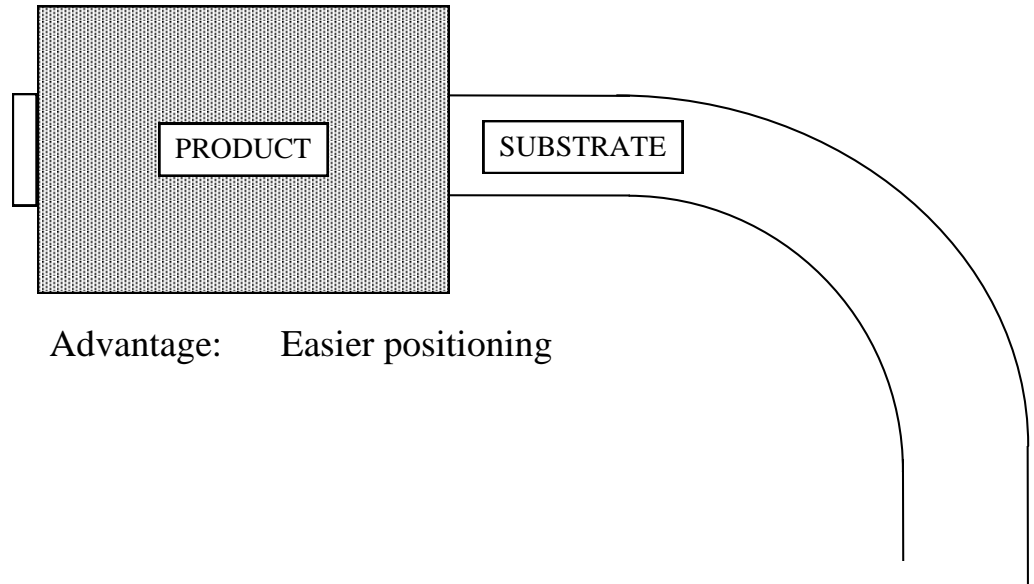

Advantage: Easier positioning

B) Small product size

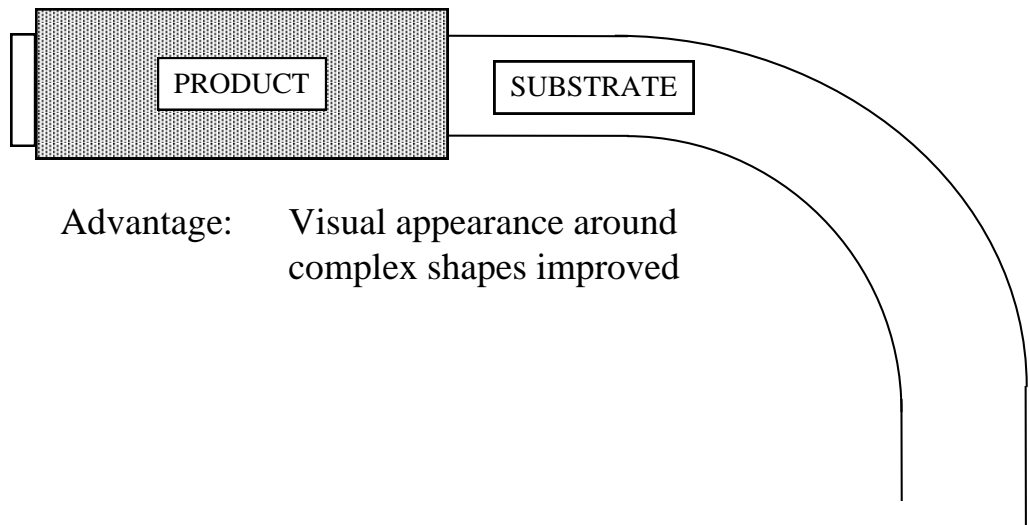

Advantage: Visual appearance around complex shapes improved

Final size selection will depend on the specific application. However, for maximum abrasion performance it is recommended that the larger of any HFT product options should be selected.

The example shown on page 7 of this guide indicates how a HFT size may be chosen for a particular substrate size.

No:	PIP-035	Revision:	1	Dated:	September 1999
-----	---------	-----------	---	--------	----------------

**Figure 3 - Selection Guide HFT5000**

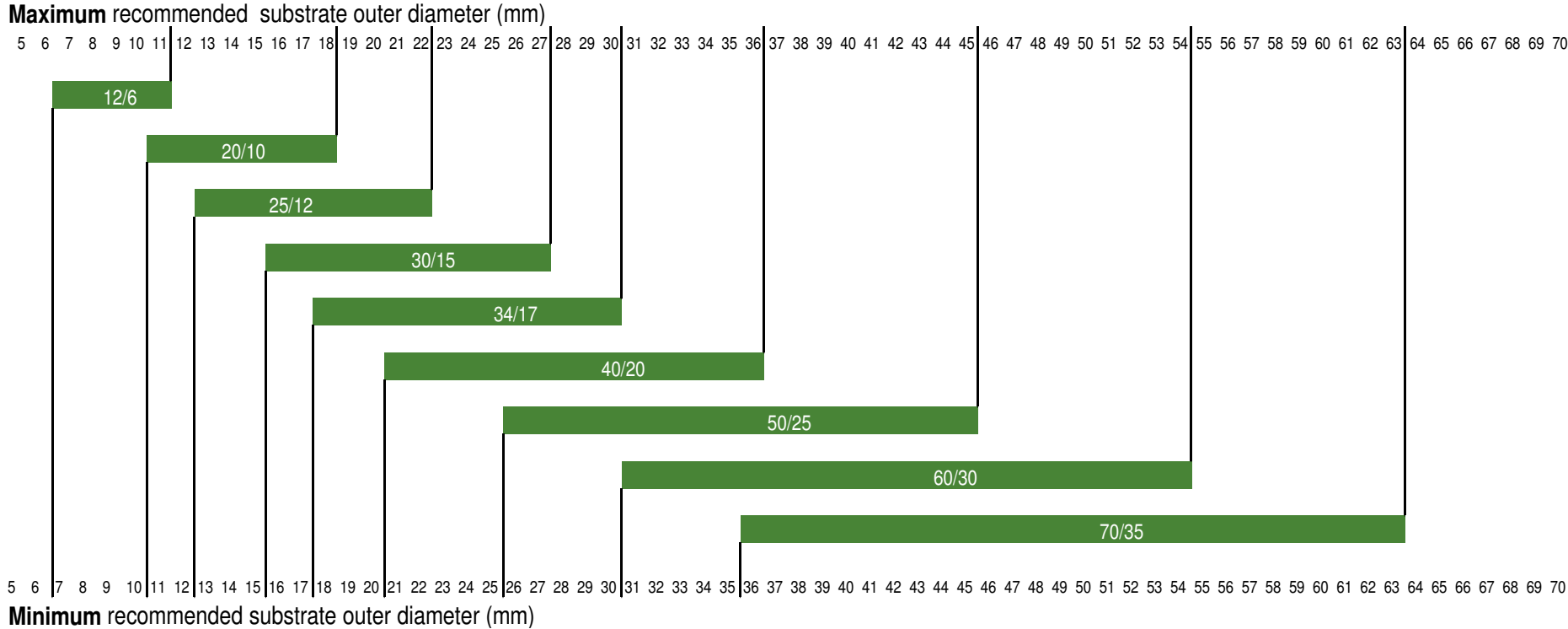

No:	TEC-114-120001	Revision:	A	Dated:	January 2018
-----	----------------	-----------	---	--------	--------------

**Size selection example**

**Substrate outer diameter = 33mm**

**Maximum recommended substrate outer diameter (mm)**

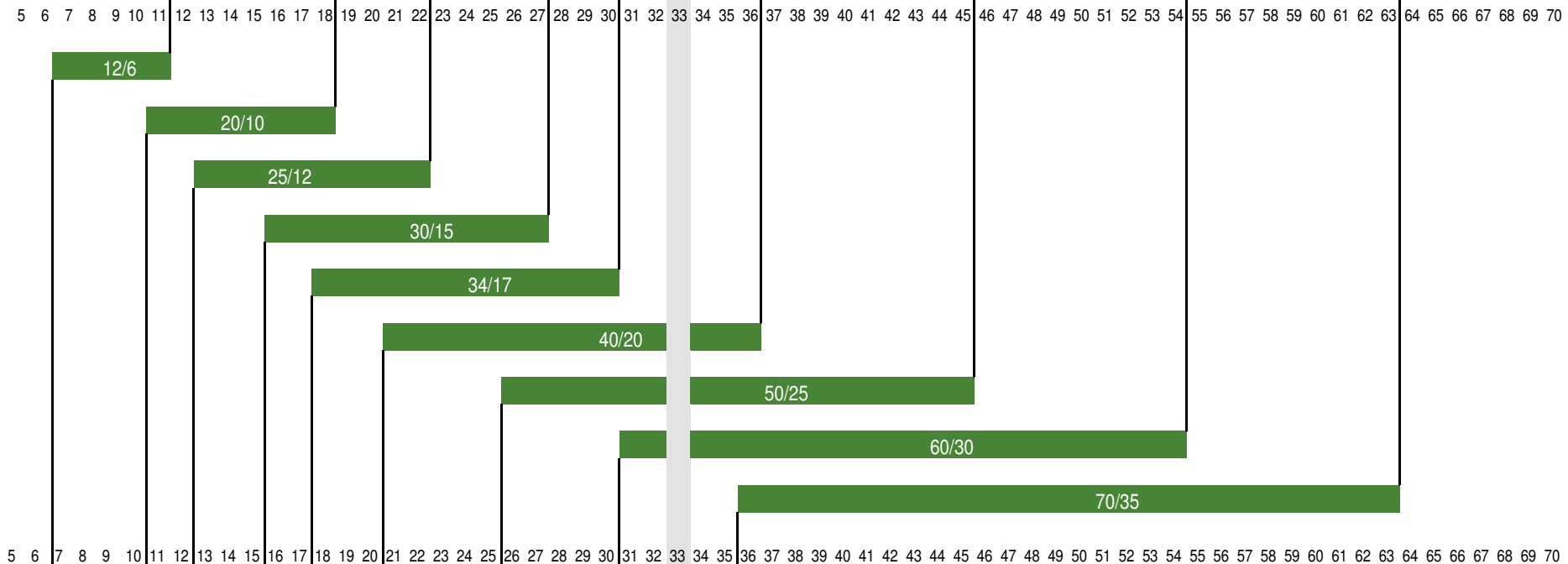

**Minimum recommended substrate outer diameter (mm)**

As shown above 3 possible sizes of HFT could be selected :

- i) HFT5000-40/20-0 In general this size would:
  - ◆ after installation have the best visual appearance (least wrinkled) around tight bends and complex shapes
- ii) HFT5000-50/25-0 In general this size would:
  - ◆ the best initial choice, being expected to give easy positioning onto the substrate prior to shrinkage and good visual appearance and performance after installation.

If positioning is difficult and slow try the larger size, if visual appearance could be improved try the smaller size.
- iii) HFT5000-60/30-0 In general this size would:
  - ◆ give the easiest positioning over the substrate prior to shrinkage
  - ◆ give the optimum protection.

## 5 Selection of Product Cut Length

When selecting the length of product to cut, consider:

- ◆ The area of the substrate to be protected from abrasion
- ◆ The length of change that can occur in the product during installation
- ◆ The substrate shape

### 5.1 Cut Length Selection

It is recommended that the product length selected is **not less than 50mm**. Small lengths - especially of large diameter products - must be handled carefully to prevent distortion and damage prior to shrinkage.

### 5.2 Longitudinal Shrinkage

During installation the HFT product will reduce in length. The amount of length change is dependent on the product size and substrate diameter. Figure 4 is a guide to show how the installed product length will change when installed onto different diameter substrates. The actual installed product length will also be affected by the complexity of the substrate. Therefore, it is recommended that this is used only as a guide and that trial installations are undertaken to determine the cut length required to give the desired installed product length.

FIG 4

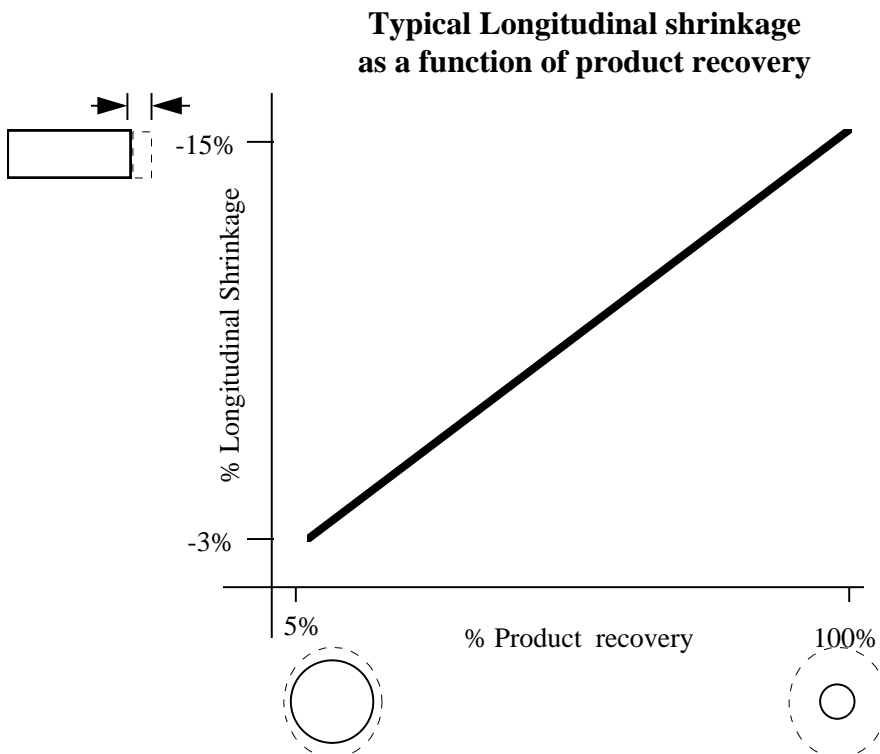



No:	TEC-114-120001	Revision:	A	Dated:	January 2018
-----	----------------	-----------	---	--------	--------------

Another factor that will influence the installed length of the HFT protective tubing is number and severity of bends to be covered on the substrate (see figure 5). It is recommended that trial installations are carried out to determine the correct cut length to give the required protected area after positioning and installation.

FIG 5

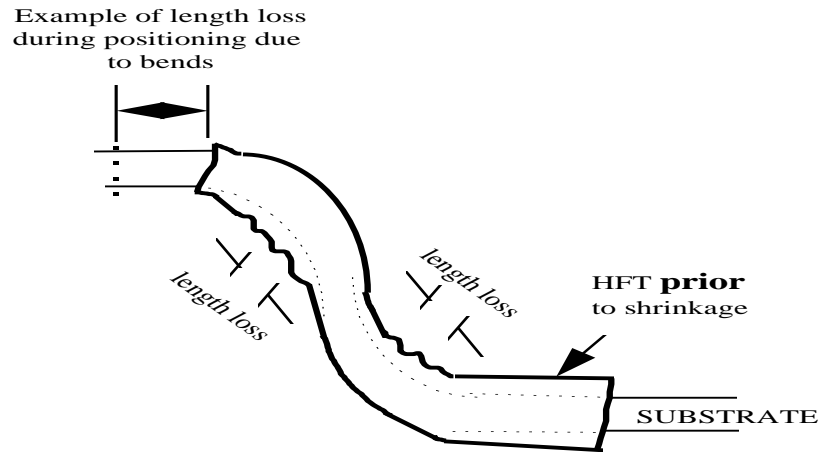

No:	TEC-114-120001	Revision:	A	Dated:	January 2018
-----	----------------	-----------	---	--------	--------------

## 6 Cutting of HFT5000

HFT5000 has been designed to cut with sharp shear action straight blades. HFT products contain fine filaments or fibres that can be cut effectively and reproducibly on shear-action cutting machines provided the following recommendations are considered.

Section 6.6 suggests a suitable machine for cutting HFT5000

### 6.1 Blade Clearance

HFT5000 can be cut using a sharp shear/guillotine action blade, or sharp well adjusted scissors. The correct setting of the top and bottom blade is essential to achieve a clean cut through the product.

The top and bottom blades must have zero clearance, wiping against each other during the cutting action (see figure 6). A gap between the top and bottom blades will result in the HFT product folding down between the two blades giving a poor cut.

FIG 6

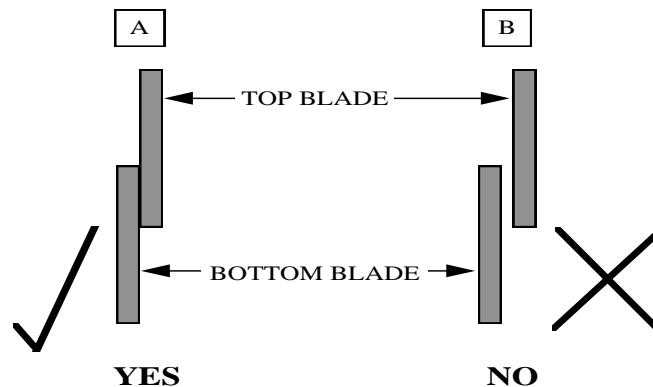

It is recommended that a high quality ground flat stock tool steel material is used for the cutting blade, which has been subsequently heat treated to give a Rockwell C hardness of 58 to 61.

### 6.2 Product Payoff

It is recommended that the product is fed into the cutting machine from a freely rotating payoff mechanism which has the capability of being braked.

If feed of the product off the spools is erratic it is suggested that the payoff braking mechanism is applied until a smooth running system is obtained.

**Note:** excessive braking could adversely effect the ability of the cutting machine to consistently pull product through the machine.

No:	TEC-114-120001	Revision:	A	Dated:	January 2018
-----	----------------	-----------	---	--------	--------------

### 6.3 Fabric Opening Aid

Figure 7 shows a method of aiding the opening of the HFT product. The system is intended to attach between the payoff and cutting guide system.

- ◆ HFT tubing is taken from the supply spool and twisted through 90° between roller sets 1 and 2.
- ◆ An opening device is introduced into the tubing between roller sets 2 and 3. (see figure 9).
- ◆ The opened tube is then flattened again through roller set 3 with the seam now in the middle. The flattening is required to enable the guide system described above to function. This flattening action also lightly creases the 'new' edges of the HFT tube which helps the cut pieces open up. (see figure 8).

**FIG 7 Plan View of Opening System Layout**

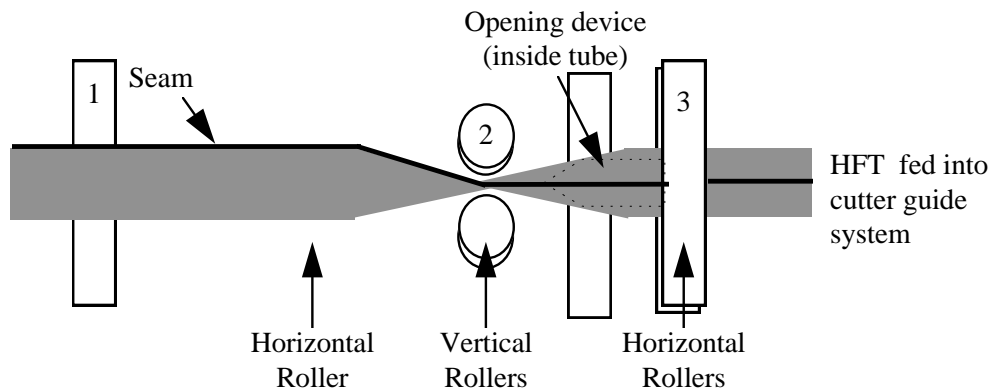

**FIG 8 - Typical Cut Piece after Being Through Opening System**

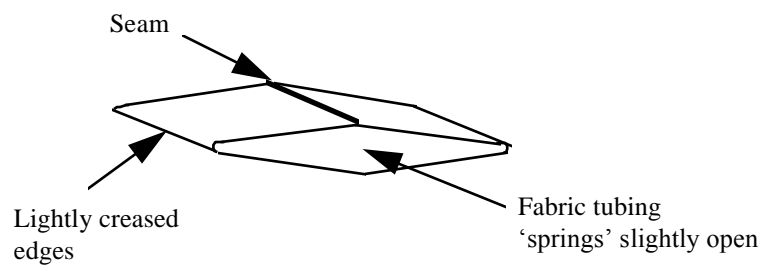

No:	TEC-114-120001	Revision:	A	Dated:	January 2018
-----	----------------	-----------	---	--------	--------------

**FIG 9 - Typical Opening Device**

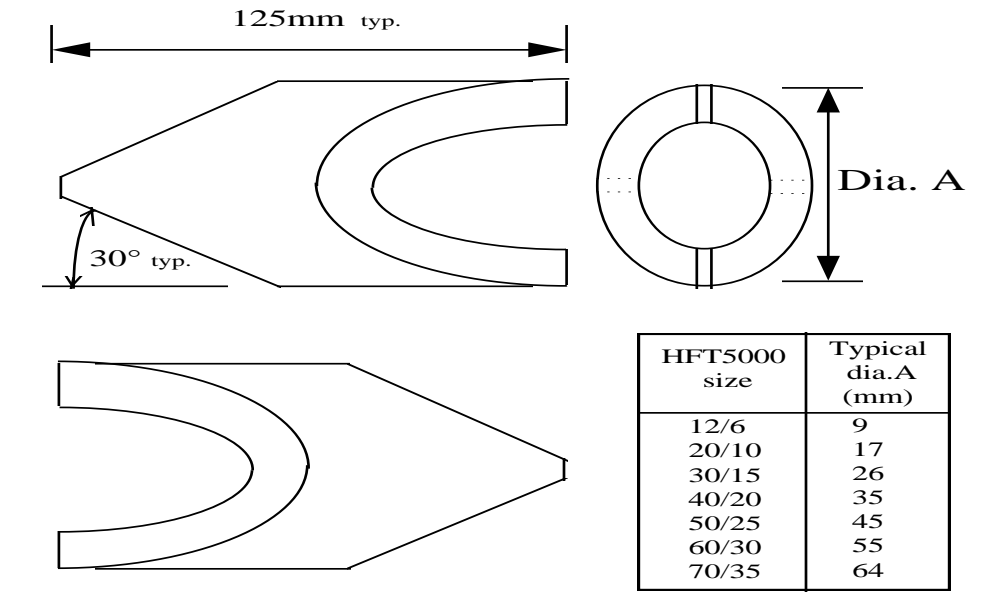

Figure 9 shows a typical opening device. This item consists of a cylindrical hollow part cut to a wedge shape at each end. The wedges are cut at 90° to each other.

#### **6.4 Regular Maintenance of Cutting Equipment**

To cut HFT consistently and reliably it is essential that the cutting equipment is in good working order. The condition and setting of the blades are especially important. It is therefore strongly recommended that regular maintenance and inspection of the cutting equipment is carried out.

#### **6.5 Safety**

Suitable guarding meeting local safety regulations should be fitted to all cutting machines.

#### **6.6 Suggested Equipment**

Metzner Model no. CL 150/30/B

This machine has encapsulated precision ball-bearing guides ensuring accurate top and bottom blade alignment. The control systems available for this machine will give a range of cut length tolerances.

The best configuration found for this machine is:

- ◆ a driven bottom feed band.
- ◆ a driven top feed roller. (Synchronized with bottom band feed)

Modifications or additions to above machine are:

- ◆ Fabric opening device (as section 6)

No:	TEC-114-120001	Revision:	A	Dated:	January 2018
-----	----------------	-----------	---	--------	--------------

## 7 Positioning of HFT on the Substrate

### 7.1 Possible Methods

Two methods could be used when positioning HFT5000:

1. Sliding the product over the substrate, with the substrate in its final shape
2. Sliding the product over a straightened substrate.

The method required will depend on the HFT size/substrate diameter and the complexity of the substrate to be protected.

### 7.2 Handling

As HFT5000 is a flexible product it is easier to pull the product into position over the substrate rather than push. This can be achieved by either pulling on the edges of the HFT tube or gently grasping the tube at one end to maintain an open tube whilst pulling into position. If the opening device described in section 6 is not used gentle pressure on the edges of the fabric will open the tubing. Gentle flattening of the opened tube to produce light creases in the fabric will result in product which can be easily positioned onto the substrate. See figure 10.

Care should be taken not to unduly deform the HFT5000 in this operation.

Care should also be taken to ensure that no sharp edges or points push through the HFT wall when inserting a substrate.

FIG 10

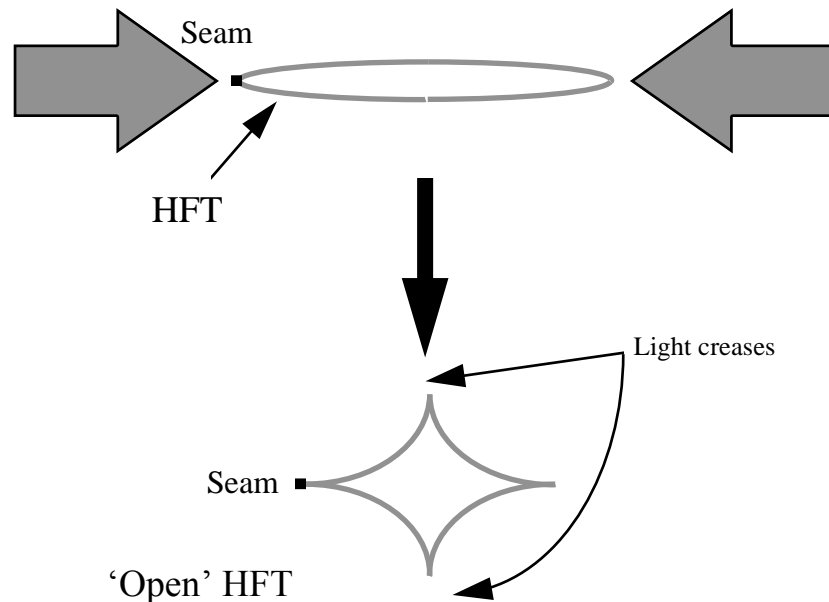

### 7.3 HFT Seam Alignment

If the HFT5000 is installed whilst excessively twisted, wrinkling, especially inside tight bends, will occur. The seam on the edge of the HFT tubing can be used as an indicator to show how straight the tubing is during positioning onto the substrate. It is recommended

No:	TEC-114-120001	Revision:	A	Dated:	January 2018
-----	----------------	-----------	---	--------	--------------

that the seam on the HFT5000 is as straight as possible prior to shrinking the product down onto the substrate.

## 8 Shrinking HFT5000

HFT5000 can be installed using air circulating ovens, tunnel ovens, hot air guns, or infra-red installation tools.

### 8.1 Air Circulating Ovens

When using hot air circulating ovens the range of temperatures that can be used is shown in figure 11. The time to fully install the product will depend on:

- a) the ability of the oven to regain the desired temperature after opening
- b) the size and mass of the substrate onto which the product is being recovered

FIG 11

### PRODUCT INSTALLATION TEMPERATURE RANGE (Air temperature, air circulating ovens)

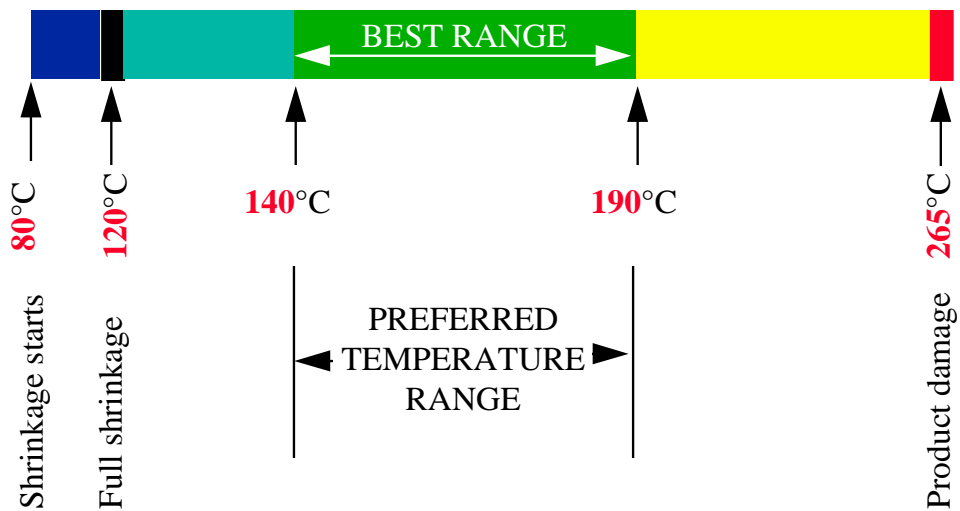

Typical installation conditions in an air circulating oven are:

10 minutes at 140 - 190°C (*onto vulcanised rubber substrate*)

For products installed on large diameter substrates increased times and/or temperatures maybe required. However, excessive times or temperatures may result in reduced overall product performance.

No:	<b>TEC-114-120001</b>	Revision:	<b>A</b>	Dated:	January 2018
-----	-----------------------	-----------	----------	--------	--------------

## 8.2 Tunnel Ovens

A wide range of shrink tunnel ovens are commercially available typically with heating zone lengths of between 1 to 2.5 metres. The heat distribution around the product should be as even as possible.

Typical machine settings for tunnel ovens with heating zones of between 1 to 1.5 metres are:

Typical Oven Temperature setting 250 to 275°C  
Typical Belt speed 0.5 to 1 m/min.

Design and temperature of tunnel oven should take into account any heat sensitive component parts of the substrate. It is recommended that trial installations are carried out for each oven type and application to determine the optimum installation parameters.

Suppliers of tunnel ovens include:

A&C (Lyon, France)  
SAHA (Barcelona, Spain)

## 8.3 I.R. Tunnel Ovens

HFT products can be installed using infra-red ovens. The heat distribution around the product should be as even as possible to prevent localised scorching of the HFT product.

The power setting and time within the heating zone will depend on the equipment chosen, product size and nature of the substrate.

The 'TE Connectivity' recommend equipment for HFT5000 installations is the 'Model-105' tunnel oven. PCN : 955018-000.

## 8.4 Hot Air Gun Installation

- ♦ Use a low power heat gun with suitable reflector to provide even heat distribution and to prevent localised scorching or splitting.
- ♦ Use a shrink temperature of approximately 160-200°C and do not exceed 250°C. The exact temperature and heating time will depend on the type of hot air gun, reflector, product size and substrate.
- ♦ Carefully shrink the product from one end to the other. Do not continue to heat the product once fully recovered.
- ♦ A Raychem temperature controlled heat gun with a suitable reflector is recommended.



No:	<b>TEC-114-120001</b>	Revision:	<b>A</b>	Dated:	January 2018
-----	-----------------------	-----------	----------	--------	--------------

***Remember:***

*Basic safety precautions should be followed when heating polymeric materials to high temperatures. See Raychem Safety Data Sheet RAY3145-EC.*

*Good housekeeping around heating equipment is important - accumulation of polymeric fibres or dust should be regularly cleared away from heat sources.*