

The product described in this document has not been fully tested to ensure conformance to the requirements outlined below. Therefore, TE Connectivity (TE) makes no representation or warranty, express or implied, that the product will comply with these requirements. Further, TE may change these requirements based on the results of additional testing and evaluation. Contact TE Engineering for further details.

PN	Description
1897223-2	CAP HSG ASS'Y FOR HYB(040/090) DOOR 30P
1897228-2	PLUG HSG ASS'Y FOR HYB(040/090) DOOR 30P

1 Scope

2 Quality

3 Requirements

4 Requirements Measuring Method

- 4.1 Appearance
- 4.2 CONN engage and disengage force
- 4.3 Reverse insertion between housing
- 4.4 Reverse insertion between terminal and housing
- 4.5 Engage force between terminal and housing
- 4.6 HSG Lock strength
- 4.7 HSG Lock releasing force
- 4.8 Terminal retention force
- 4.9 Terminal engage and disengage force
- 4.10 Crimp strength
- 4.11 Voltage drop
- 4.12 Insulation resistance
- 4.13 Leakage current
- 4.14 High voltage test
- 4.15 Temperature rise
- 4.16 Instant short circuit
- 4.17 CONNECTOR coupling sound

4.18 Plate Retention

5 Test conditions

5.1 specimen

5.2 Laboratory condition

5.3 Basic current

5.4 Evaluation

5.5 Cable size

6 Test Method

6.1 Connector endurance test (Twisting test + CONN Engage / Disengage endurance test)

6.2 Overcurrent cycle test

6.3 Cold temperature test

6.4 Cold and hot temperature shock test

6.5 High temperature test

6.6 Temperature and humidity cycle test

6.7 Dust test

6.8 Oil and liquid test

6.9 Ozone test

6.10 Sulfur(SO₂) gas test

6.11 Mechanical shock test

Complex environment endurance test A

1. SCOPE

This SPEC defines the test method for low voltage connectors (connector) and low voltage terminals

(terminal).

* **Related specification: ES91500-00**

2. Quality

The quality of connector have to meet each characteristics at column 3 with items of test in table 1.

3. Requirements

NO	items	characteristics	Measuring method		
1	Appearance	No harmful crack, rust, burr, damage, deformation, discoloration etc.	4.1		
2	CONN engage And disengage Force	7.6kgf of less	4.2		
3	Reverse insertion Between housing	It shall not be incorrectly inserted and flowed current between terminals by housing deformation on applying force of 20kgf.	4.3		
4	Reverse insertion between terminal and housing	025 : 3kgf or more , 060 & 110 : 5kgf or more	4.4		
5	Engage force between terminal and housing	025 : 0.8kgf or less , 060 & 110 : 1.5kgf or less	4.5		
6	HSG lock strength	10kgf or more	4.6		
7	Lock release force	Force on release force point of lock part shall be 0.5~6kgf	4.7		
8	Terminal retention force	Terminal type	025 060 110	4.8	
		After engage TPA	6kgf or more 8kgf or more 10kgf or more		
		Before engage TPA	3.5kgf or more 3.5kgf or more 6kgf or more		
9	Terminal engage and disengage force (kgf)	Terminal type	025 060 110	4.9	
		Engage	0.1~0.5 0.2~0.8 0.3~1.5		
		Disengage	0.1~0.5 0.15~0.8 0.15~1.5		
10	Crimp strength (kgf)	SQ	0.22 0.3 0.5 0.75 0.85 1.25 2.0 2.5 3.0 5.0 8.0	4.10	
		(Kgf) or more	4 6 9 11 13 17 20 25 35 40 50		
11	Voltage drop	Division	Initial	After endurance	4.11

		025	10 mV/A or less	20 mV/A or less	
		060	5 mV/A or less	10 mV/A or less	
		110	3 mV/A or less	10 mV/A or less	
12	Insulation resistance	Division	Initial	After endurance	4.12
		waterproof	100M Ω or more	100M Ω or more	
13	Leakage current	Division	Initial	After endurance	4.13
		waterproof	1 μ A or less	1 μ A or less	
14	High voltage test	There shall be no insulation break.			4.14
15	Temperature rise	Division		After endurance	4.15
		General CONNECTOR		40°C or less	
16	Instant short circuit	There shall be no 10 μ s or more instant short circuit.			4.16
17	Connector coupling sound	65 dB(A) or more			4.17
18	Plate Retention	Retention force		Escaping force	4.18
		5 kgf or more		3 kgf or more	

< Table 1 >

4. Requirements Measuring Method

4.1 Appearance

By sense of sight and touch.

4.2 CONNECTOR engage and disengage force

Measure force by engaging and disengaging the connector with terminal assembled at constant 50 mm/min speed. However, remove lock part when measuring disengage force.

4.3 Reverse insertion between housings

- 1) Insert terminal to housing
- 2) Fix housing of female connector to moving part of measuring instrument in reverse insertion direction. (Reverse insertion: 180 degree rotation on the locking part)
- 3) Set a measuring instrument to stop at force of 20kgf and insert that. At this moment, monitor resistance of one terminal matched to identify current carrying between terminals.
- 4) Check the insertion by housing modification of male connector after connector insertion.

4.4 Reverse insertion between terminal and housing

Crimp cable of maximum size on terminal and then, insert it into housing by the end of insulation.

4.5 Engage force between terminal and housing

As shown in the following figure 4-1, measure the weight while inserting terminal into fixed housing at 50mm/min speed.

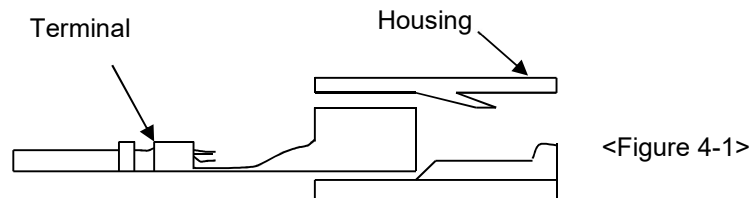

4.6 HSG Lock strength

Combine housing only, fix the one side of housing in completely locked condition, and extend the other side in axial direction and 30 angle direction at a constant speed of 100mm/min. Then measure weight when lock structure is disengaged or destroyed.

4.7 HSG lock releasing force

Apply force (F) to lock releasing part, and measure weight on the point of A=0. However, cut connector and then perform test at the section in order to secure visibility.

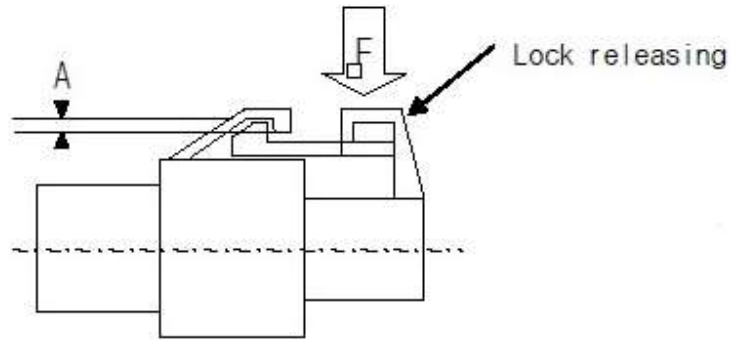

<Fig. 4-2>

4.8 Terminal retention force

Fix the housing after inserting crimped terminals. Extend one line of cable in axial direction at a speed of 50mm/min at a position 50±5 mm away from crimped part, and measure weight when terminal is disengaged from the housing.

4.9 Terminal engage and disengage force

As shown in figure 4-3, engage and disengage male terminal or steel gauge into or from female terminal at 50 mm/min speed.

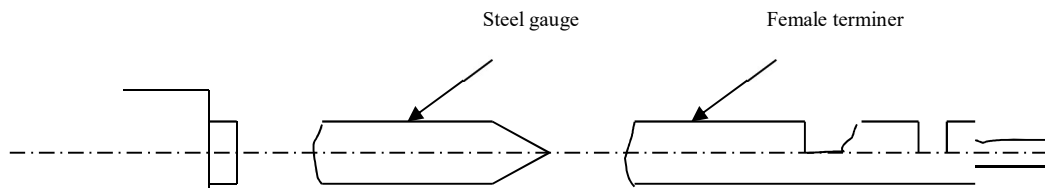

< Fig. 4-3 >

4.10 Crimp strength

Fix the crimped terminal, and draw the cable at a position 50±5 mm away from crimped part in axial direction at 100 mm/min speed. Then measure the weight when cable is cut or disengaged from the crimped part.

4.11 Voltage Drop

Measure the circuit voltage drop (V) by sending voltage and current described in the table 2 with terminal combined on the connector. Then calculate a voltage drop (V_D) in terminal by subtracting cable resistance (L) from the circuit voltage drop (V).

1) HARNESS vs. HARNESS : $V_D = V - (L_1 + L_2)$

2) HARNESS vs. UNIT : $V_D = V - (L_3 + L_4)$

Application	Open voltage	Short circuit current	Division
Signal circuit	20 ± 5mV	10 mA	ECU, Sensor
Power circuit	13 V	1 A	Other than the above

< Table 2 >

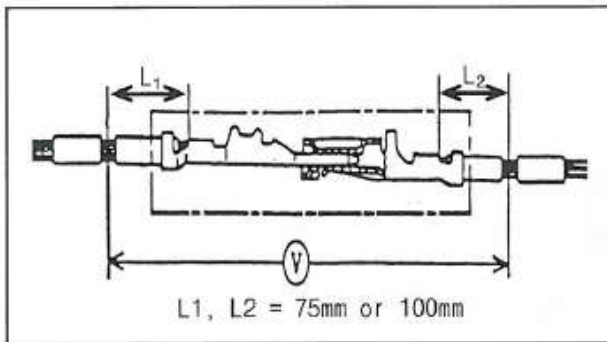

< Fig. 4-4 : HARNESS vs. HARNESS >

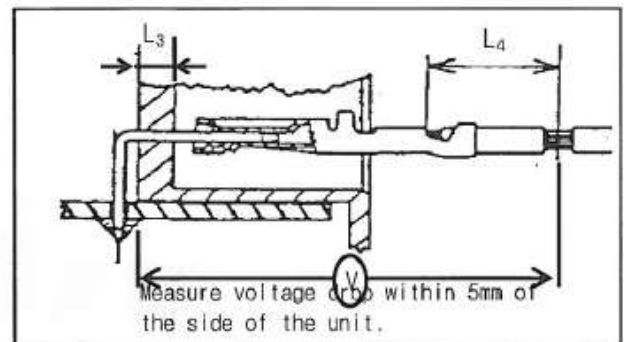

< Fig. 4-5 : HARNESS vs. UNIT >

4.12 Insulation resistance

Measure resistance between neighbor terminals (figure 4-6), and between terminal and housing surface (figure 4-7) with DC 500V insulation resistance gauge with connector combined.

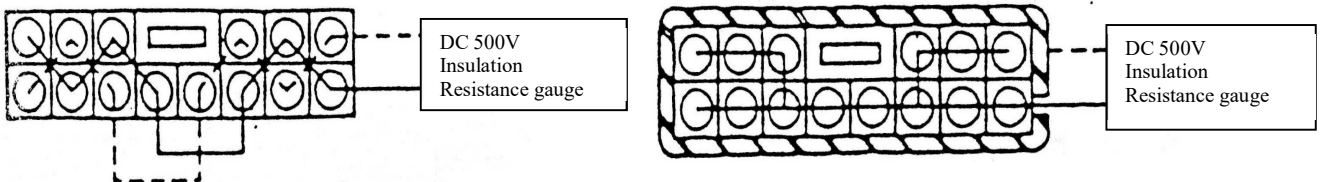

<Fig. 4-6: Between neighboring terminals> <Fig. 4-7: Between neighboring terminal and housing surface>

4.13 Leakage current

Measure it by applying DC 14V between neighboring terminals (figure 4-6).

4.14 High voltage test

Apply AC 1000V voltage of normal frequency for 1 minute between neighboring terminals (figure 4-6), and between housing surfaces of terminal (figure 4-7), with connector combined.

4.15 Temperature rise

Apply basic current ($I=I_0 \times K$) of clause 5.3 to the connector with electrodes in series in the room free from wind (normal temperature). And measure a temperature of crimped part after reaching saturation temperature. Then calculate a temperature of crimped part by subtracting ambient temperature from the temperature.

4.16 Instant short circuit

It is instant short circuit, when 3.5V or less voltage continues for 10 μ s or more in gauge by applying 1mA, 5V open voltage. Figure 4-8 is an example of measured circuit.

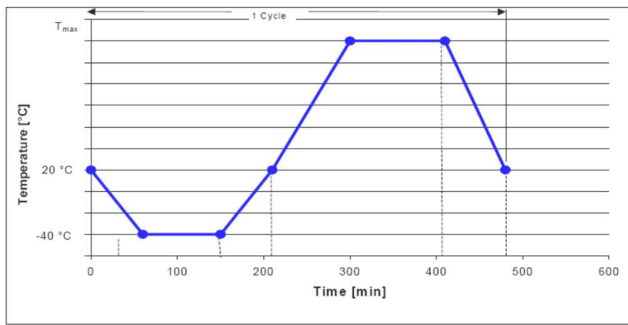

Duration Min	Temperature °C
0	20
60	-40
150	-40
210	20
300	T _{max} * (see table 6)
410	T _{max} * (see table 6)
480	20

<Table 2-1>

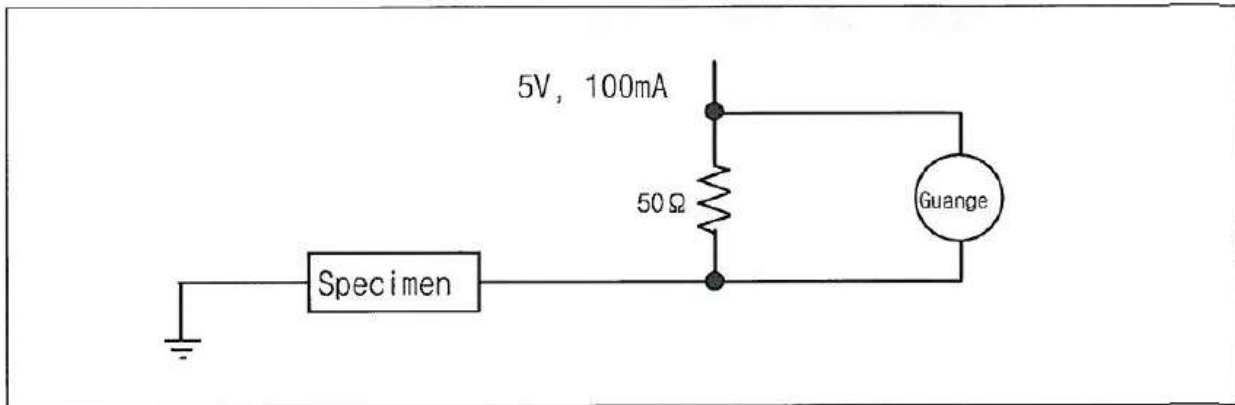

<Fig. 4-8>

4.17 Connector coupling sounds

Put sound measurement equipment on 700±10 mm away from the connector. Measure the peak sound that occurs when you combine the connector. Sounds unit: dB(A)

4.18 Plate retention

- 1) Plate retention : after fixing connector that is combined with plate, push the center of plate with the round bar which has diameter less than 10mm by pressing the 50 mm/min. Measure the value of the plate when the lock off

- 2) Plate escape power : after fixing connector that is combined with plate, Connected by wire to the center of the plate. Pull the wires 50mm/min at a rate, measure the value when the plate is escaped.

5. Test conditions

5.1 Specimen

Unless there is specific mention, initial sample should use for the test specimen, and test specimen shall be 5EA or more for each cavity. However, if performance is expected to be clearly satisfactory ever by applying load to the same specimen in turn, it is possible to apply multiple test items to the same specimen. In such case, performance shall be satisfied with each item.

5.2 Laboratory condition

Perform each test at designated temperature and humidity. And control humidity at designated absorption ratio for the connector which uses absorbent resin housing.

Temperature: 25 ± 5 °C

Humidity: 60 ± 20 %

Standard absorption ratio (reference value)

6 NYLON: 2 ~ 4%

66 NYLON: 1.5 ~ 3%

5.3 Basic current

Basic current value "I" shall be based on the following. ($I = I_0 * K$)

Cable size (SQ)	I ₀		Remarks
	General	L TYPE -375	
0.22	4 A		
0.3	6 A		4A for signal
0.5	8 A		5A for signal
0.85	10 A		
1.25	14 A		
2	18 A		
3	22 A	34 A	
5	25 A	46 A	
8		60 A	

Number of simultaneous electrode within the same connector	K
	Reduction factor
1	1
2 ~ 3	0.75
4 ~ 5	0.6
6 ~ 8	0.55
9 ~ 10	0.5
11 ~ 25	0.4
26 or more	0.3
-	-

< Table 3.1 >

< Table 3.2 >

5.4 Evaluation

Evaluation shall be represented by evaluation applicable connector. And Annual evaluation of connectors shall be represented by evaluation of connectors of the maximum number of poles in the same series.

5.5 Cable size

The size of connector lead wire used in each test shall be follow Table 4.

Test Item		MIN WIRE	MAX WIRE	Test Item	MIN WIRE	MAX WIRE	
CONN engage And disengage Force		-	0	High temperature test	Voltage Drop	-	0
	Reverse insertion between housing	-	0		Sealing	0	0
CPA engage and retention forces		-	-	Soldering test		-	-
Reverse insertion between terminal and housing		-	-	Temperature and humidity cycle test	Voltage Drop	-	0
Engage force between terminal and housing		0	-		Insulation resistance	0	0
CONN'R CLIP engage and disengage force		-	-		Leakage current	-	0
HSG lock strength		-	-		Sealing	0	0
HSG Lock release force		-	-	Dust test	Voltage Drop	-	0
Terminal retention force		-	0		Sealing	0	0
Terminal engage and disengage force		-	0	Waterproof test	Insulation resistance	-	0
Crimp strength		0	0		Leakage current	-	0
Voltage drop		-	0		Sealing	0	0
Insulation resistance		-	0	Oil and liquid test	Voltage Drop	-	0
Leakage current		-	0		Sealing	0	0
High voltage test		-	0	Ozone test	Voltage Drop	-	0
CONN endurance test	Appearance	-	0		Sealing	0	0
	Voltage Drop	-	0	Salt water test	Voltage Drop	-	0
Overcurrent cycle Test	Appearance	-	0		Insulation resistance	-	0
	Voltage Drop	-	0		Leakage current	-	0
Cold temperature Test	Appearance	-	0		Sulfur test	Voltage Drop	-
	Voltage Drop	-	0	Sealing		0	0
	resistance		0	Mechanical shock	Instant	-	0

	Leakage current	-	O	test	short circuit			
	Temperature rise	-	O	Complex environment Endurance test	Crimp strength	O	O	
	Sealing	O	O		Voltage Drop	-	O	
Cold and hot Temperature test	Voltage Drop	-	O		Temperature rise	-	O	
	Sealing	O	O		Instant short circuit	-	O	
Connector coupling sounds			-		-	Sealing	O	O

< Table 4 >

6. Test Method

Test Items	Appearance	CONN engage and disengage Force	Reverse insertion Between housing	Reverse insertion between terminal and housing	Engage force between terminal and housing	HSG lock strength.	Lock release force	Terminal retention force	Terminal engage and disengage force (kgf)	Crimp strength (kgf)	Voltage drop	Insulation resistance	Leakage current	High voltage test	Temperature rise	Instant short circuit	CONNECTOR coupling sound	Plate retention
Initial test	0	0	0	0	0	0	0	0	0	0	0	0	0	0			0	0
Connector twisting test	0										0							
Engage / Disengage endurance test	0										0							
Overcurrent cycle test	0										0				0			
Cold temperature test	0										0	0	0		0			
Cold and hot temperature shock test	0										0							
High temperature test	0										0							
Temperature and humidity cycle test	0										0	0	0					
Dust test											0							
Oil and liquid test	0										0							
Ozone test	0										0							
Sulfur test	0										0							
Mechanical shock test																	0	
Complex environment endurance test A										0	0				0	0		

< Table 5: Test items >

6.1 CONN endurance test (Twisting test+ CONN engage/Disengage endurance test)

Apply 8kgf on the end part of combined connector 10 times each in the (front, rear, left, right) directions perpendicular to axial direction.
 And make combine connectors engage and disengage. Perform it 50 times.
 (Do not use locking device)

6.2 Overcurrent cycle test

Engage and disengage connector with terminal assembled 10 times with hands, and apply the following current 1000 cycles for the connector with electrodes in series at 60°C of ambient temperature.

6.3 Cold temperature test

Leave connector with terminal assembled in temperature chamber of -40°C for 120 hours and estimate below items for each sample dividing two groups.

- A. Estimate voltage drop and leakage current assembled connector.
- B. Leave connector for 2 hours and separate connector with male and female, and then drop it onto the concrete surface more than 10T from 1.5m height 3 items. The method of connector drop follows figure 6-1.

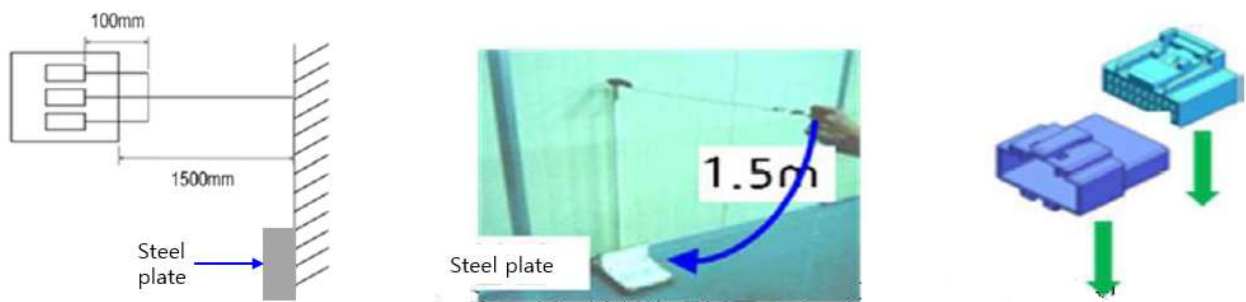

< Fig. 6-1 >

6.4 Cold and hot temperature shock test

Engage and disengage connector with terminal assembled 10 times with hands, and leave it in combined state at -40°C for 2hours, and perform 200 cycles according of the method specified in figure 6-1 and table 6. Then leave it at room temperature for 2 hours or more ((*) follows table 6.).

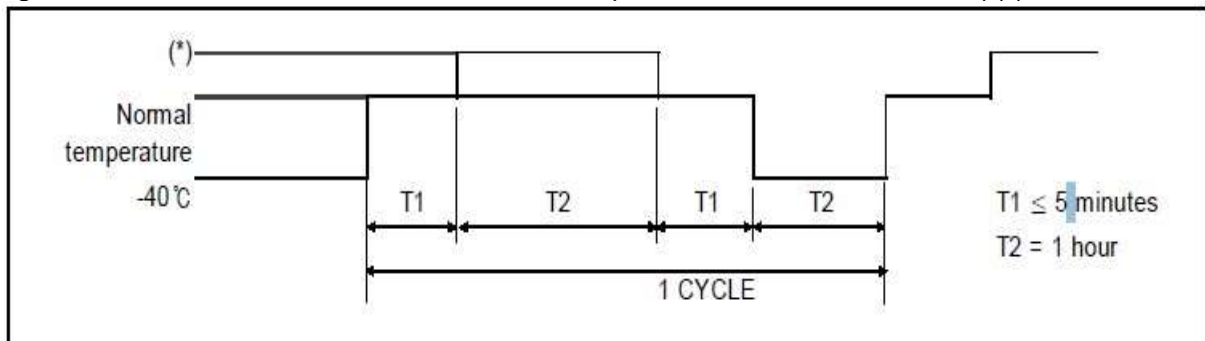

< Fig 6-2: Test pattern >

Division	High temperature (*)	Connector using part
A	120°C	ENG room
B	80°C	except ENG room

< Table 6 >

6.5 High temperature test

Engage and disengage connector with terminal assembled 10 times with hands, and leave it in combined state at the temperature chamber of the table 9 for 300 hours. Then pick it out and leave it until it returns to normal temperature.

6.6 Temperature and humidity cycle test

Engage and disengage connector with terminal assembled 10 times with hands, and leave it at 25°C ambient temperature and 65% relative humidity for 25 hours. And perform 5cycles of the method specified in figure 6-3. Then pick connector out of chamber and dry it for 2 hours or more.

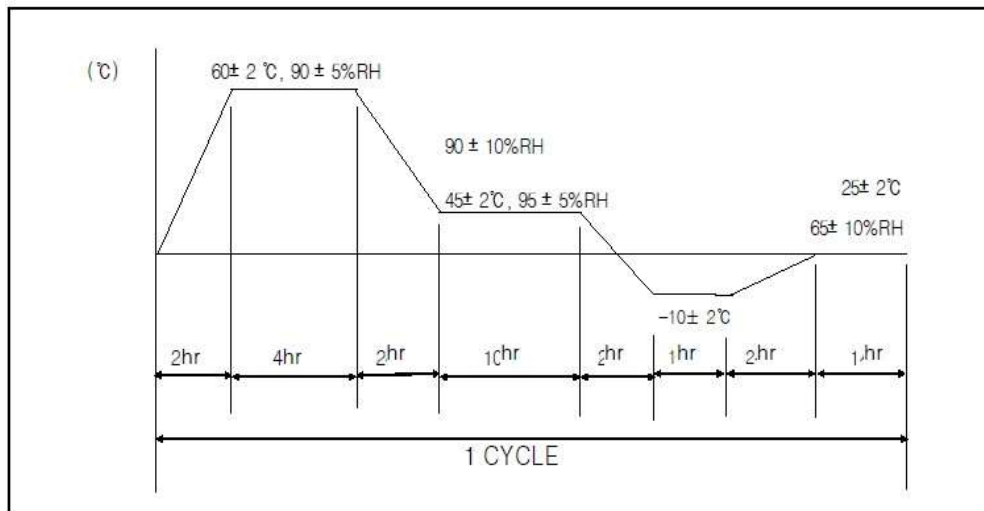

< Fig. 6-3 >

6.7 Dust test

Engage and disengage connector with terminal assembled 10 times with hands, and diffuse 1.5kg Portland cement(JIS R5210) with fan (or others) for 10 seconds per 15 minutes while maintaining 150mm distance from wall in the closed container of 900~1200mm length, width and height, with connector combined. After 1 hour, measure it.

6.8 Oil and liquid test

Engage and disengage connector with terminal assembled 10 times with hands, and perform test each sample with connector combined.

- A. Immerse connector in combined state for 2 hours in mixed oil of 50 ± 2°C ENG oil (SAE10W) or equivalent oil and
- B. Immerse connector in combined state for 1 hour in car gasoline (JIS K2202) at normal temperature, and then pick it out.
- C. Immerse connector in combined state for 1 hour in brake liquid (pure product) at normal temperature, and then pick it out.

- D. Immerse connector in combined state for 1 hour in 100% washer liquid (pure product) at normal temperature, and then pick it out.
- E. Immerse connector in combined state for 1 hour in 50% LLC (Long life coolant) at normal temperature, and then pick it out.

6.9 Ozone test

Engage and disengage Connector with terminal assembled 10 times with hands, and samples keep at 40°C and 50±5pphm Ozone for 100hour. Then pick connector out of chamber and dry it for 2hours or more.

6.11 Sulfur (SO₂) gas test

Engage and disengage connector with terminal assembled 10 times with hands, and expose it in combined state to sulfur gas of 40±3°C, density 10ppm, humidity 90~95%, for 24 hours. Then pick connector out of chamber and dry it for 2 hours or more.

6.12 mechanical shock test

Engage and disengage Connector with terminal assembled 10 times with hands, and apply 1960, 3920, 5880, 9822 m/s² shock in each direction of figure 20 and 21 using assembled male and female samples. Perform test in current application condition of DC13V open voltage and 10mA short circuit current.

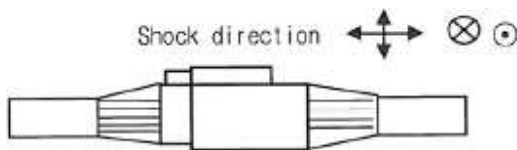

< Fig. 6-4 >

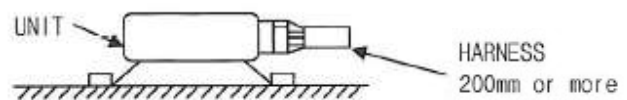

< Fig. 6-5 >

6.13 Complex environment endurance test A (Refer to the attached test process #1)

Engage and disengage connector with terminal assembled 10 times with hands, and leave it in combined state in the temperature chamber of 120°C or 80°C (follows table 7) for 48 hours.

And then perform the following vibration test. Then measure instant short circuit according to the method of clause 4.16 for 4 hours for X, Y, Z each.

Follow figure 6-6 for connector attaching method.

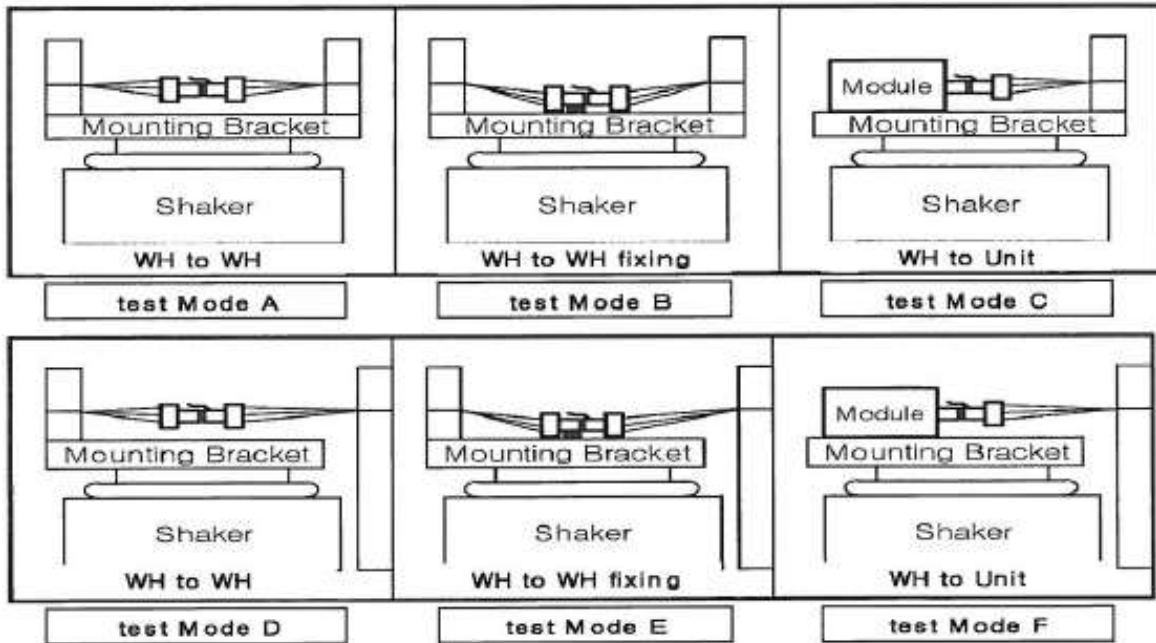

< Fig 6-6 Connector attaching method >

◆ Vibration test A (for non-waterproof connector)

Division	Condition
Ambient temperature/humidity	Refer to figure 12, 90~95%
Applied current	Basic current (Connector electrodes in series.)
Current application cycle	120 CYCLE (45 minutes-ON, 15 minutes-OFF)
Vibration acceleration	4.4g
Frequency	20Hz ~ 200Hz (sweep time: 3 minutes or less)
Vibration time	40 hours for X, Y, Z each
Connector attaching method	Test mode A, B, C

< Table 7 >

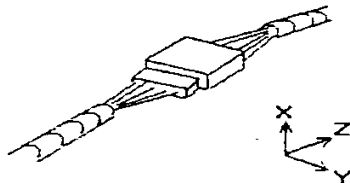

<Fig. 23 : X, Y, Z vibration direction>

Test process #1

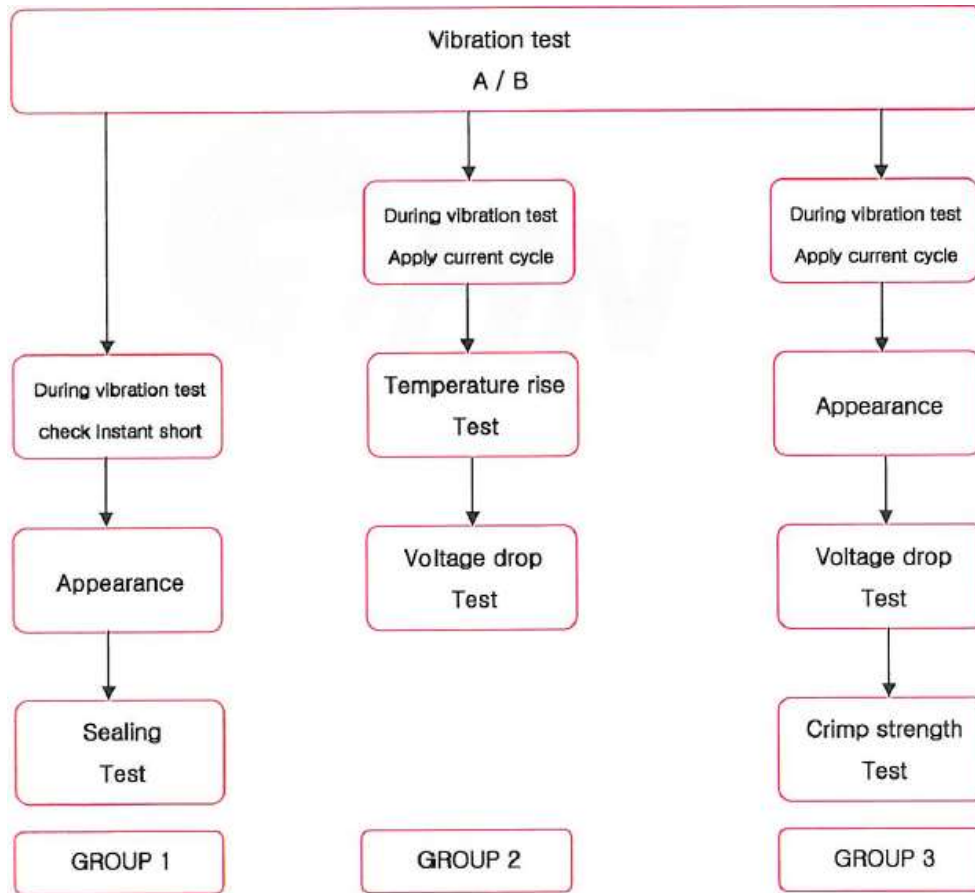

※ In the multipolar connector, Evaluation test at the same time for group 2/3

Rev	Change	Description	Date
A		Initial Released	20.MAR.'20

Prepared by, JH KIM	Checked By, GC KWON	Approved by GC KWON
Product Engineer	Senior Product Engineer	Product Engineering Manager