

CDFP Connector and Housing Assembly

NOTE

All numerical values are in metric units [with U.S. customary units in brackets]. Dimensions are in millimeters. Unless otherwise specified, dimensions have a tolerance of ± 0.13 and angles have a tolerance of $\pm 2^\circ$. Figures and illustrations are for identification only and are not drawn to scale.

1. INTRODUCTION

This specification covers the requirements for application of CDFP connector assemblies to interconnect CDFP fiber optic or copper transceiver modules to printed circuit (pc) boards. The CDFP connector assembly is available as Type 1 or Type 2.

The assembly features alignment posts and fasteners for mechanical retention to the pc board and to provide electromagnetic interference (EMI) suppression, panel ground features (panel ground Type 2 springs and Type 1 elastomeric gasket) to provide electrical contact to the bezel. In addition, the assembly has a locking latch and orientation keying for each mating module. The CDFP Connector Assembly is designed to be inserted into a bezel after being seated onto the pc board.

The connector consists of a housing with 120-position receptacle contacts and compliant pin contacts on 0.8 mm centerline spacing. The housing features alignment posts that provide stability for placement on the pc board. Each receptacle port has two card slots that accept a 1.0 ± 0.1 mm thick integrated circuit card housed in the mating module.

When corresponding with TE Connectivity Personnel, use the terminology provided in this specification to facilitate inquiries for information. Basic terms and features of this product are provided in Figure 1.

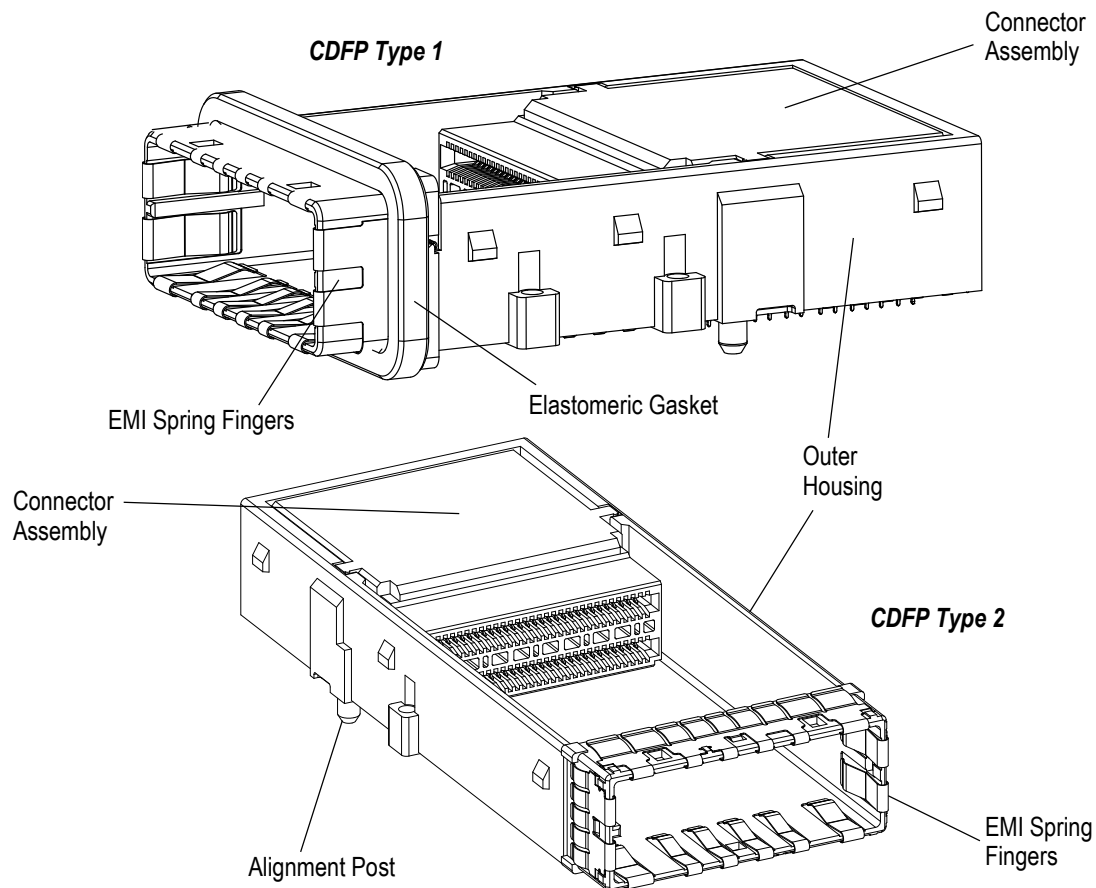

Figure 1

2. REFERENCE MATERIAL

2.1. Revision Summary

- Corrected product name in Paragraph 2.2

2.2. Customer Assistance

Reference Product Base Part Numbers 2274233, 2274383, and Product Code (L319) are representative of the CDFP connector assembly. Use of these numbers will identify the product line and expedite your inquiries through a service network established to help you obtain product and tooling information. Such information can be obtained through a local TE Representative or, after purchase, by calling Product Information at the number at the bottom of page 1.

2.3. Drawings

Customer drawings for product part numbers are available from the service network. If there is a conflict between the information contained in the Customer drawings and this specification or with any other technical documentation supplied, the information contained in the customer drawings takes priority.

2.4. Instructional Material

The following list includes available instruction sheets (408-Series) that provide assembly procedures for product, operation, maintenance and repair of tooling.

<u>Document Number</u>	<u>Document Title</u>
408-32136	CDFP Seating Tool Kit 2215034-1

2.5. Specifications

Product Specification [108-32065](#) provides product performance and test information for the CDFP connector assembly.

3. REQUIREMENTS

3.1. Safety

Do not stack component packages so high that the shipping containers buckle or deform.

3.2. Limitations

The connectors are designed to operate in a temperature range of -40° to 85°C [-40° to 185°F]. The bezel requirements given in this document are specifically configured for products used in the communications industry. It is strongly recommended that this bezel configuration NOT be used for peripheral component interconnect (PCI) applications.

3.3. Material

The connector housing and chicklets (parts that hold the compliant pin contacts) are made of molded thermoplastic, UL 94-V-0. All compliant pin contacts in the connector are made of copper alloy under-plated with nickel; plated with tin at the leads and plated with gold or gold equivalent at the interface area. The housing assembly is made of die cast zinc. The dust plug is made of die cast zinc.

3.4. Storage

A. Ultraviolet Light

Prolonged exposure to ultraviolet light may deteriorate the chemical composition used in the connector material.

B. Shelf Life

The connector assembly should remain in the shipping container until ready for use to prevent deformation to the compliant pin contacts and mounting posts. The connector assemblies should be used on a first in, first out basis to avoid storage contamination that could adversely affect performance.

3.5. Chemical Exposure

Do not store connector assemblies near any chemical listed below as they may cause stress corrosion cracking in the compliant pin contacts or mounting posts.

Alkalies	Ammonia	Citrates	Phosphates	Citrates	Sulfur Compounds
Amines	Carbonates	Nitrites	Sulfur Nitrites		Tartrates

3.6. PC Board

A. Material and Thickness

The pc board material shall be glass epoxy (FR-4 or G-10). The minimum pc board thickness shall be 1.57 mm.



NOTE

Contact Product Information at the number at the bottom of page 1 for suitability of other board materials.

B. Tolerance

Maximum allowable bow of the pc board shall be 0.08 mm over the length of the connector assembly.

C. Hole Dimensions

The holes for the connector signal contacts assembly must be drilled and plated through to dimensions specified in Figure 2.

D. Layout

The holes for the connector assembly must be precisely located to ensure proper placement and optimum performance of the connector assembly. Recommended hole pattern, dimensions, and tolerances are provided on the customer prints. Sample layouts are provided in Figure 3.

Recommended Hole Dimensions for Connector

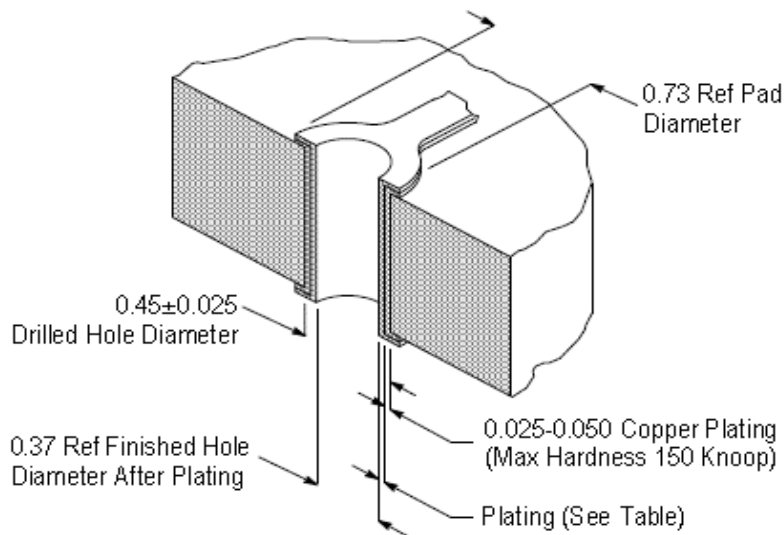

THICKNESS	PLATING
0.004-0.010	Hot Air Solder Leveling (HASL) Tin-Lead (Sn Pb)
0.0005-0.002	Immersion Tin (Sn)
0.0002-0.0005	Organic Solderability Preservative (OSP)
0.0001-0.0005 Au, 0.004-0.0076 Ni	Immersion Gold (Au) Over Nickel (Ni) (ENIG)
0.0001-0.0005	Immersion Silver (Ag)

Figure 2

CDFP Type 1 Footprint

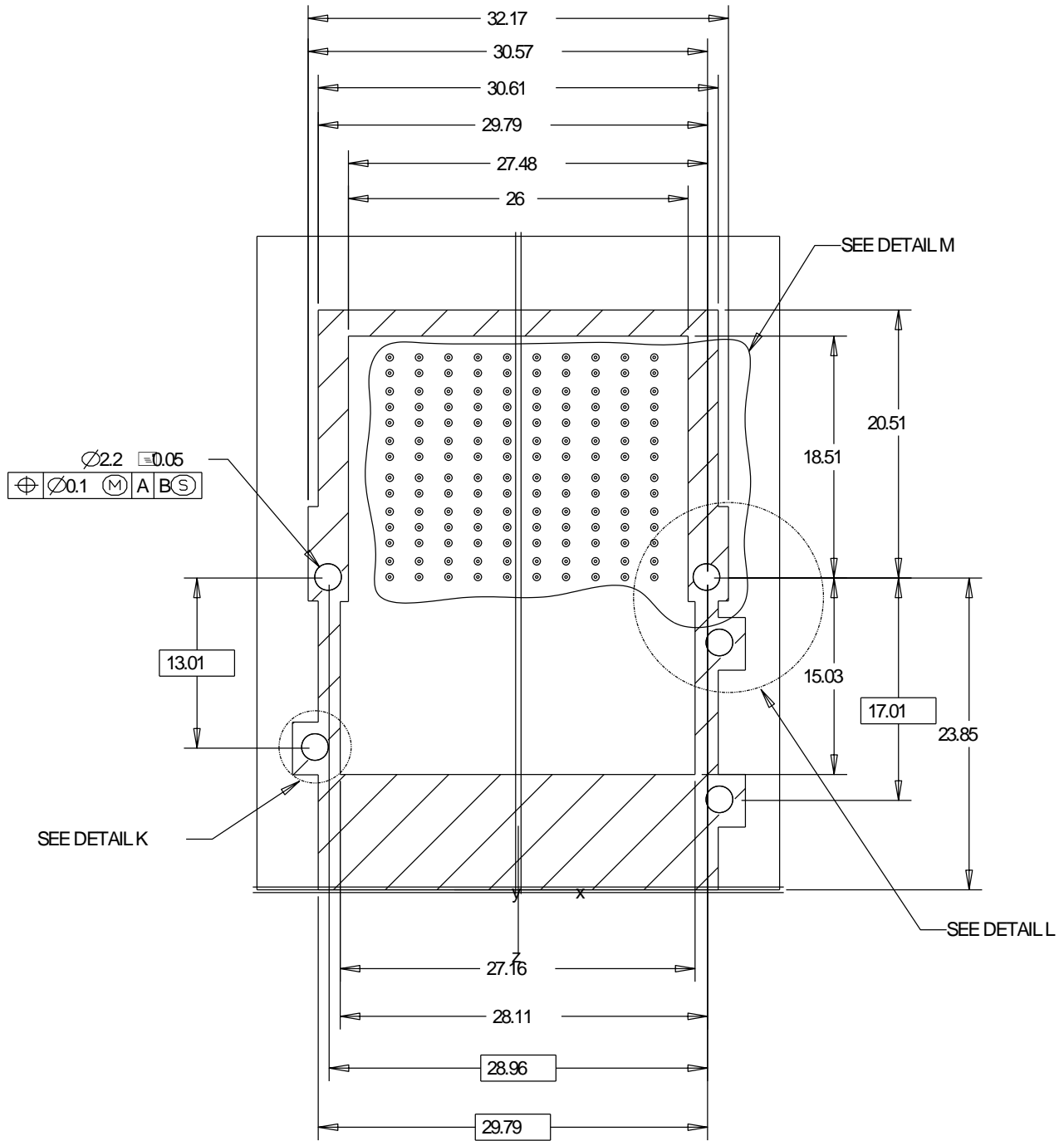

Figure 3 (cont'd)

CDFP Type 2 Footprint

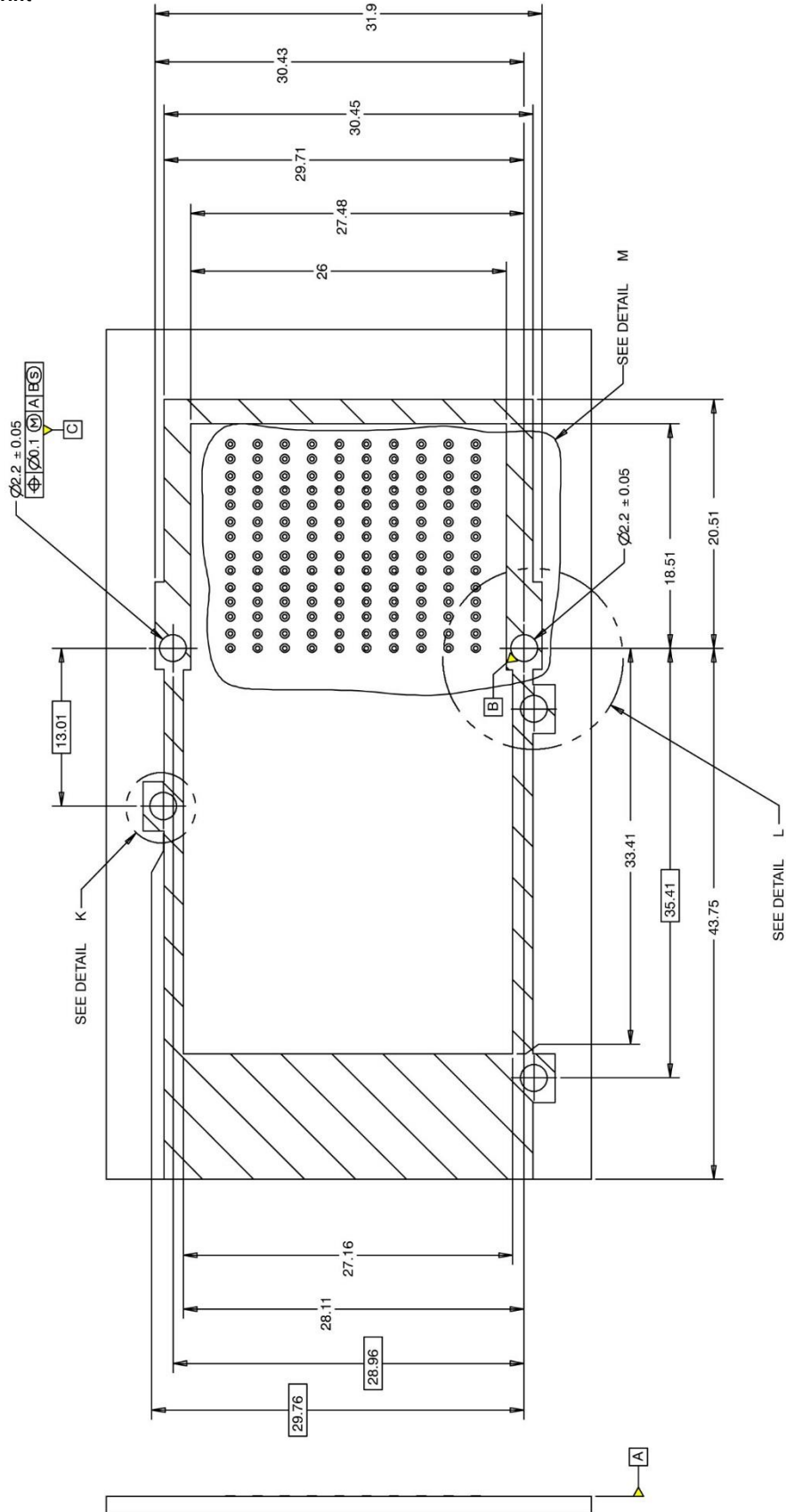

Figure 3 (cont'd)

Recommended Connector Layout (Type 1 and Type 2)

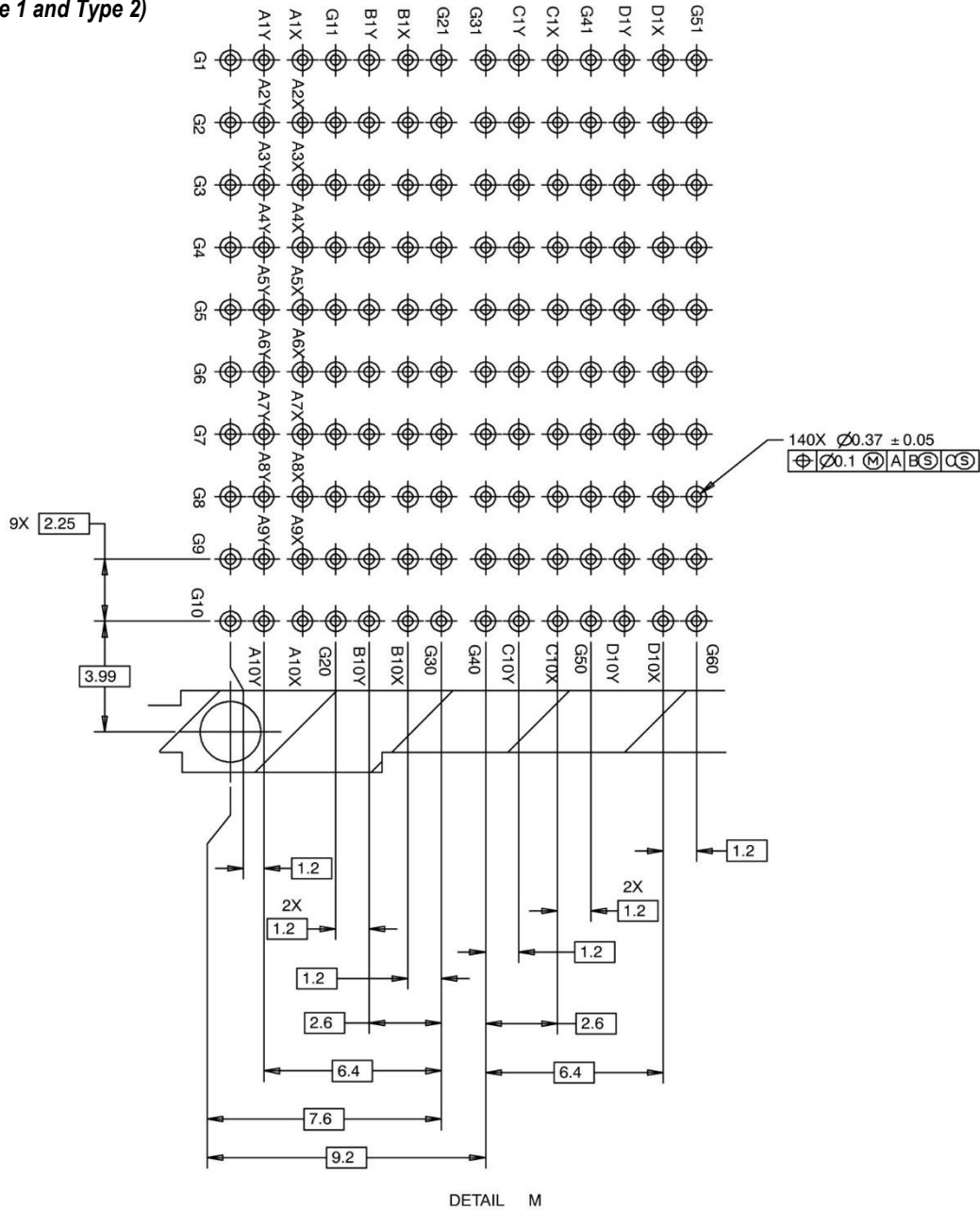

Figure 3 (end)

3.7. Transceiver Modules



CAUTION

The mating transceiver module packing size cannot exceed the width of each cage port opening. This includes the part of the transceiver that is extending outside the cage. This will prevent any possible interference when transceivers are inserted in adjacent ports.

3.8. Bezel

A. Thickness

The bezel thickness range shall be 0.8 through 2.6 mm.

B. Cutout

The bezel must provide a cutout that allows proper mounting of the connector assembly. With Type 1, the EMI gasket grounding feature must be compressed by the bezel in order to provide an electrical ground between the connector assembly and bezel for EMI suppression. With Type 2, the EMI compressions springs must be through the bezel. Care must be used to avoid interference between adjacent connector assemblies and other components. The minimum allowable distance between connector assemblies must be considered to ensure proper assembly. Dimensions for bezel cutout and minimum allowable distance between cutouts are shown in Figure 4.

3.9. PC Board and Bezel Position

The bezel and pc board must be positioned in relation to each other to avoid interference with the function of the housing assembly module locking latch and to ensure proper function of the panel ground springs. This relationship must conform to the dimensions stated in Figure 4.

Type 1

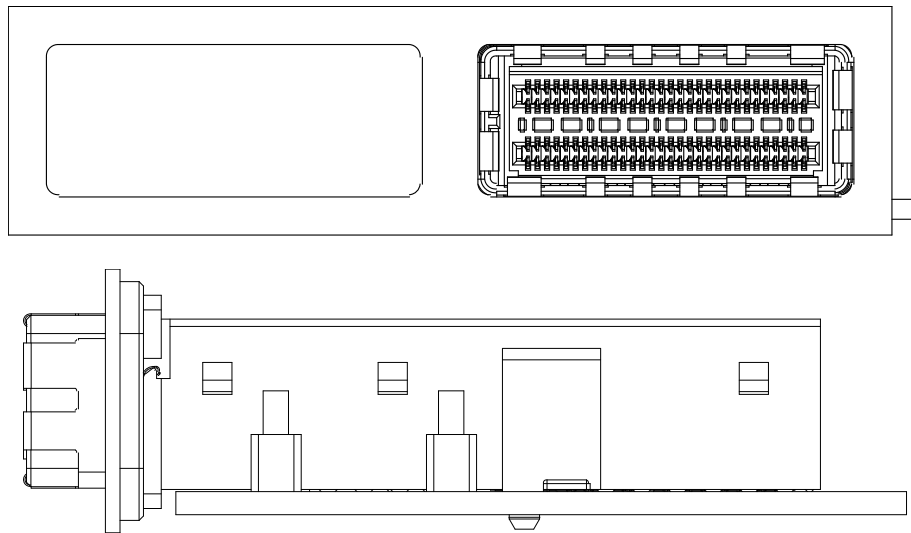

Type 2

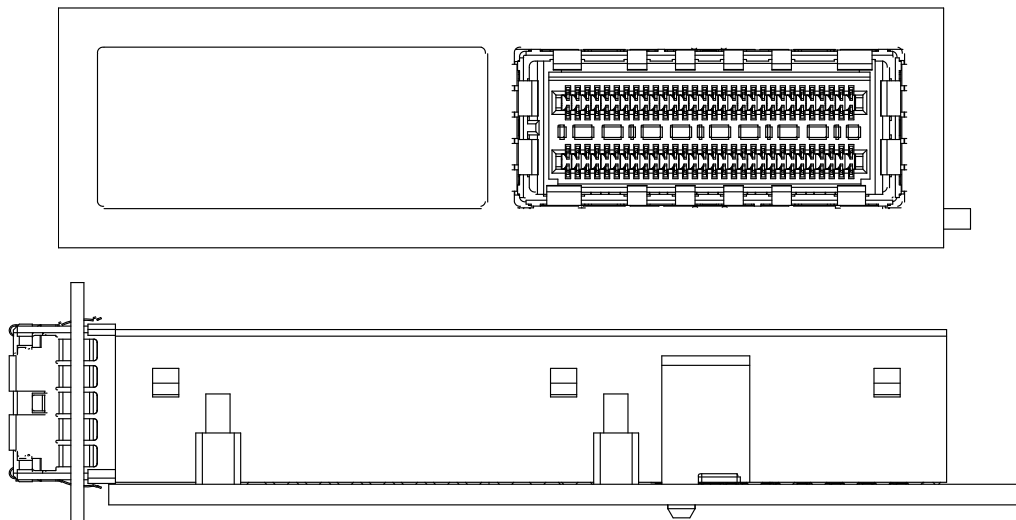

Figure 4

3.10. Placement

The following requirements also apply to connectors assemblies used for rework purposes.



CAUTION

To avoid damage to elastomeric gasket, panel ground springs, and compliant tails, handle only by sides.

A. Registration

The compliant pin contacts and mounting posts must be aligned with matching holes in the pc board, then inserted into the pc board simultaneously to prevent twisting or bending of the compliant pin contacts.

B. Seating

Using proper seating force and seating height is essential to interconnection performance. The force used to seat the connector assembly must be applied evenly to prevent deformation or other damage to the compliant pin contacts. The force required to seat the connector assembly onto the pc board is 24.5 N [5.5 lbf] per contact.



CAUTION

Over-driving of the connector and housing assembly will deform parts critical to the quality of the connection. Maximum force occurs prior to the connector assembly bottoming on the pc board.

The shut height of the application tool must be specifically set for proper seating of the connector and housing assembly. The shut height can be calculated by:

$$\text{Seating Height (Connector and Housing Assembly Seated)} + \text{Height of Seating Tool} + \text{Combined Thicknesses of PC Board and PC Board Support Fixture} = \text{Shut Height (Ram Down)}$$

The seating height, measured from the top of the housing assembly (not including the panel grounding feature) to the top of the pc board, is given in Figure 5. The connector assembly must be seated on the pc board not exceeding the dimensions shown in Figure 5.



NOTE

The shut height may need to be adjusted to obtain the 0.10 mm maximum gap between the standoffs of the housing assembly and the pc board.

3.11. Checking Assembly

After assembly, the cage assembly panel grounding feature must be compressed by the bezel. A slight bow in the cage assembly is permitted. The bezel and pc board must be positioned according to the dimensions shown in Figure 5.

Type 1

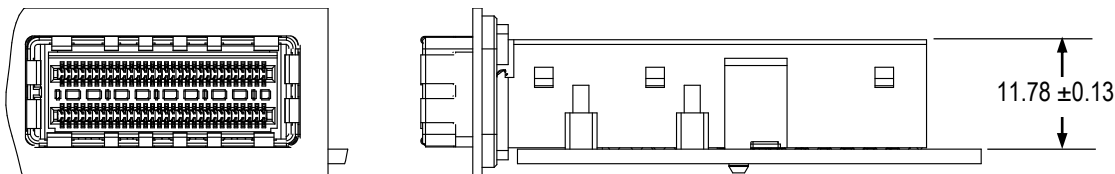

Type 2

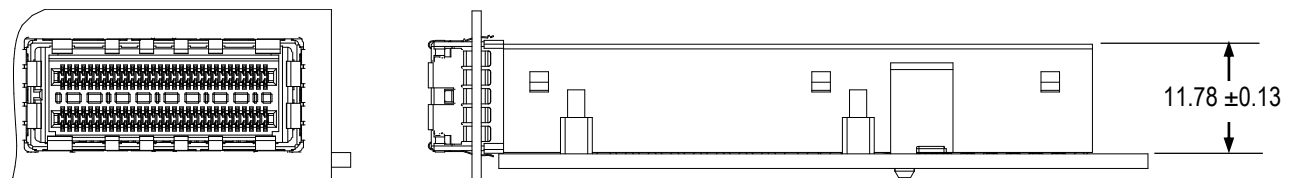

Figure 5

3.12. Repair and Rework

Damaged or defective connector and housing assemblies must be removed and replaced. If repair or rework to the pc board requires soldering after the connector assembly has been seated onto the pc board, the following must apply:

- After soldering, removal of fluxes, residues, and activators is necessary. Consult with the supplier of the solder and flux for recommended cleaning solvents. Cleaners must be free of dissolved flux and other contaminants. Even when using a “no clean” solder paste, it is imperative that the contact interface be kept clean of flux and residue (since it acts as an insulator).



DANGER

Consideration must be given to toxicity and other safety requirements recommended by the solvent manufacturer. Refer to the manufacturer's Material Safety Data Sheet (MSDS) for characteristics and handling of cleaners. Trichloroethylene and Methylene Chloride is not recommended because of harmful occupational and environmental effects. Both are carcinogenic (cancer-causing).

- Air drying is recommended. Otherwise, make sure that temperature limitations are not exceeded: -40° to 85°C [-40° to 185°F]. Excessive temperatures may cause housing degradation.

4. QUALIFICATION

CDFP connectors have not yet been sent for agency evaluation and testing.

5. TOOLING

5.1. Seating Tool Kits

The seating tool kits are used to seat the connector and housing assembly onto the pc board. See Figure 6.

5.2. Extraction Tool

The extraction tool is used to remove the connector assembly from the pc board by pushing the pc board off of the connector assembly. The part should not be reused.

5.3. Application Tool

Power for the seating tools and extraction tools must be provided by an application tool (with a ram) capable of supplying a downward force of 24.5 N [5.5 lbf] per contact. For available application tools, call Product Information at the number at the bottom of page 1.

5.4. PC Board Support Fixture

A pc board support must be used with the seating tool and the extraction tool. The support fixture provides proper support for the pc board and protects the pc board and the connector and housing assembly from damage. The support fixture must be customer designed. It is recommended that the support fixture be at least 25.4 mm longer and wider than the pc board and have flat surfaces with holes or a channel large enough and deep enough to receive any protruding components of the connector assembly.

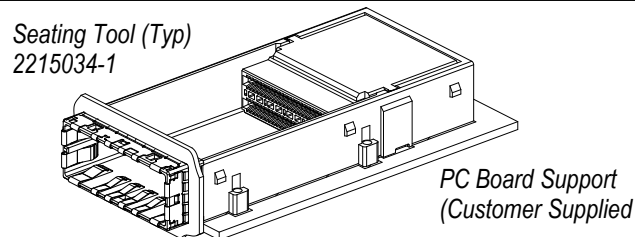

CDFP CONNECTOR	EXTRACTION TOOL	INSERTION TOOL
Type 1	2215033-1	2215034-1
Type 2	2215033-2	
Both Type 1 & Type 2	2215033-3	

Figure 6

6. VISUAL AID

The illustration below shows a typical application of this product. This illustration should be used by production personnel to ensure a correctly applied product. Applications which do not appear correct should be inspected using the information in the preceding pages of this specification and in the instructional material shipped with the product or tooling.

TYPE 1 ASSEMBLY

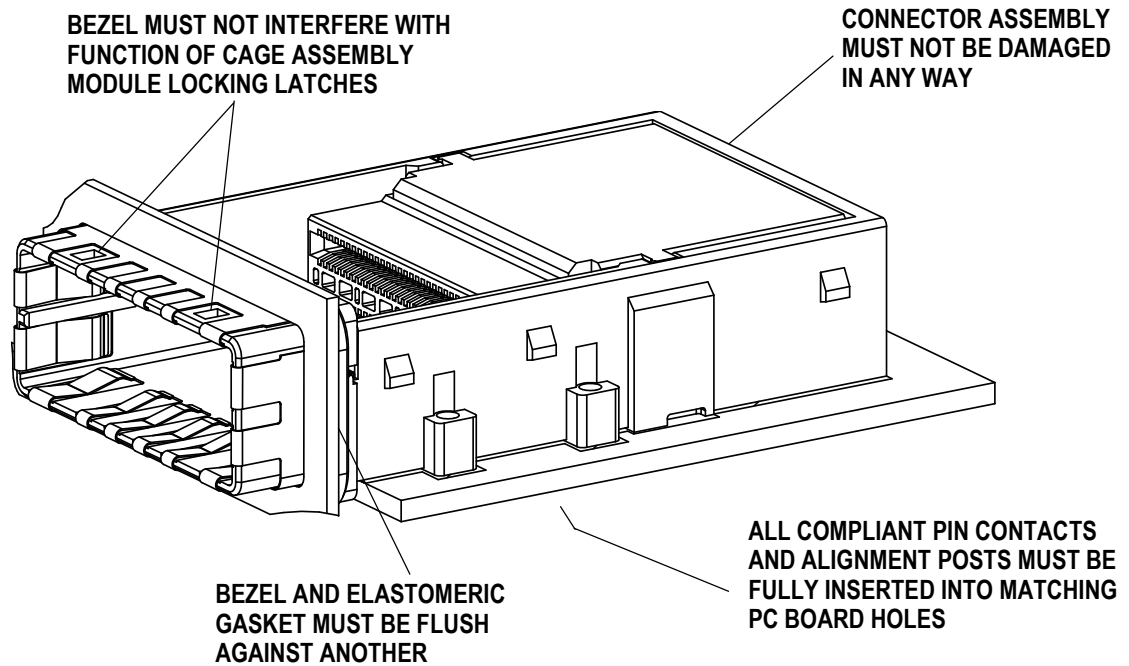

TYPE 2 ASSEMBLY

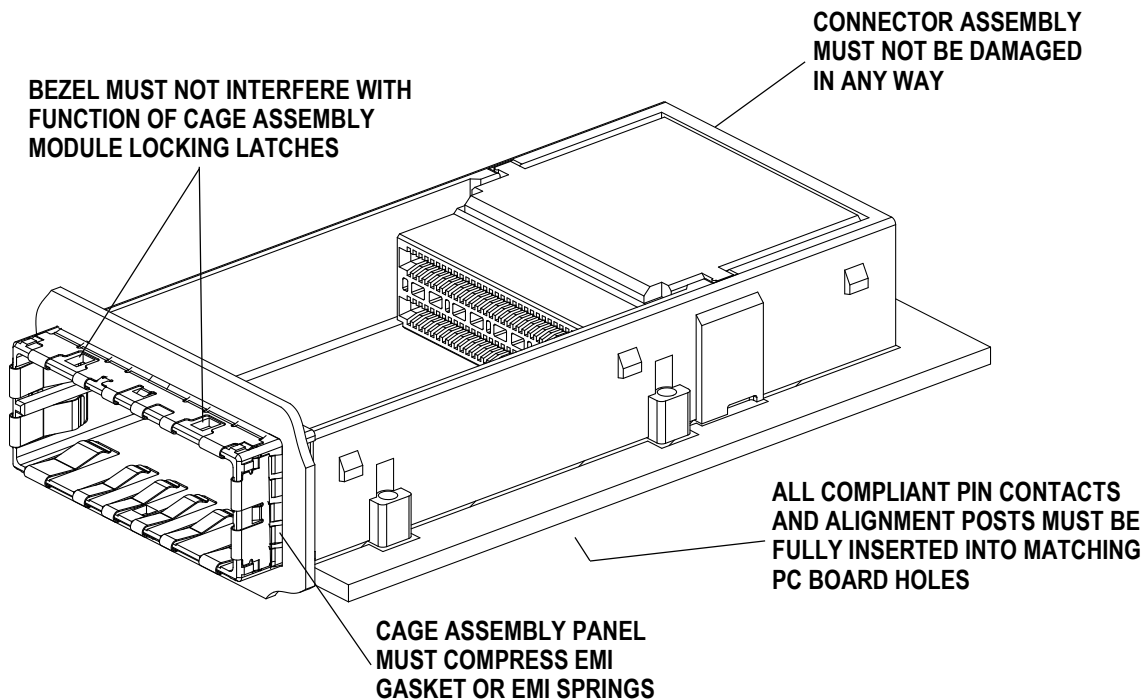

FIGURE 7. VISUAL AID