

ANT-868-CW-QW

Data Sheet

Product Description

CW Series ¼-wave antennas deliver outstanding performance in a rugged and cosmetically attractive package. These antennas are available with standard SMA or FCC Part 15 compliant RP-SMA connectors. RP-SMA connectors allow for easy field replacement while complying with FCC requirements. A wide variety of matching connectors permit numerous mounting options.

Features

- Low cost
- Excellent performance
- Omni-directional pattern
- Wide bandwidth
- Very low VSWR
- Fully weatherized
- Flexible main shaft
- Rugged & damage-resistant
- SMA or Part 15 compliant RP-SMA connector
- Use with plastic* or metal enclosures

*Requires proximity ground plane

Electrical Specifications

Center Frequency:	868MHz
Recom. Freq. Range:	750–950MHz
Wavelength:	¼-wave
Peak Gain:	1.6dBi
VSWR:	<1.9 typ. at center
Impedance:	50-ohms
Connector:	RP-SMA or SMA
Oper. Temp. Range:	–40°C to +90°C

Electrical specifications and plots measured on 10.16 cm x 10.16 cm (4.00" x 4.00") reference ground plane

Ordering Information

ANT-868-CW-QW (with RP-SMA connector)
ANT-868-CW-QW-SMA (with SMA connector)

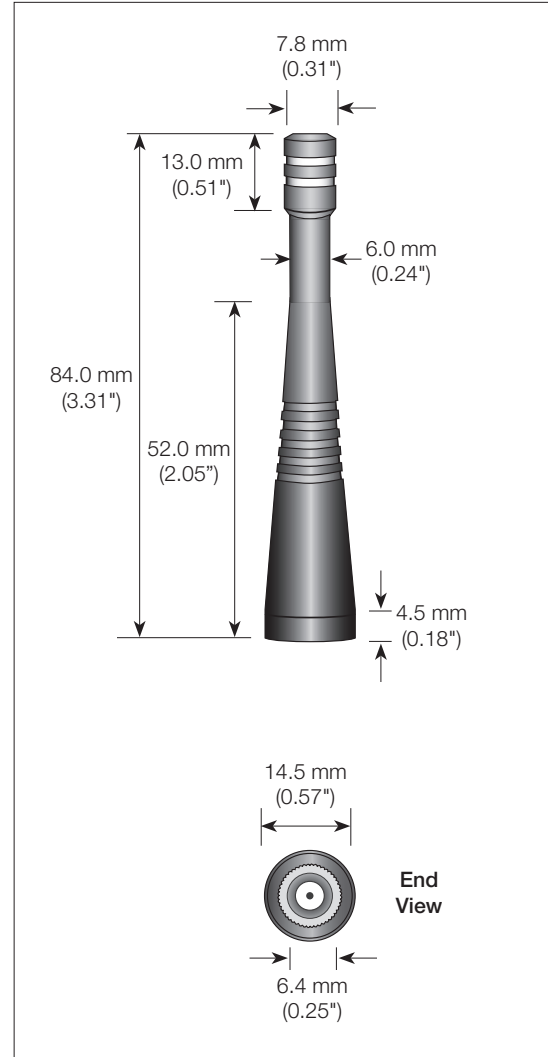

Counterpoise

Quarter-wave or monopole antennas require an associated ground plane counterpoise for proper operation. The size and location of the ground plane relative to the antenna will affect the overall performance of the antenna in the final design. When used in conjunction with a ground plane smaller than that used to tune the antenna, the center frequency typically will shift higher in frequency and the bandwidth will decrease. The proximity of other circuit elements and packaging near the antenna will also affect the final performance. For further discussion and guidance on the importance of the ground plane counterpoise, please refer to Linx Application Note AN-00501: Understanding Antenna Specifications and Operation.

VSWR Graph

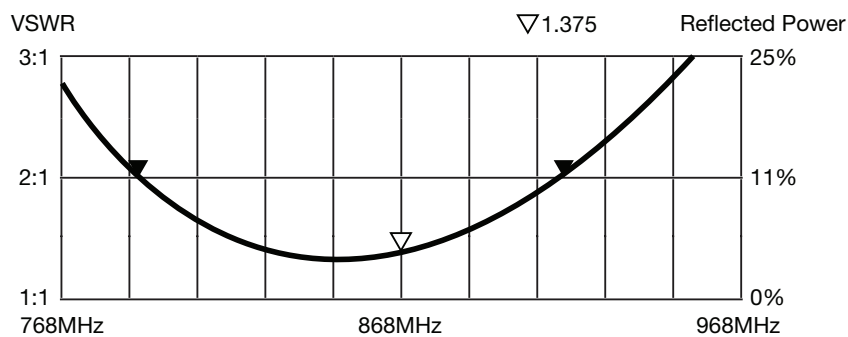

What is VSWR?

The Voltage Standing Wave Ratio (VSWR) is a measurement of how well an antenna is matched to a source impedance, typically 50-ohms. It is calculated by measuring the voltage wave that is headed toward the load versus the voltage wave that is reflected back from the load. A perfect match will have a VSWR of 1:1. The higher the first number, the worse the match, and the more inefficient the system. Since a perfect match cannot ever be obtained, some benchmark for performance needs to be set. In the case of antenna VSWR, this is usually 2:1. At this point, 88.9% of the energy sent to the antenna by the transmitter is radiated into free space and 11.1% is either reflected back into the source or lost as heat on the structure of the antenna. In the other direction, 88.9% of the energy recovered by the antenna is transferred into the receiver. As a side note, since the “:1” is always implied, many data sheets will remove it and just display the first number.

How to Read a VSWR Graph

VSWR is usually displayed graphically versus frequency. The lowest point on the graph is the antenna’s operational center frequency. In most cases, this will be different than the designed center frequency due to fabrication tolerances. The VSWR at that point denotes how close to 50-ohms the antenna gets. Linx specifies the recommended bandwidth as the range where the typical antenna VSWR is less than 2:1.

TE TECHNICAL SUPPORT CENTER

USA:	+1 (800) 522-6752
Canada:	+1 (905) 475-6222
Mexico:	+52 (0) 55-1106-0800
Latin/S. America:	+54 (0) 11-4733-2200
Germany:	+49 (0) 6251-133-1999
UK:	+44 (0) 800-267666
France:	+33 (0) 1-3420-8686
Netherlands:	+31 (0) 73-6246-999
China:	+86 (0) 400-820-6015

te.com

TE Connectivity, TE, TE connectivity (logo), Linx and Linx Technologies are trademarks owned or licensed by the TE Connectivity Ltd. family of companies. All other logos, products and/or company names referred to herein might be trademarks of their respective owners.

The information given herein, including drawings, illustrations and schematics which are intended for illustration purposes only, is believed to be reliable. However, TE Connectivity makes no warranties as to its accuracy or completeness and disclaims any liability in connection with its use. TE Connectivity's obligations shall only be as set forth in TE Connectivity's Standard Terms and Conditions of Sale for this product and in no case will TE Connectivity be liable for any incidental, indirect or consequential damages arising out of the sale, resale, use or misuse of the product. Users of TE Connectivity products should make their own evaluation to determine the suitability of each such product for the specific application.

TE Connectivity warrants to the original end user customer of its products that its products are free from defects in material and workmanship. Subject to conditions and limitations TE Connectivity will, at its option, either repair or replace any part of its products that prove defective because of improper workmanship or materials. This limited warranty is in force for the useful lifetime of the original end product into which the TE Connectivity product is installed. Useful lifetime of the original end product may vary but is not warranted to exceed one (1) year from the original date of the end product purchase.

©2023 TE Connectivity. All Rights Reserved.

04/23 Original