



HCR6927M3

LTE Rotatable Shell Omni-directional Antenna 698-960 MHz/1710-2700 MHz

This Laird LTE rotatable shell omni-directional antenna is a tough low-profile antenna for outdoor or indoor applications. This antenna provides frequency agility, low visibility, wide bandwidth and a low angle radiation pattern that is superior to traditional gain antennas in most applications.

The HCR6927M antenna is available in various industry-standard mounting configurations including a threaded permanent stud mount model for vandal resistant mounting on brackets, panels, ceilings, or any other kind of housing.

FEATURES AND BENEFITS

- Multi-band operation: 698-960 MHz/1710-2700 MHz
- Meets IP67 protection rating for dust tight seal and temporary water immersion
- Permanent mount provides vandal resistant protection for remote installations
- Conformance to RoHS
- Includes DC Short for ESD Protection

ELECTRICAL SPECIFICATIONS

Operating Frequency (MHz)	698-960	1710-2700
Gain - Max (dBi)	1.3	2.8
VSWR	<2:1	
Nominal Impedance (Ohms)	50	
Max Power - Ambient 25°C (W)	10	
Polarization	Vertical	

MECHANICAL SPECIFICATIONS

Dimensions - height x diameter - mm (inches)	83.3 x 36.5 (3.47 x 1.4)
Weight - g (lbs.)	NMO - 106 (0.23) P-Mount - 192.5 (0.42)
Antenna Color	Black/White

ENVIRONMENTAL SPECIFICATIONS

Operating Environment (Indoor or Outdoor)	Indoor and outdoor
Operating Temperature - °C (°F)	-30 to +70°C (-22 to +158°F)
Storage Temperature - °C (°F)	-40 to +85°C (-40 to +185°F)
Wind Survival - km/hr (mph)	282 (175)
Ingress Protection Rating	IP67
Material Substance Compliance	RoHS

CONFIGURATION

PART NUMBER	FREQUENCY	COLOR	MOUNT
HCR6927M3NBL-001	698-960 MHz	Black - w/ logo	NMO
HCR6927M3NWL-001	698-960 MHz	White - w/ logo	NMO
HCR6927M3NBN-001	698-960 MHz	Black - w/ logo	NMO
HCR6927M3NWN-001	698-960 MHz	White - w/ logo	NMO
HCR6927M3PBL-001	1710-2700 MHz	Black - w/ logo	P-mount
HCR6927M3PWL-001	1710-2700 MHz	White - w/ logo	P-mount
HCR6927M3PBN-001	1710-2700 MHz	Black - w/ logo	P-mount
HCR6927M3PWN-001	1710-2700 MHz	White - w/ logo	P-mount

MOUNTING OPTIONS

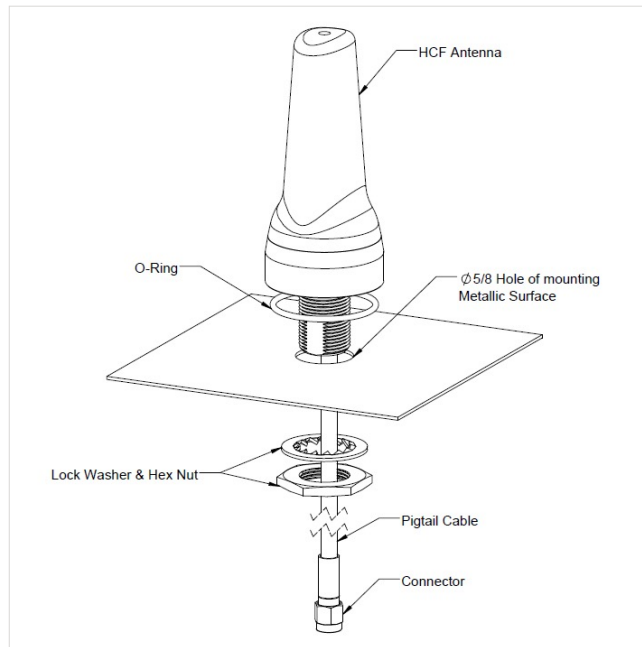

RADIATION PATTERNS

698 MHz

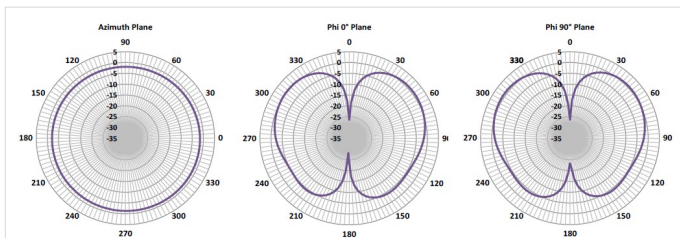

824 MHz

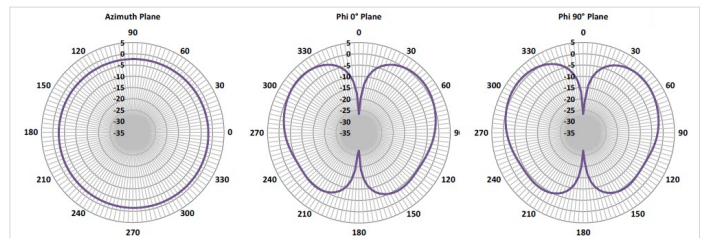

915 MHz

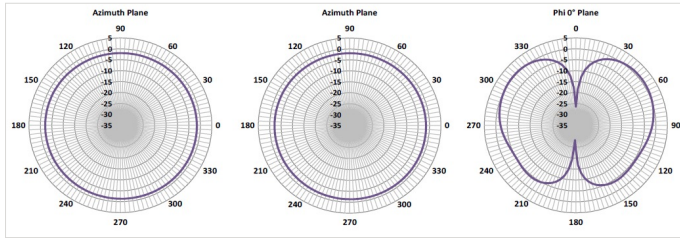

960 MHz

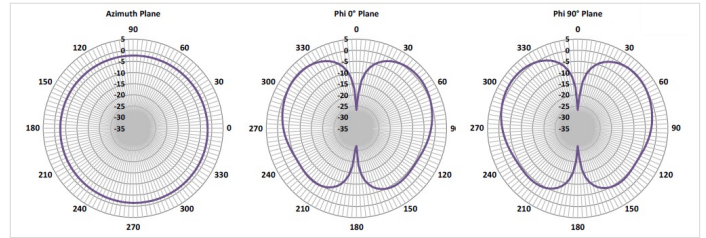

1710 MHz

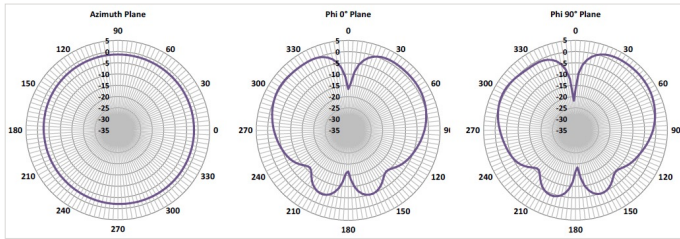

1950 MHz

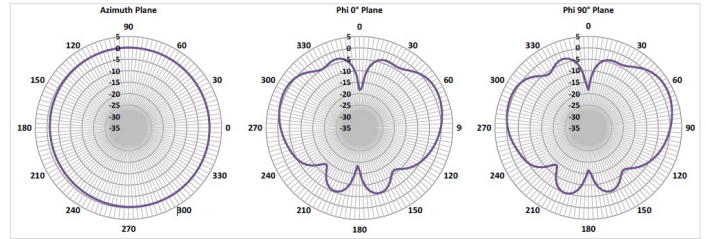

2440 MHz

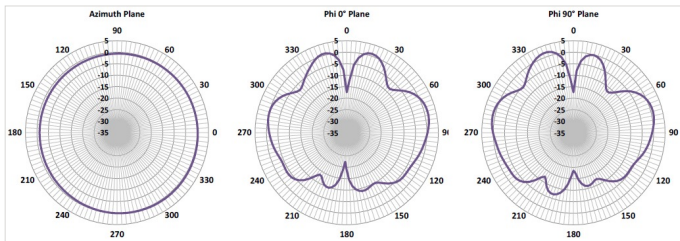

2700 MHz

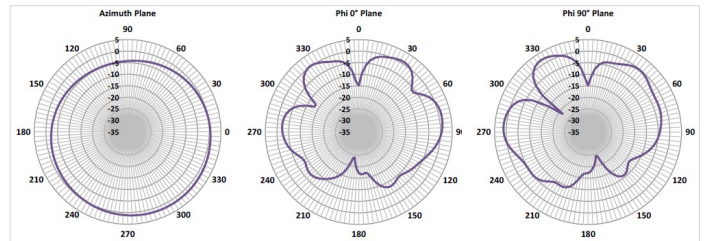

TE TECHNICAL SUPPORT CENTER

USA:	+1 (800) 522-6752
Canada:	+1 (905) 475-6222
Mexico:	+52 (0) 55-1106-0800
Latin/S. America:	+54 (0) 11-4733-2200
Germany:	+49 (0) 6251-133-1999
UK:	+44 (0) 800-267666
France:	+33 (0) 1-3420-8686
Netherlands:	+31 (0) 73-6246-999
China:	+86 (0) 400-820-6015

te.com

TE Connectivity, TE Connectivity (logo) and Every Connection Counts are trademarks. All other logos, products and/or company names referred to herein might be trademarks of their respective owners.

The information given herein, including drawings, illustrations and schematics which are intended for illustration purposes only, is believed to be reliable.

However, TE Connectivity makes no warranties as to its accuracy or completeness and disclaims any liability in connection with its use. TE Connectivity's obligations shall only be as set forth in TE Connectivity's Standard Terms and Conditions of Sale for this product and in no case will TE Connectivity be liable for any incidental, indirect or consequential damages arising out of the sale, resale, use or misuse of the product. Users of TE Connectivity products should make their own evaluation to determine the suitability of each such product for the specific application.

TE warrants to the original end user customer of its products that its products are free from defects in material and workmanship. Subject to conditions and limitations TE will, at its option, either repair or replace any part of its products that prove defective because of improper workmanship or materials. This limited warranty is in force for the useful lifetime of the original end product into which the TE product is installed. Useful lifetime of the original end product may vary but is not to exceed five (5) years from the original date of the end product purchase.

©2021 TE Connectivity. All Rights Reserved.

11/21 Original

