

ANT-LTE-MON-SMA

Data Sheet

Product Description

The Linx MON Series LTE antenna is a high-end design that provides excellent performance in a tiny package. It offers higher efficiency at the lower frequency bands on a smaller ground plane than competitive products. This equates to better range in a smaller product size, saving valuable real estate in the design. The tilt and swivel joint design allows for the antenna to be positioned for optimum performance in the product or folded against the enclosure for shipping or transport. This durable and versatile design also reduces any damage from impact force compared to a fixed design.

This combination of high performance and small size makes the MON Series ideal for small devices, particularly when used for the Internet of Things (IoT) and with the CAT-M1 and NB-IOT standards. Also covering all major bands used by LTE, 3G and 4G cellular technologies, the MON Series is backed by the thorough testing and validation and rigorous quality control that Linx is known for.



Features

- Covers all common 4G/3G/2G and LTE bands
- Tilt / Swivel Joint for optimum positioning
- Small, unobtrusive profile

Ordering Information

ANT-LTE-MON-SMA

Electrical Specifications

Electrical Specifications						
Parameter	LTE/ GSM850/ GSM900	DCS/ PCS/ UMTS1	LTE 2300	LTE 2600	LTE3500	LTE3700
Recommended Frequency Range	698 – 960	1710 – 2170	2300 – 2400	2500 – 2700	3400 – 3600	3600 – 3800
VSWR (typical at center)	<2.5:1	<3.5:1	<4.6:1	<3.7:1	<2.2:1	<2.8:1
Peak Gain (max in the band)	5.8dBi	3.7dBi	2.0dBi	1.4dBi	5.2dBi	6.1dBi
Average Gain (typical)	-0.50dBi	-1.75dBi	-2.90dBi	-3.05dBi	-1.95dBi	-2.20dBi
Efficiency (typical)	82%	70%	52%	60%	65%	60%
Polarization	Linear					
Radiation	Omni-Directional					
Max Power	15W					
Wavelength	¼-wave					
Impedance	50-ohms					
Connection	SMA Plug (Male)					
Weight	8g (0.3oz.)					
Operating Temperature Range	-40°C to +70°C					

Measurements taken on a 100 x 100mm (4 x 4in) ground plane, mounted on the edge, straight

Dimensions

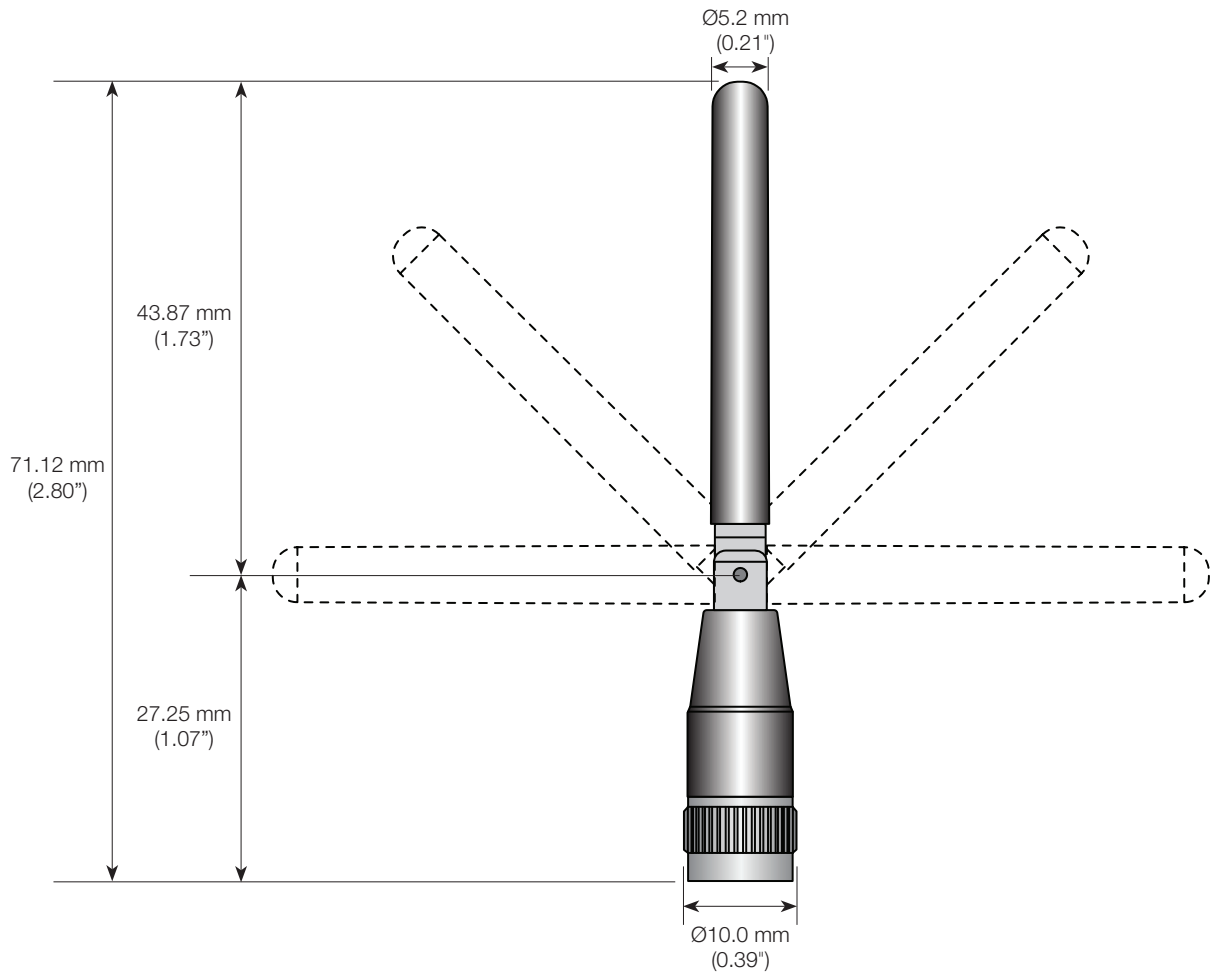

Edge of the Ground Plane, Straight



VSWR

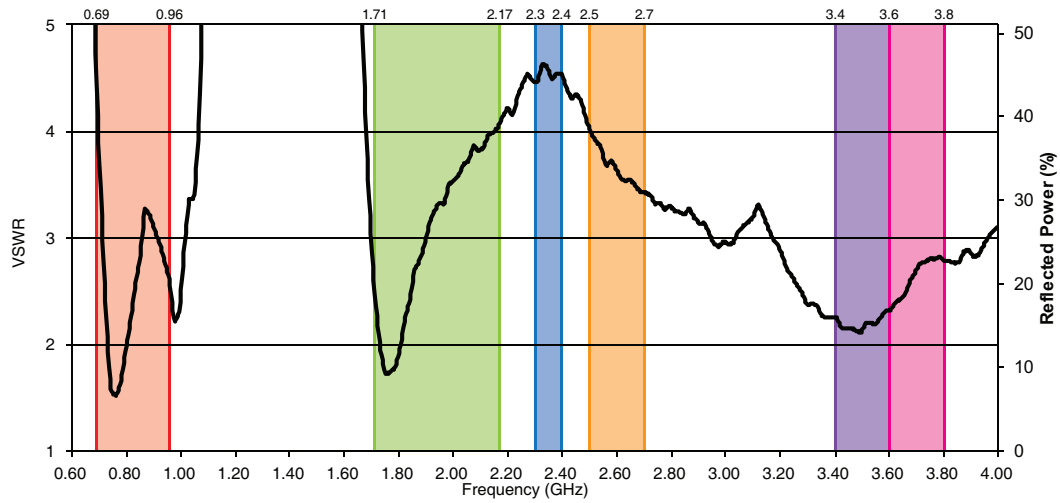

Return Loss

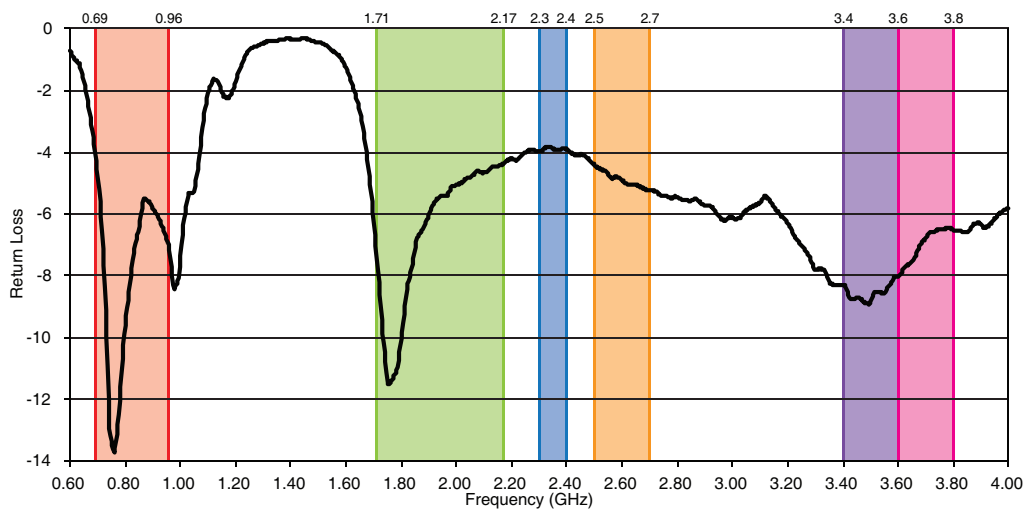

Peak Gain

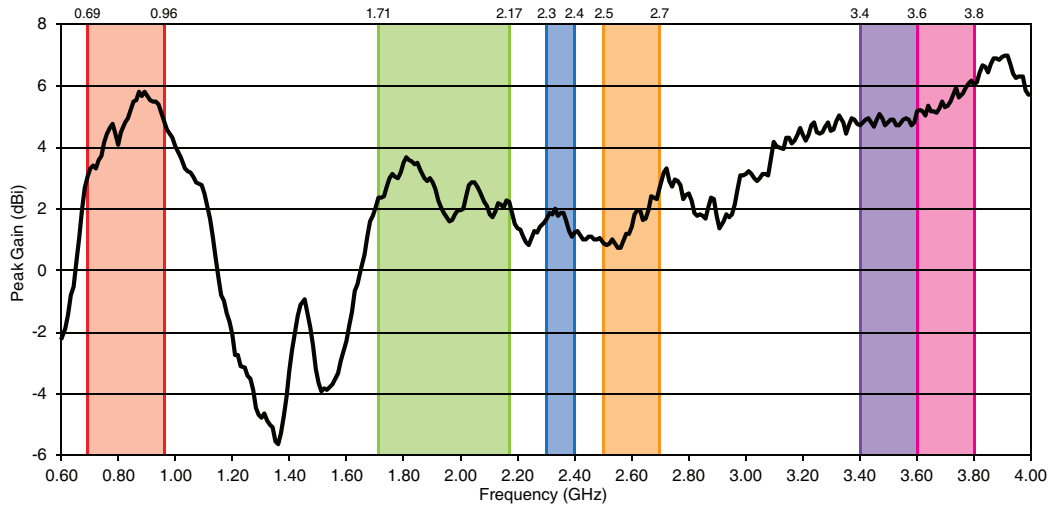

Average Gain

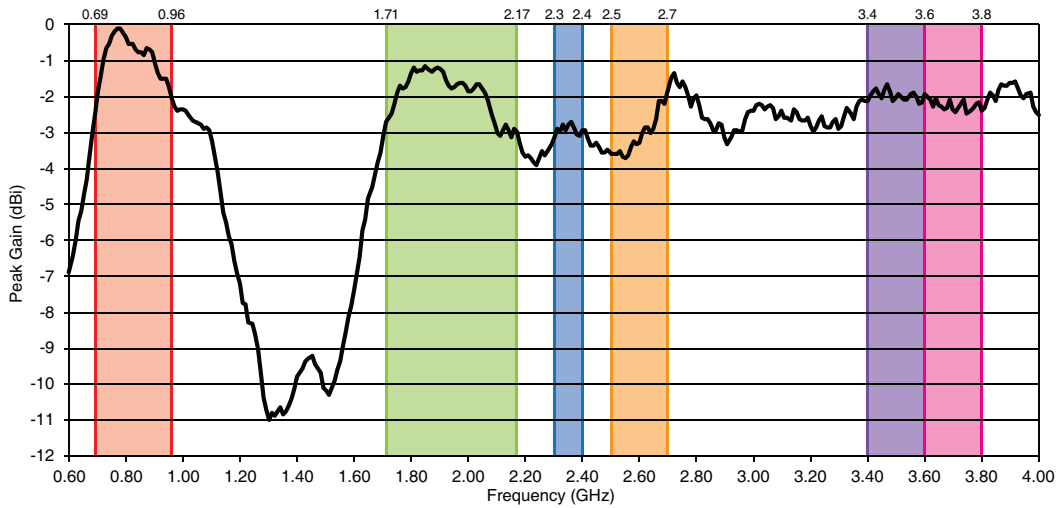

Radiation Efficiency

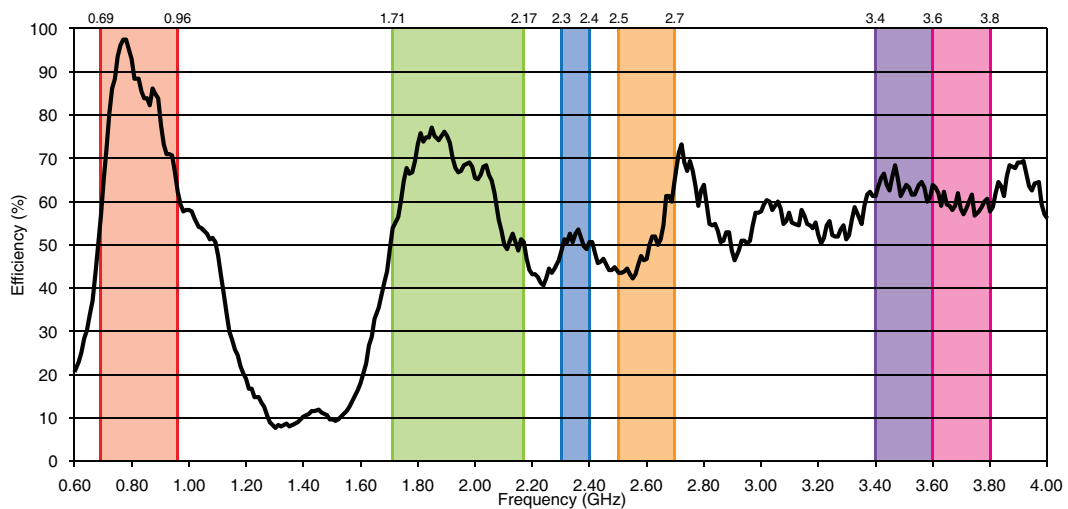

Gain Plots - Edge of Plane, Straight

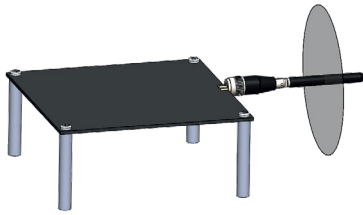

XZ-Plane Gain

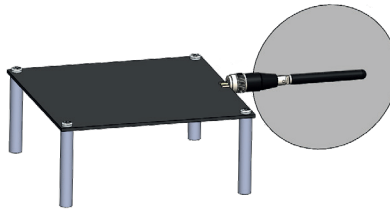

YZ-Plane Gain

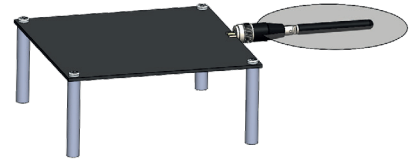

XY-Plane Gain

700 - 960MHz

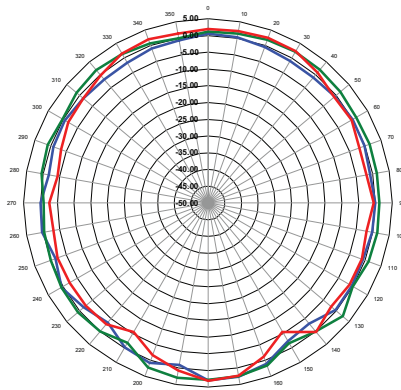

XZ-Plane Gain

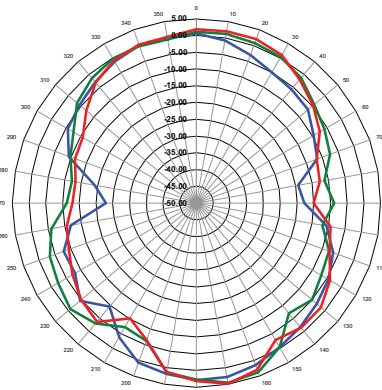

YZ-Plane Gain

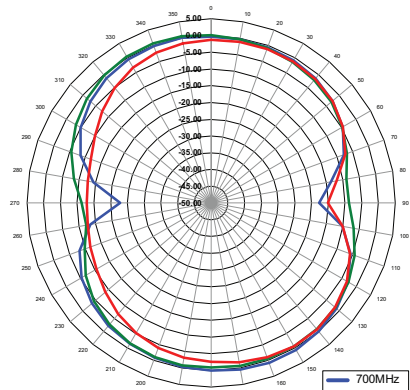

XY-Plane Gain



1710 - 2170MHz

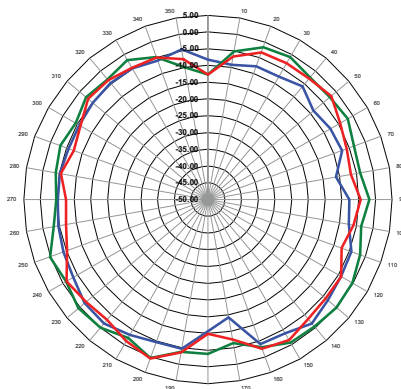

XZ-Plane Gain

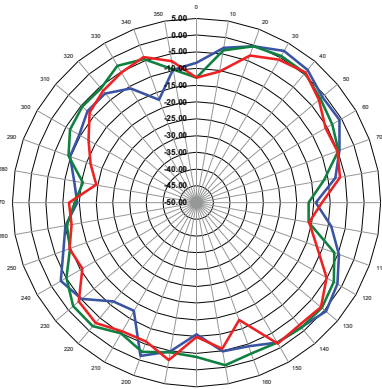

YZ-Plane Gain

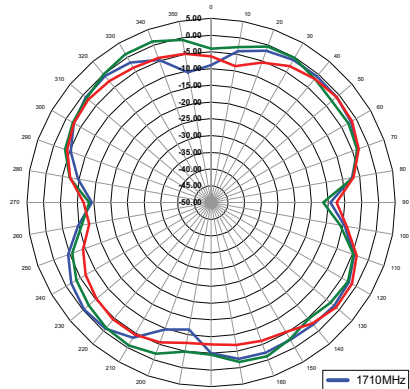

XY-Plane Gain



Gain Plots - Edge of Plane, Straight

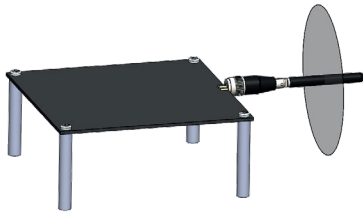

XZ-Plane Gain

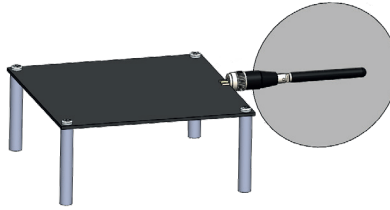

YZ-Plane Gain

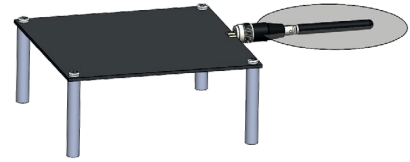

XY-Plane Gain

2300 - 2400MHz

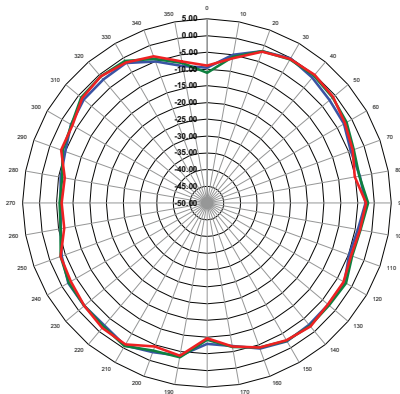

XZ-Plane Gain

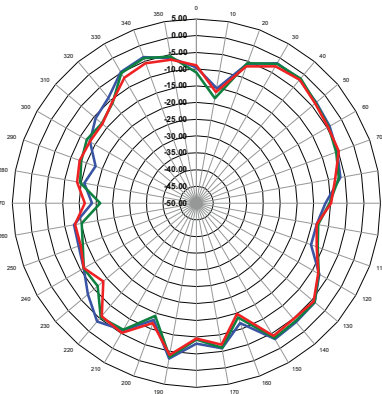

YZ-Plane Gain

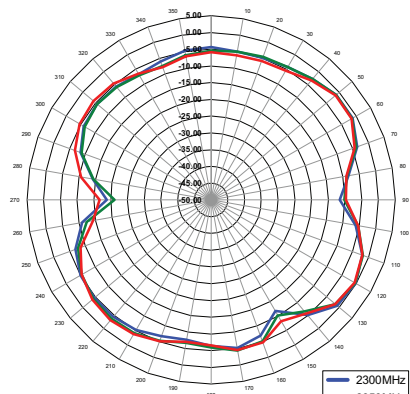

XY-Plane Gain



2500 - 2700MHz

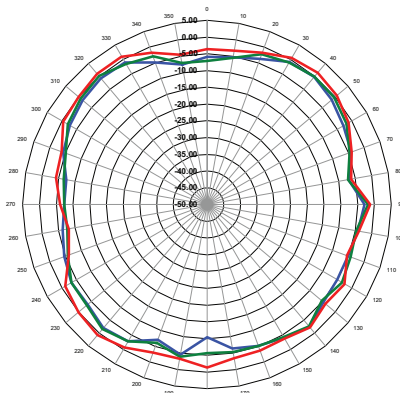

XZ-Plane Gain

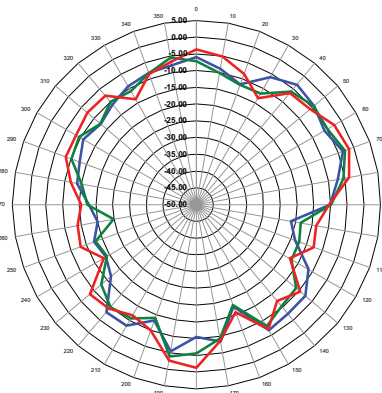

YZ-Plane Gain

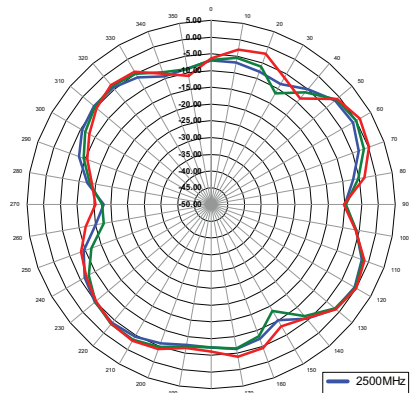

XY-Plane Gain



Gain Plots - Edge of Plane, Straight

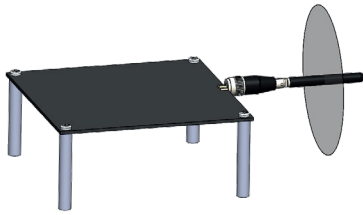

XZ-Plane Gain

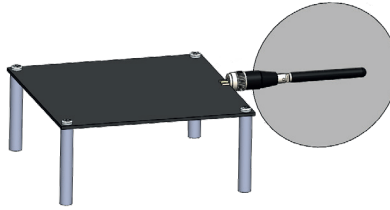

YZ-Plane Gain

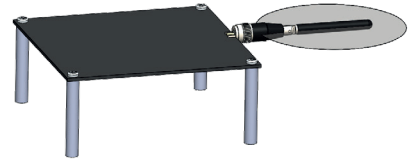

XY-Plane Gain

3400 - 3600MHz

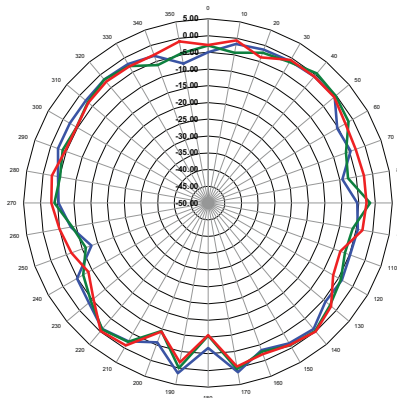

XZ-Plane Gain

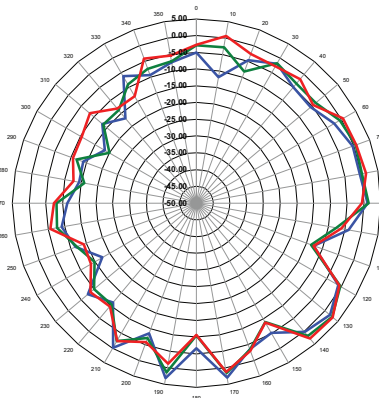

YZ-Plane Gain

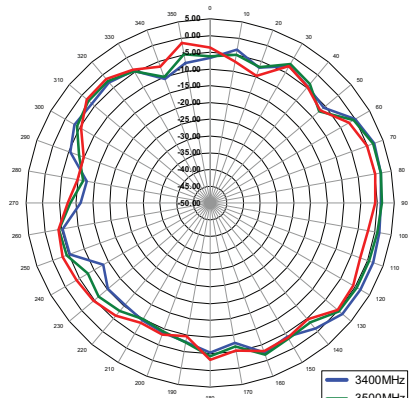

XY-Plane Gain



3600 - 3800MHz

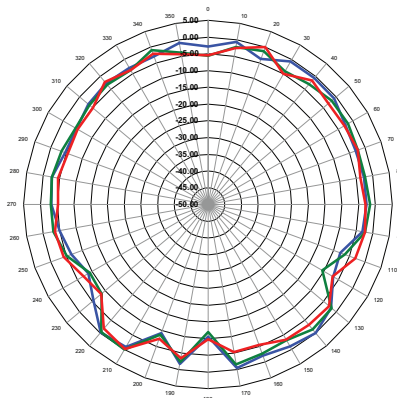

XZ-Plane Gain

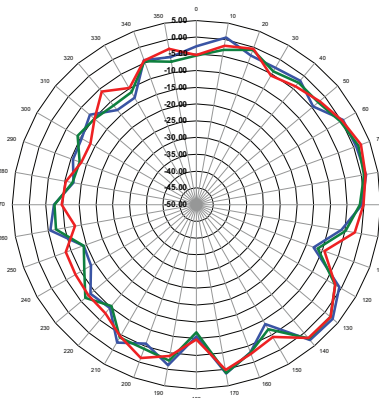

YZ-Plane Gain

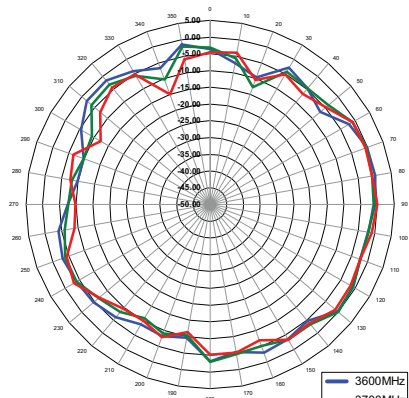

XY-Plane Gain



Edge of the Ground Plane, Bent 90°



VSWR

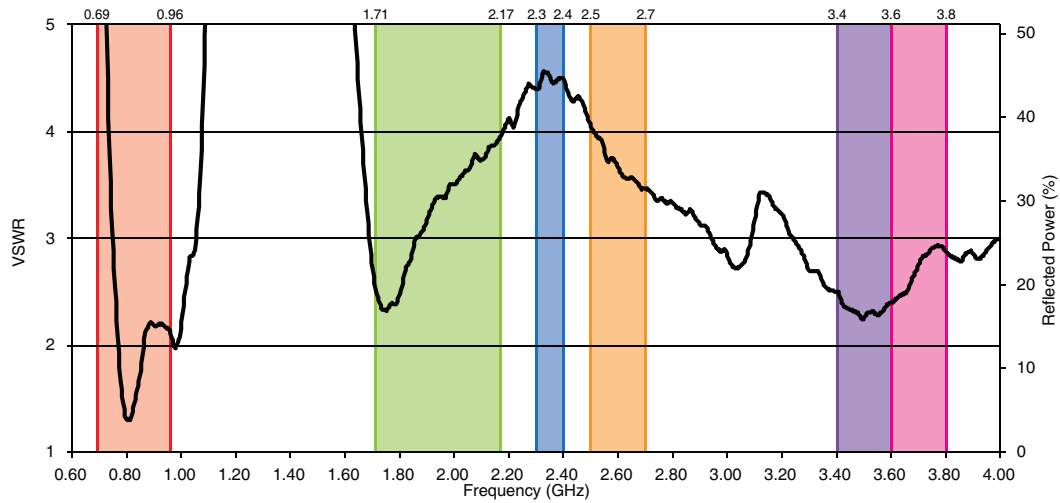

Return Loss

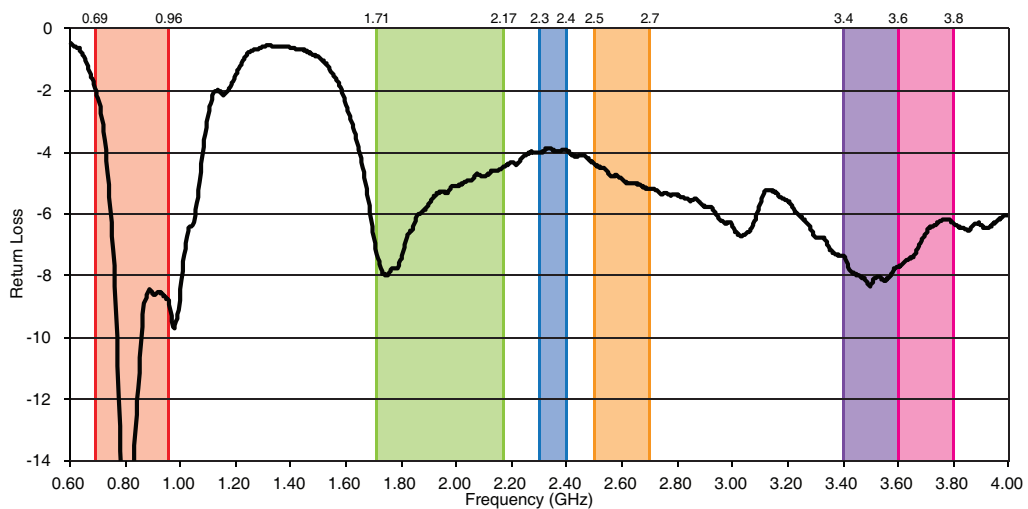

Peak Gain

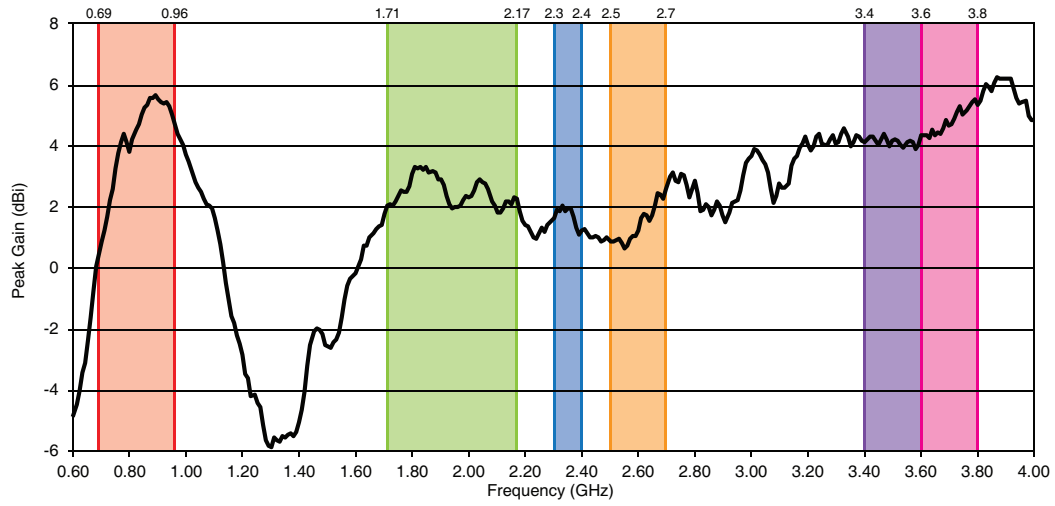

Average Gain

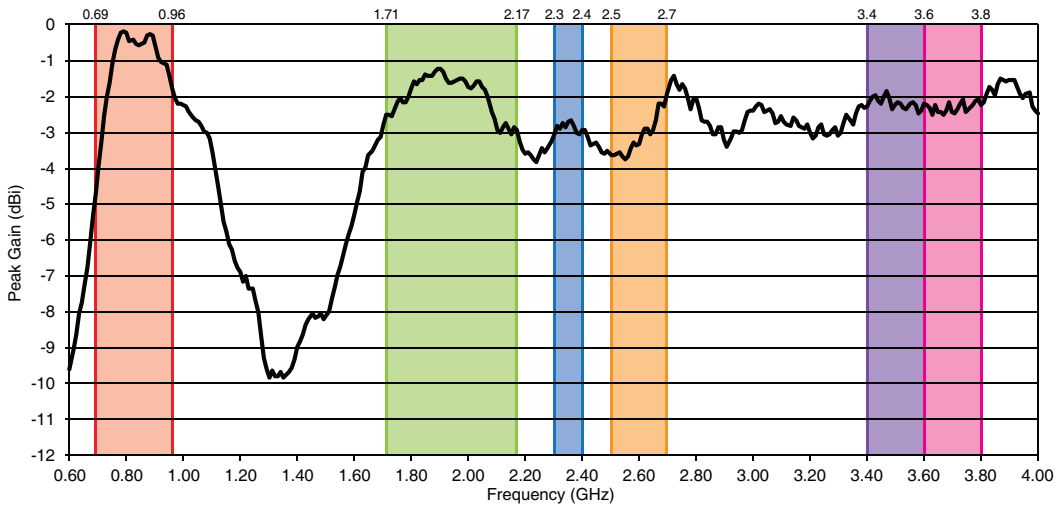

Radiation Efficiency

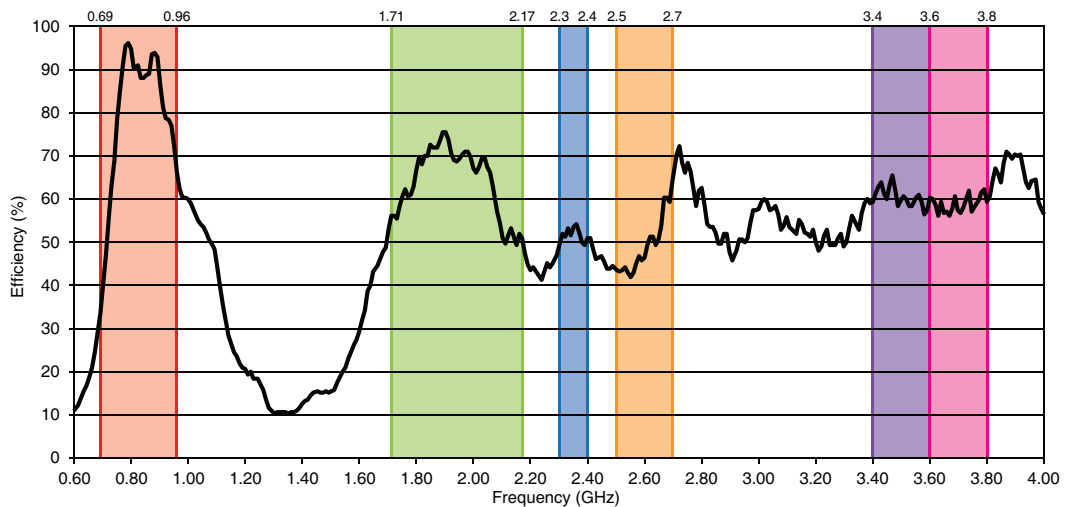

Gain Plots - Edge of Plane, Bent 90°

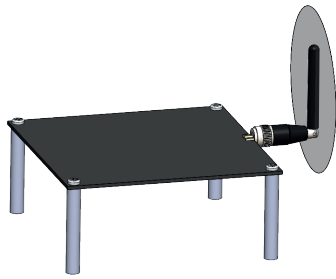

XZ-Plane Gain

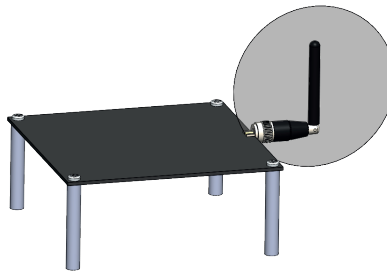

YZ-Plane Gain

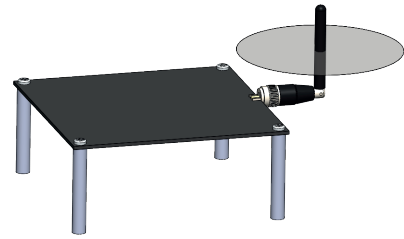

XY-Plane Gain

700 - 960MHz

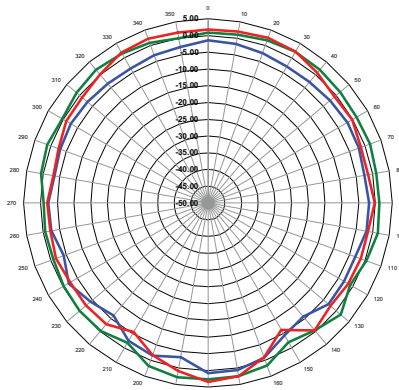

XZ-Plane Gain

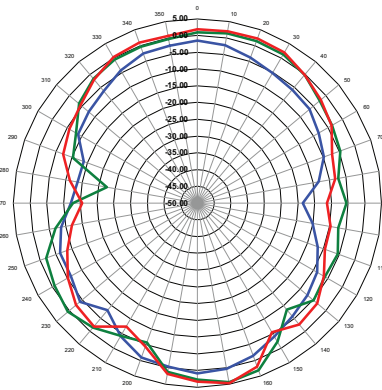

YZ-Plane Gain

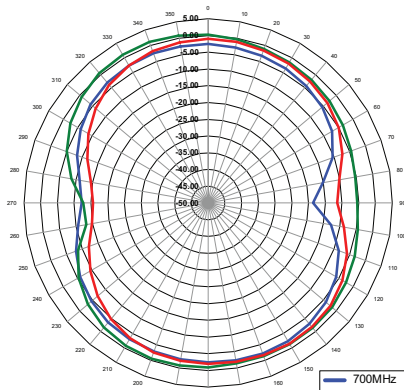

XY-Plane Gain



1710 - 2170MHz

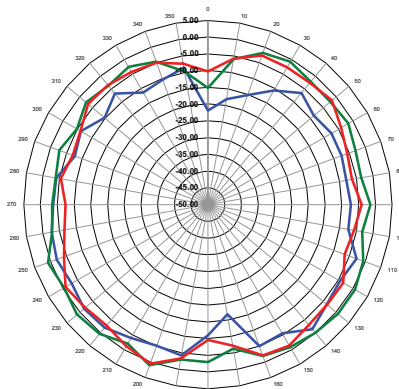

XZ-Plane Gain

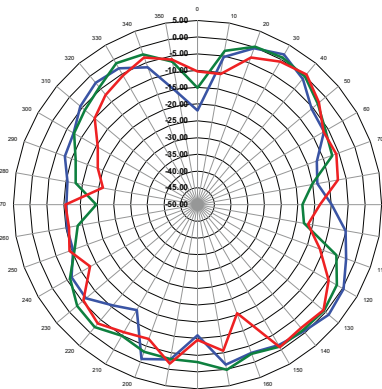

YZ-Plane Gain

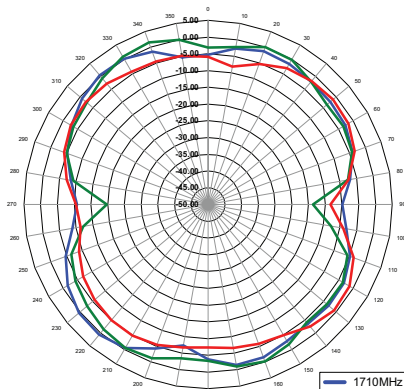

XY-Plane Gain



Gain Plots - Edge of Plane, Bent 90°

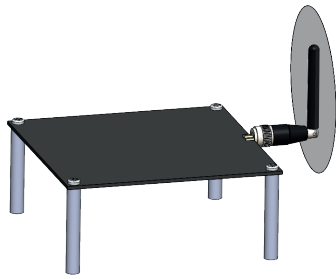

XZ-Plane Gain

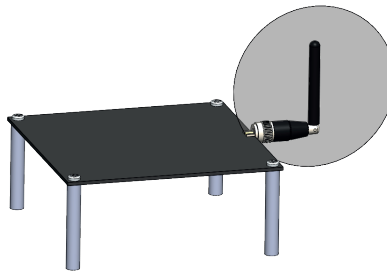

YZ-Plane Gain

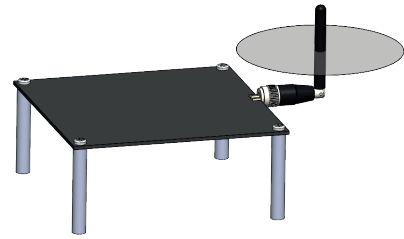

XY-Plane Gain

2300 - 2400MHz

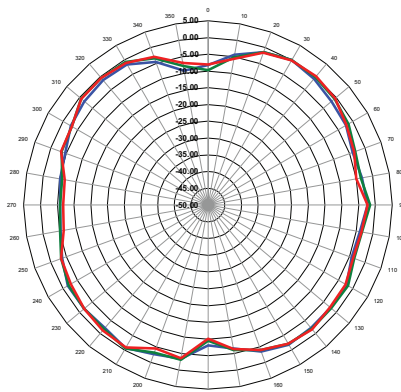

XZ-Plane Gain

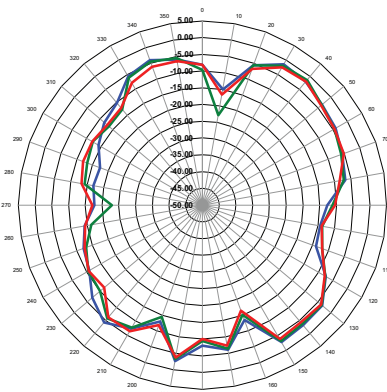

YZ-Plane Gain

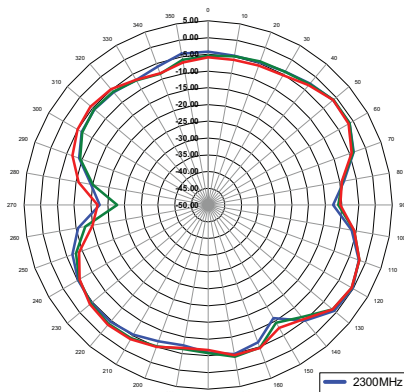

XY-Plane Gain



2500 - 2700MHz

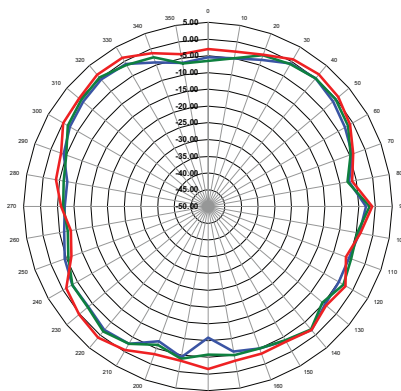

XZ-Plane Gain

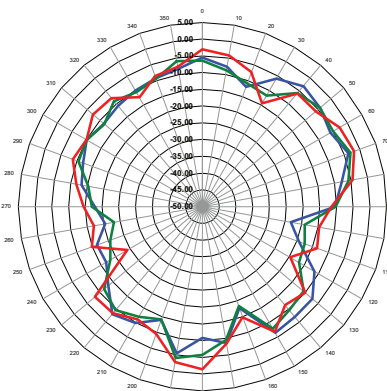

YZ-Plane Gain

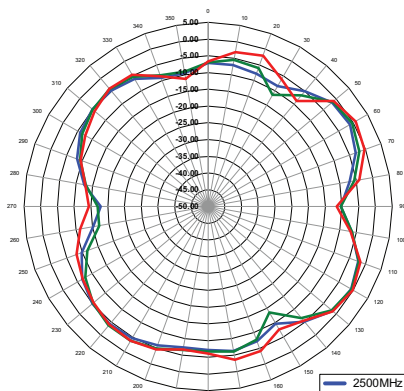

XY-Plane Gain



Gain Plots - Edge of Plane, Bent 90°

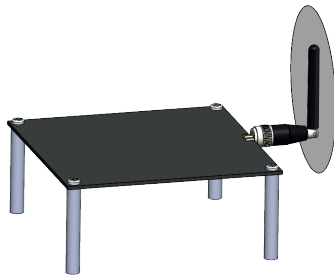

XZ-Plane Gain

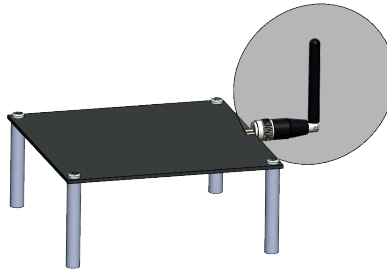

YZ-Plane Gain

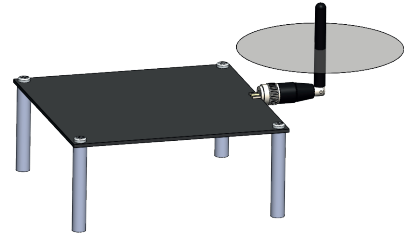

XY-Plane Gain

3400 - 3600MHz

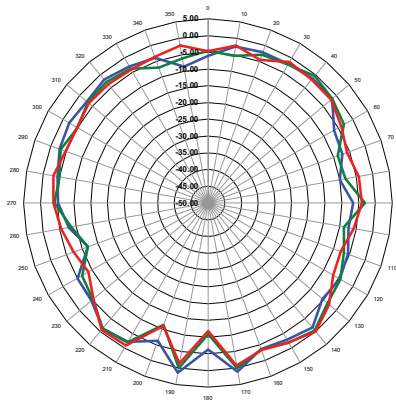

XZ-Plane Gain

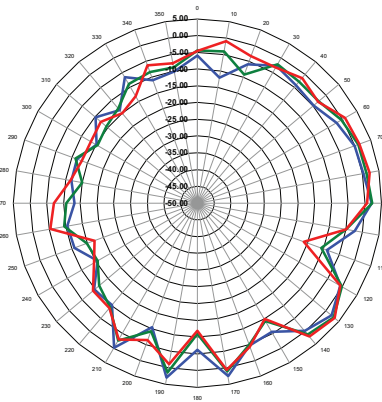

YZ-Plane Gain

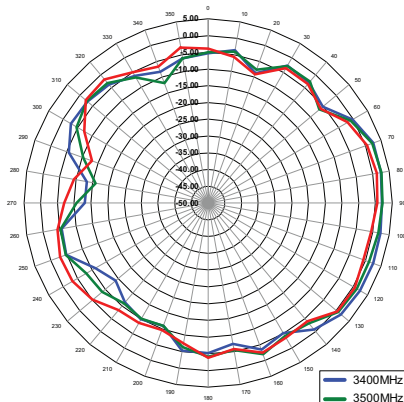

XY-Plane Gain



3600 - 3800MHz

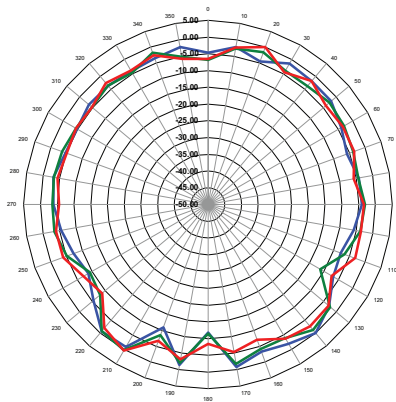

XZ-Plane Gain

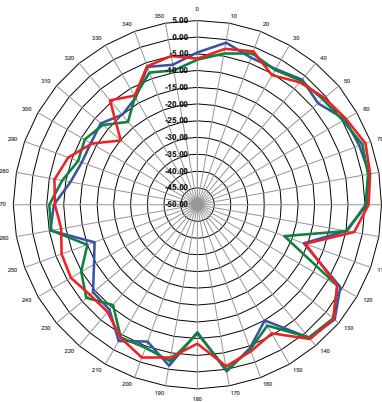

YZ-Plane Gain

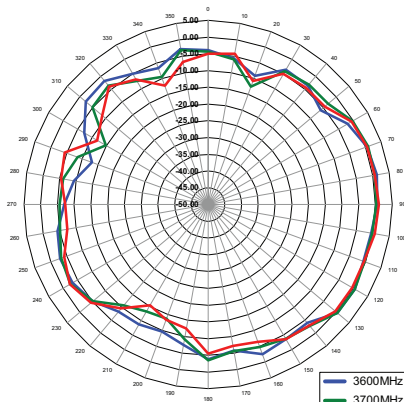

XY-Plane Gain



Center of the Ground Plane, Straight

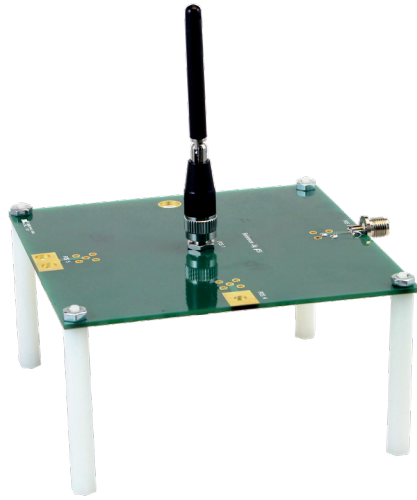

VSWR

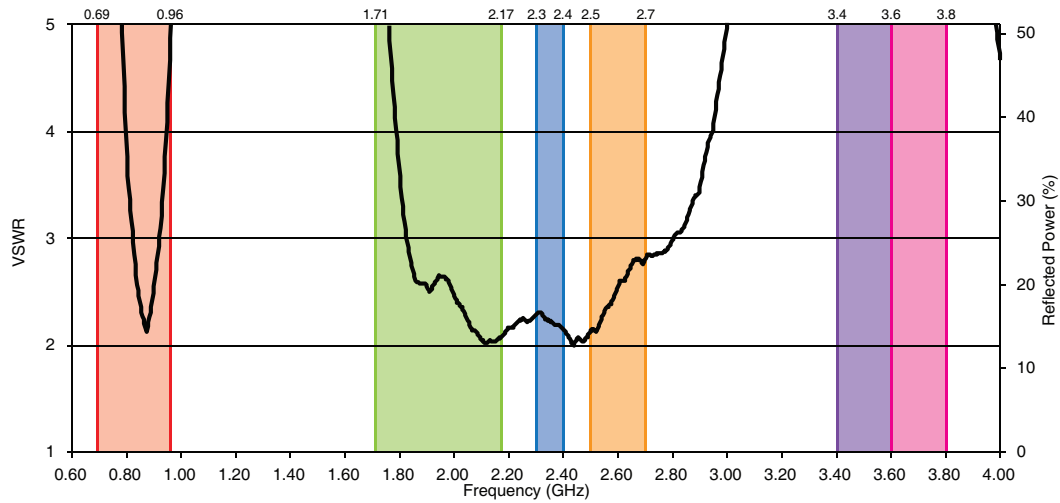

Return Loss

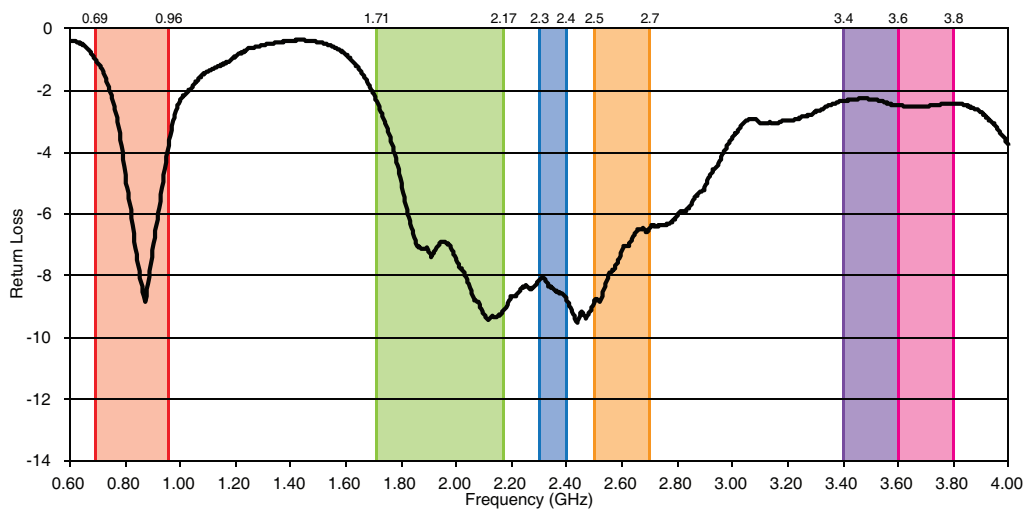

Peak Gain

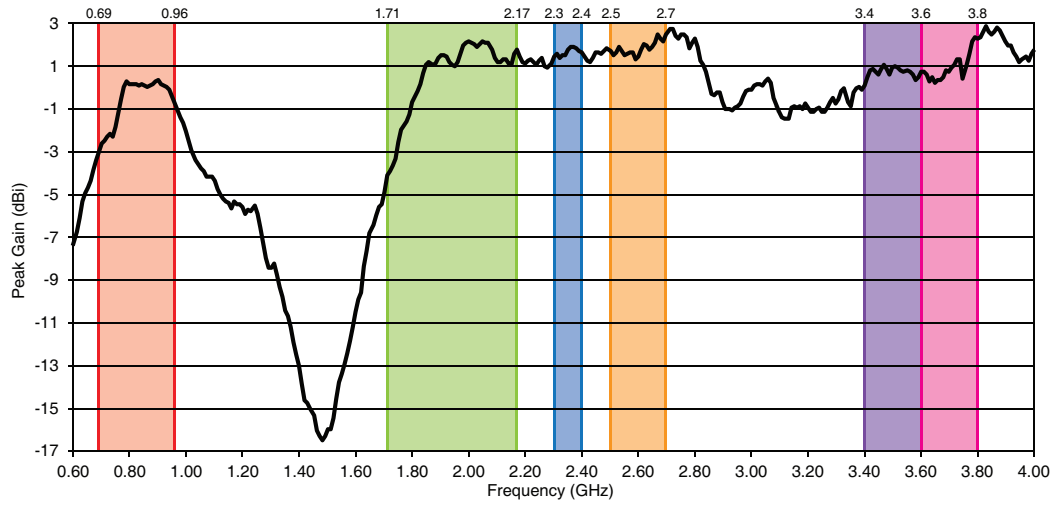

Average Gain

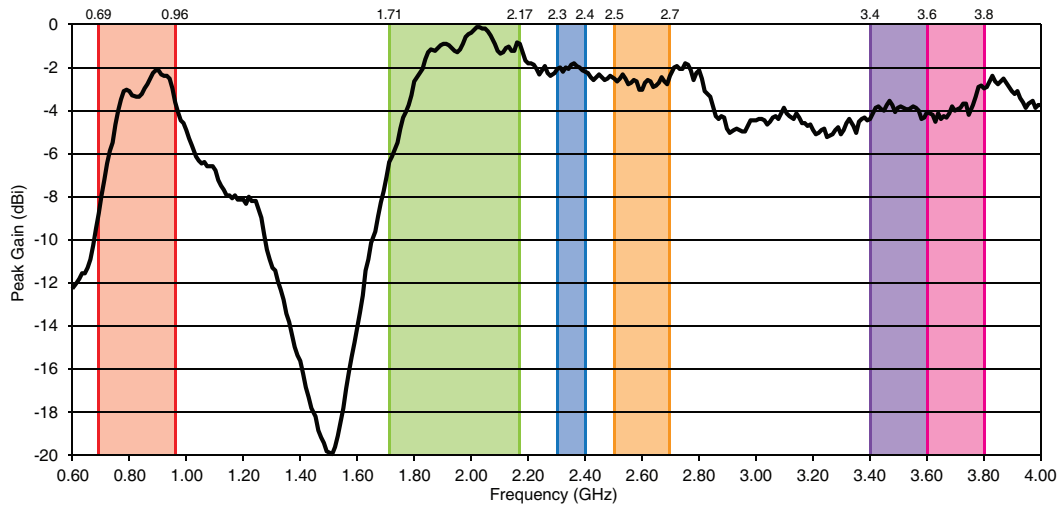

Radiation Efficiency

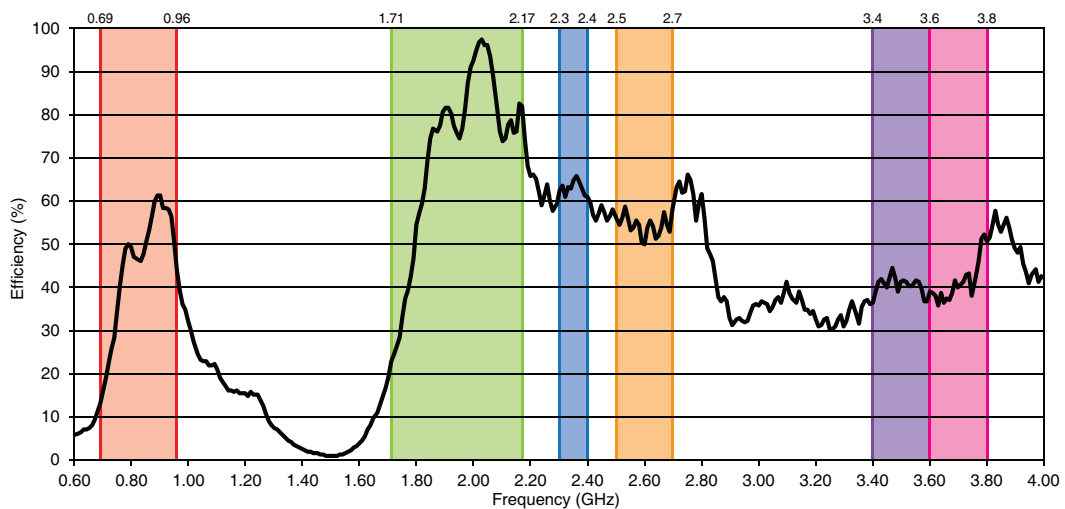

Gain Plots - Center of Plane, Straight



XZ-Plane Gain



YZ-Plane Gain

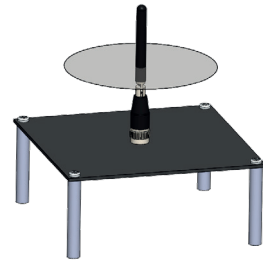

XY-Plane Gain

700 - 960MHz

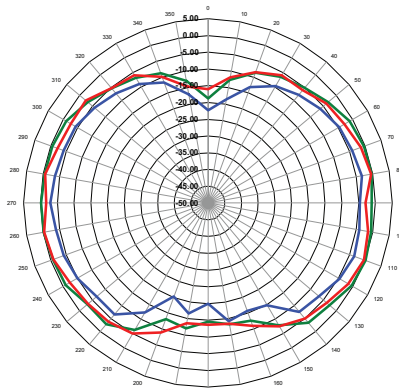

XZ-Plane Gain

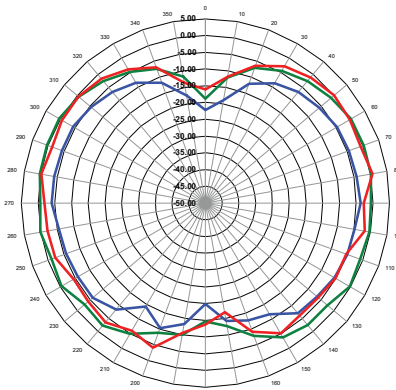

YZ-Plane Gain

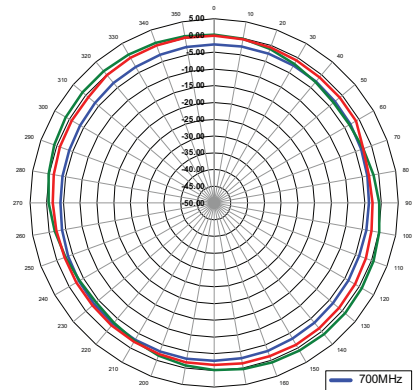

XY-Plane Gain



1710 - 2170MHz

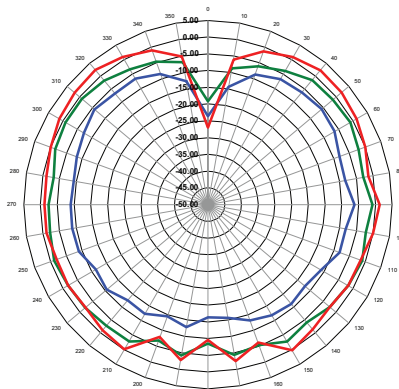

XZ-Plane Gain

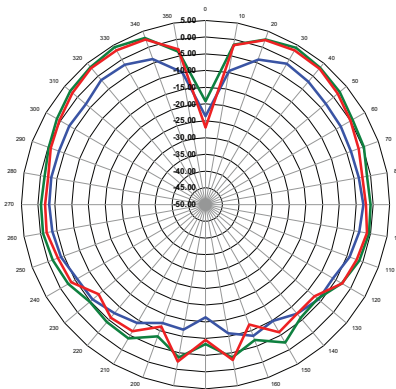

YZ-Plane Gain

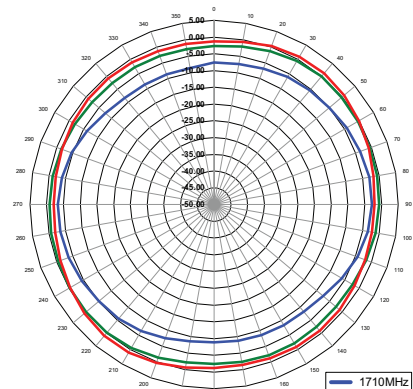

XY-Plane Gain



Gain Plots - Center of Plane, Straight



XZ-Plane Gain



YZ-Plane Gain

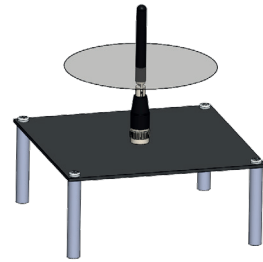

XY-Plane Gain

2300 - 2400MHz

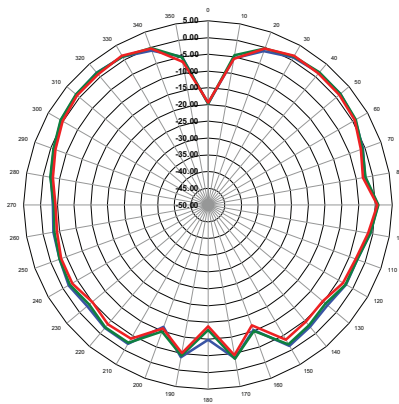

XZ-Plane Gain

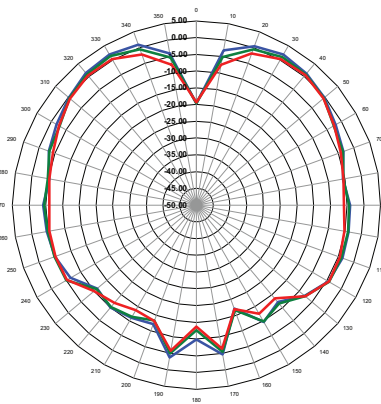

YZ-Plane Gain

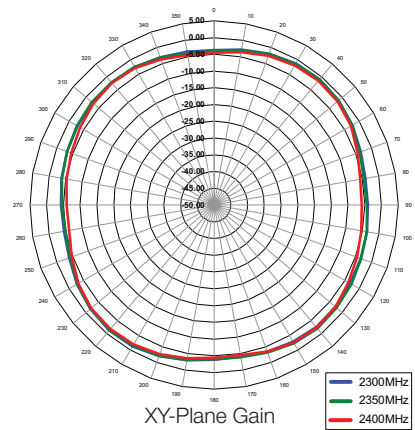

XY-Plane Gain



2500 - 2700MHz

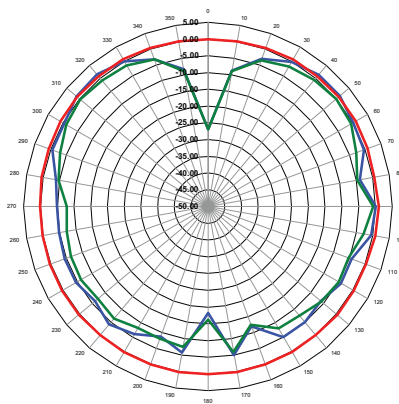

XZ-Plane Gain

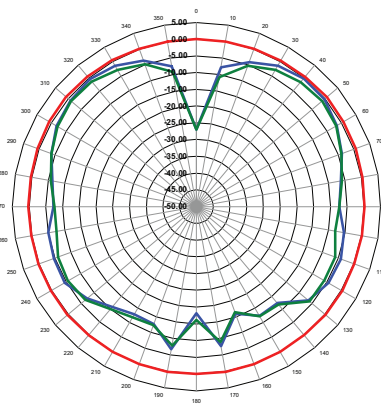

YZ-Plane Gain

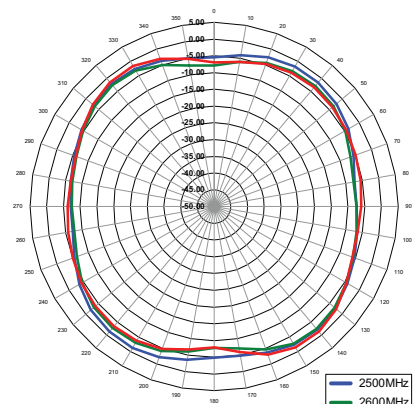

XY-Plane Gain



Gain Plots - Center of Plane, Straight



XZ-Plane Gain



YZ-Plane Gain

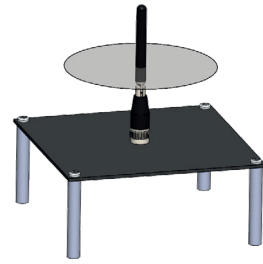

XY-Plane Gain

3400 - 3600MHz

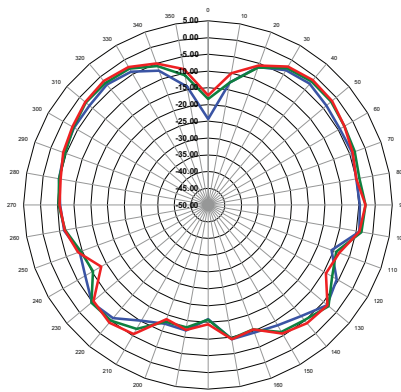

XZ-Plane Gain

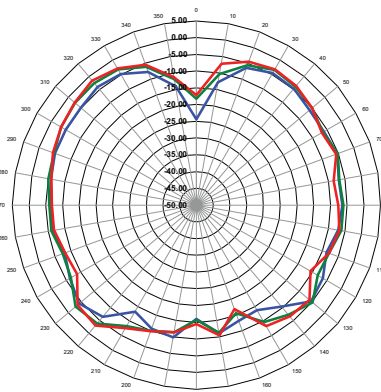

YZ-Plane Gain

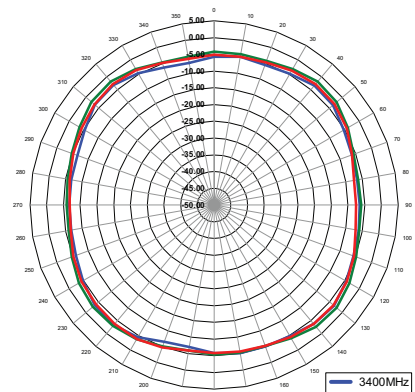

XY-Plane Gain



3600 - 3800MHz

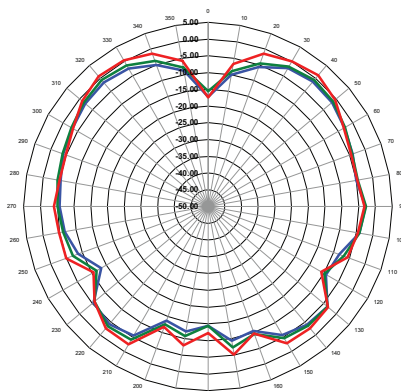

XZ-Plane Gain

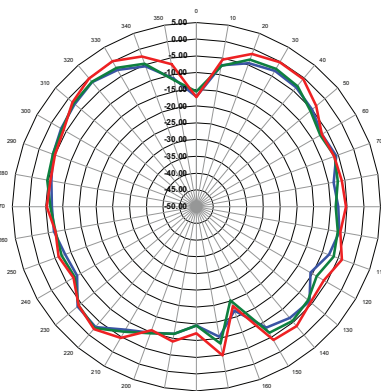

YZ-Plane Gain

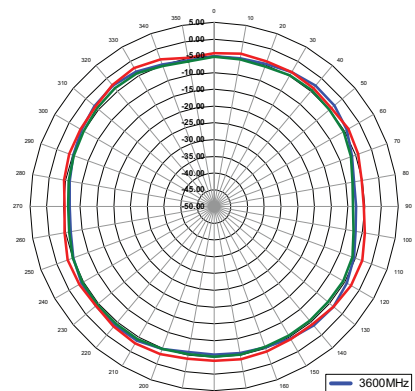

XY-Plane Gain



Matching Network

A given design may not be able to incorporate the same size ground plane as was used to design and test the antenna. The antenna's performance can vary widely with the ground plane size, which will affect the product's range and other characteristics. It is possible to adjust the performance using a matching network. This can enable the integrator to be able to optimize performance in a specific band or to level performance across all bands.

The most common matching network is a PI circuit between the antenna and the radio. This is two capacitors to ground on either side of a series inductor. The values can be selected to electrically tune the antenna. It does take test equipment such as a network analyzer to get this right.

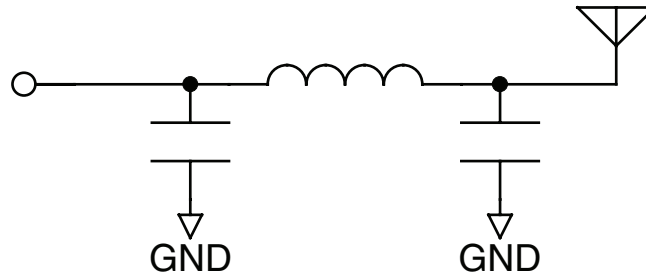

The values of the matching components are determined experimentally on the product's board. There are many variables that play into the antenna's final performance, so it is very difficult to predict what it will do on any specific design. It is best to design in the matching network, see what the antenna does on the prototype and then dial the performance in with the network components. Not all of the components may be needed on a particular design, so they do not need to be populated in production. But it is a good idea to have the component pads on the board in case they are needed.

The components should be placed close to the antenna connection. The component pads should be placed on the 50-ohm line between the radio and the antenna.

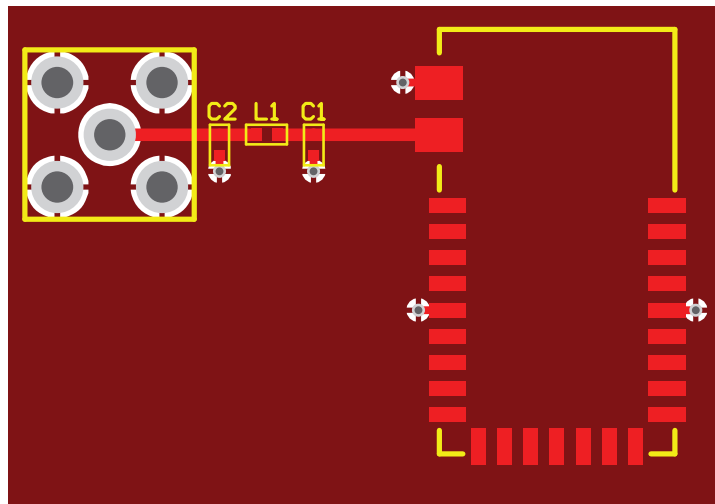

Linx Technologies offers a service to help customers tune our antennas to their circuit boards. Please contact Linx for more details.

Copyright © 2019 Linx Technologies

159 Ort Lane, Merlin, OR 97532
Phone: +1 541 471 6256
Fax: +1 541 471 6251
www.linxtechnologies.com

TE TECHNICAL SUPPORT CENTER

USA:	+1 (800) 522-6752
Canada:	+1 (905) 475-6222
Mexico:	+52 (0) 55-1106-0800
Latin/S. America:	+54 (0) 11-4733-2200
Germany:	+49 (0) 6251-133-1999
UK:	+44 (0) 800-267666
France:	+33 (0) 1-3420-8686
Netherlands:	+31 (0) 73-6246-999
China:	+86 (0) 400-820-6015

te.com

TE Connectivity, TE, TE connectivity (logo), Linx and Linx Technologies are trademarks owned or licensed by the TE Connectivity Ltd. family of companies. All other logos, products and/or company names referred to herein might be trademarks of their respective owners.

The information given herein, including drawings, illustrations and schematics which are intended for illustration purposes only, is believed to be reliable. However, TE Connectivity makes no warranties as to its accuracy or completeness and disclaims any liability in connection with its use. TE Connectivity's obligations shall only be as set forth in TE Connectivity's Standard Terms and Conditions of Sale for this product and in no case will TE Connectivity be liable for any incidental, indirect or consequential damages arising out of the sale, resale, use or misuse of the product. Users of TE Connectivity products should make their own evaluation to determine the suitability of each such product for the specific application.

TE Connectivity warrants to the original end user customer of its products that its products are free from defects in material and workmanship. Subject to conditions and limitations TE Connectivity will, at its option, either repair or replace any part of its products that prove defective because of improper workmanship or materials. This limited warranty is in force for the useful lifetime of the original end product into which the TE Connectivity product is installed. Useful lifetime of the original end product may vary but is not warranted to exceed one (1) year from the original date of the end product purchase.

©2023 TE Connectivity. All Rights Reserved.

04/23 Original