

REVISIONS					
P	LTR	DESCRIPTION	DATE	DWN	APVD
	A	REVISED PER PCN E-17-005334	18MAR2017	CM	DM

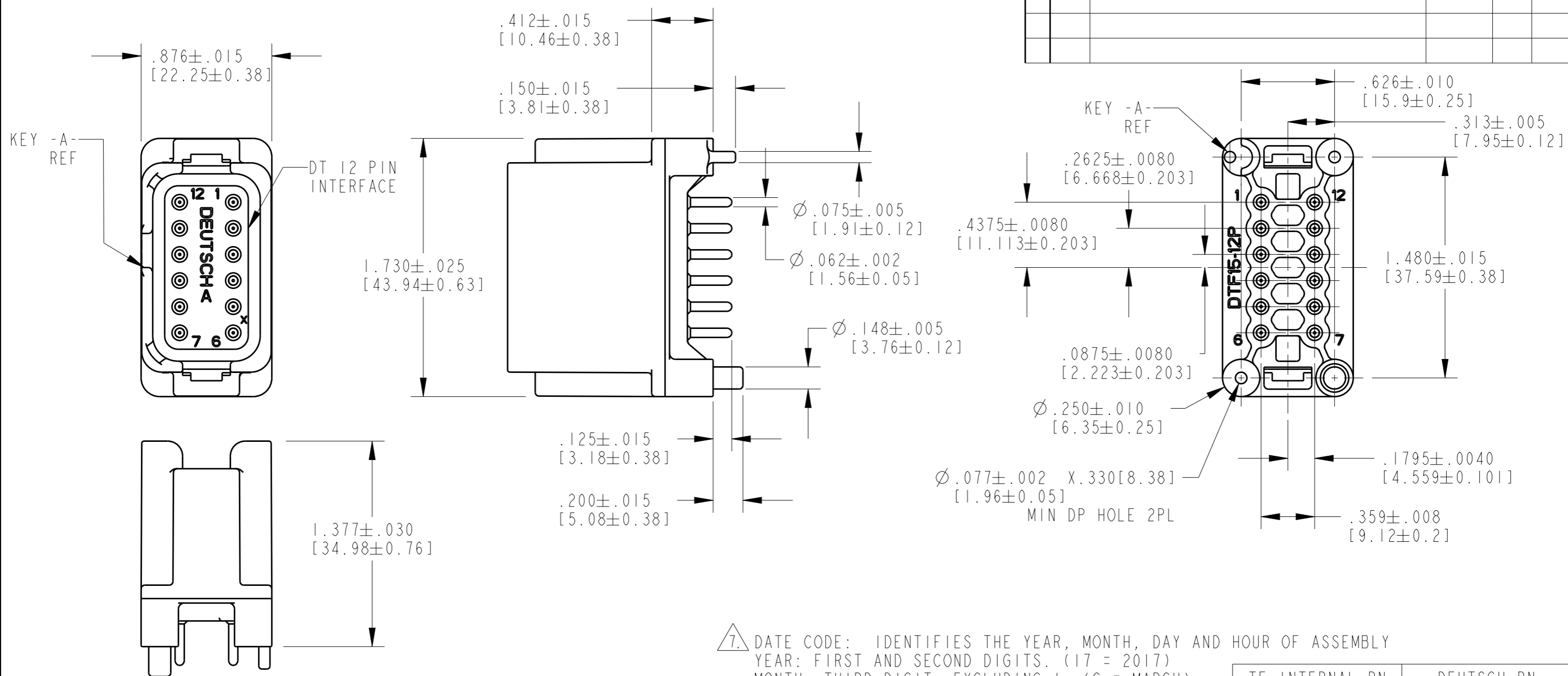

5. RECOMMENDED SCREW: 2-28 [M2.26 X 0.91] PLASTITE 48, SINGLE HELIX TORQUE: 0.75-1.5 IN-LB [0.08-0.16 N-m].

4. THE RECEPTACLE MATES WITH DT06-12SX-XXXX PLUG (X=A,B,C,D KEYS; XXXX=ALL MODIFICATIONS)

3. PIN PLATING:
 MATING SIDE: GOLD (-G003 MOD)
 PCB SIDE: TIN (ROHS)

2. MATERIAL:
 RECEPTACLE: PA46 GF30
 PIN: COPPER ALLOY

1. DIMENSIONAL TOLERANCES: ±.025 [.64]

NOTES:

7. DATE CODE: IDENTIFIES THE YEAR, MONTH, DAY AND HOUR OF ASSEMBLY
 YEAR: FIRST AND SECOND DIGITS. (17 = 2017)
 MONTH: THIRD DIGIT, EXCLUDING 1. (C = MARCH)
 DAY: FOURTH AND FIFTH DIGITS (21 = 21ST DAY)
 HOUR: SIXTH AND SEVENTH DIGITS. (16 = 4-5PM)

6. RECEPTACLE TO BE POTTED IN PLACE.
 POTTING DEPTH TO BE .600 [15.24] MAX FOR PCB.

TE INTERNAL PN	DEUTSCH PN
DTF15-12PA-G003	DTF15-12PA-G003
DTF15-12PB-G003	DTF15-12PB-G003
DTF15-12PC-G003	DTF15-12PC-G003
DTF15-12PD-G003	DTF15-12PD-G003

THIS DRAWING IS A CONTROLLED DOCUMENT.		DWN M. GONZALEZ	L1MAR2004	
DIMENSIONS: INCHES [mm]		CHK -	APVD 22MAR2004	
TOLERANCES UNLESS OTHERWISE SPECIFIED:		NAME 12 WAY RECEPTACLE 16 SIZE PINS -G003 MOD DTF SERIES		
0 PLC ±	1 PLC ±	PRODUCT SPEC -		
2 PLC ±	3 PLC ±	APPLICATION SPEC -		
4 PLC ±	ANGLES ±0° 30' 0"	SIZE A3	CAGE CODE 4AFU8	DRAWING NO DTF15-12PX-G003
MATERIAL	FINISH	WEIGHT -		RESTRICTED TO -
2	3	CUSTOMER DRAWING		SCALE 1.5:1
		SHEET 1 OF 2		REV A

REVISIONS

P	LTR	DESCRIPTION	DATE	DWN	APVD
-	-	SEE SHEET 1	-	-	-

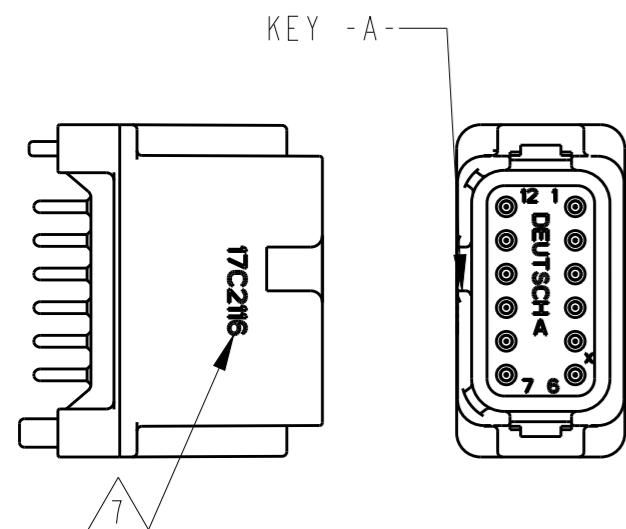

DTF15-12PA-G003
KEY -A-
 COLOR: GRAY

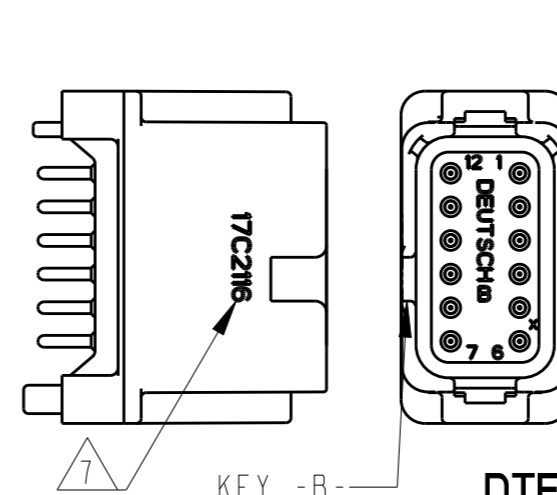
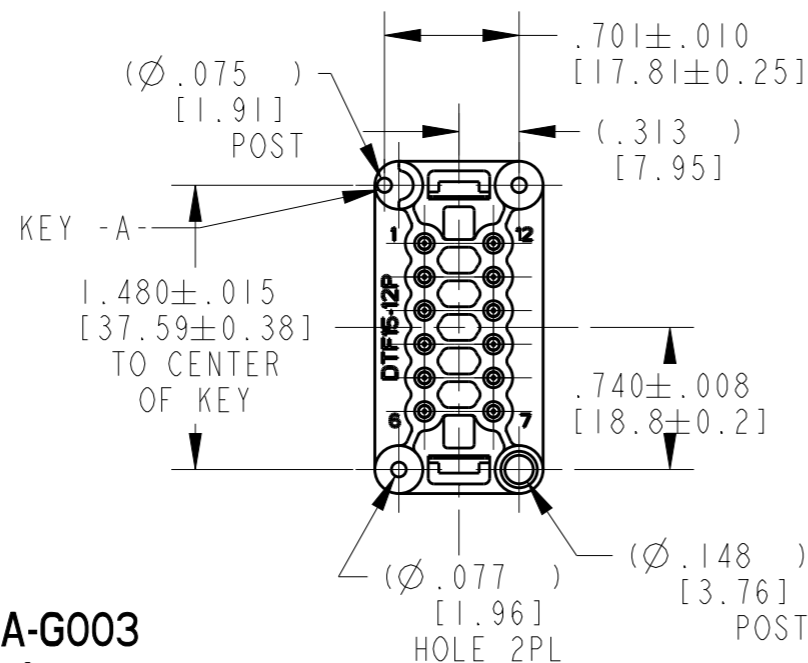

DTF15-12PB-G003
KEY -B-
 COLOR: BLACK

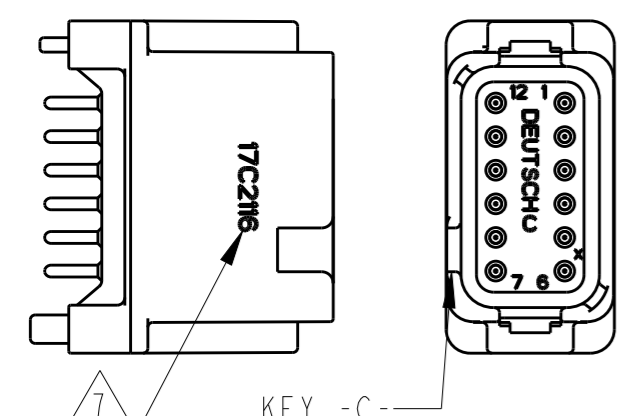
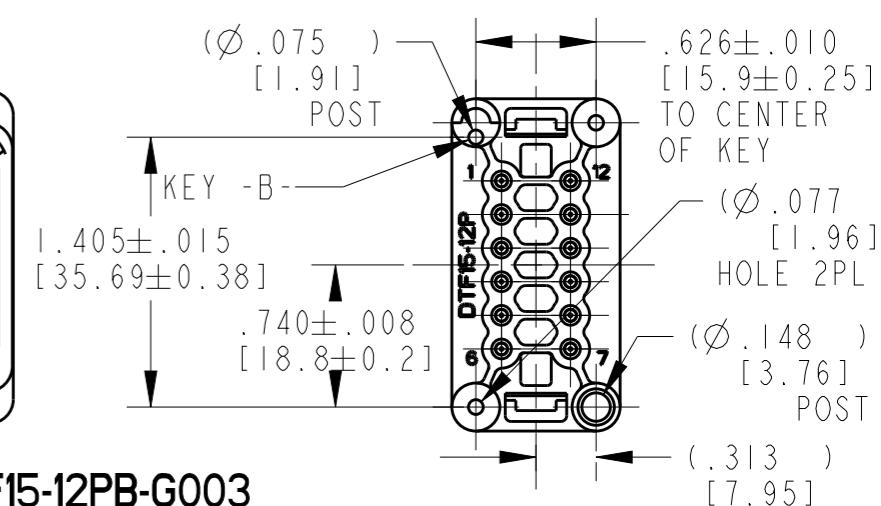

DTF15-12PC-G003
KEY -C-
 COLOR: GREEN

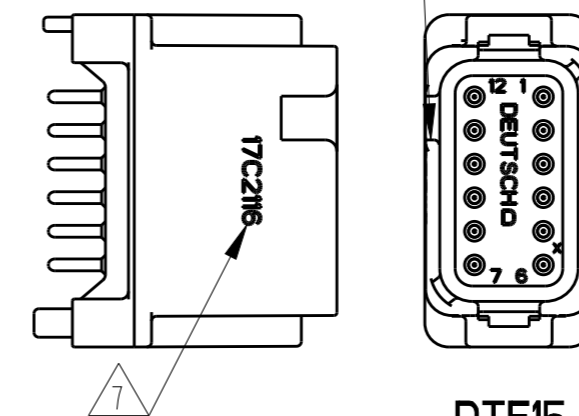
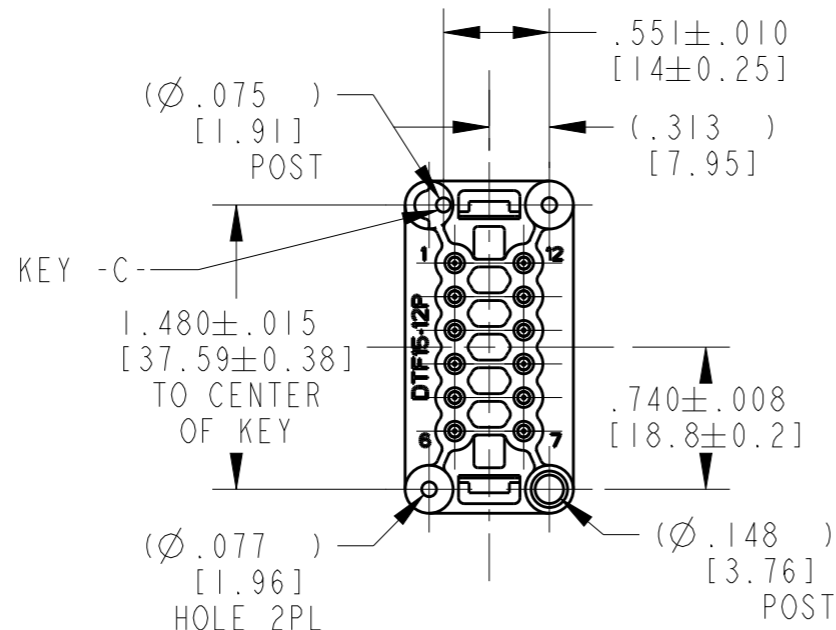

DTF15-12PD-G003
KEY -D-
 COLOR: BROWN

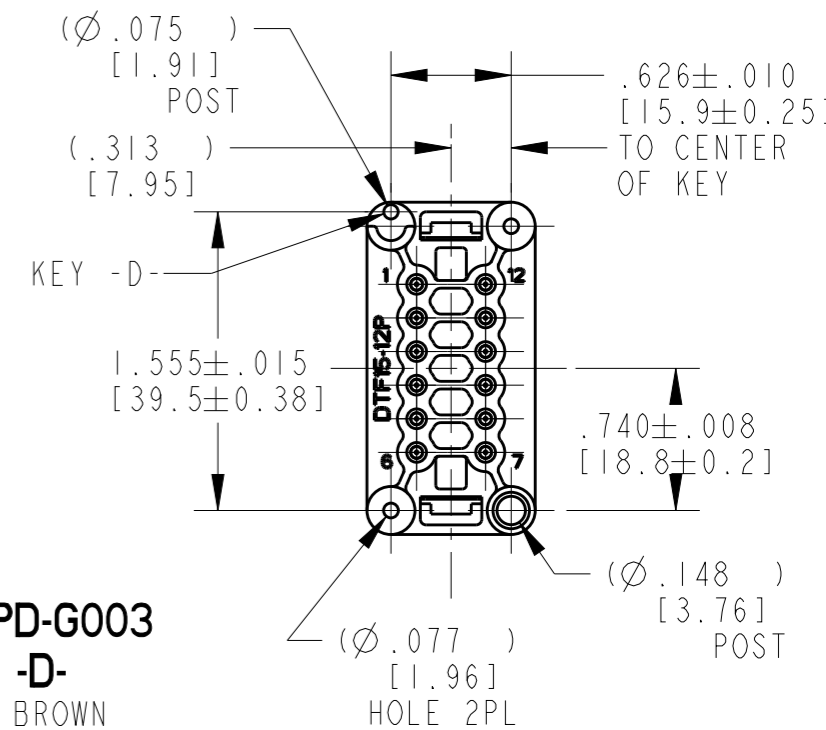

THIS DRAWING IS A CONTROLLED DOCUMENT.		DWN M. GONZALEZ	LIMAR2004	TE TE Connectivity
DIMENSIONS: INCHES [mm]		CHK -	APVD 22MAR2004	
TOLERANCES UNLESS OTHERWISE SPECIFIED:		PRODUCT SPEC -		NAME 12 WAY RECEPTACLE 16 SIZE PINS -G003 MOD DTF SERIES
0 PLC ±		APPLICATION SPEC -		
1 PLC ±		WEIGHT -		SIZE A3
2 PLC ±		CUSTOMER DRAWING		CAGE CODE 4AFU8
3 PLC ±.025 [0.64]		SCALE 1:1		DRAWING NO DTF15-12PX-G003
4 PLC ±		SHEET 2 OF 2		RESTRICTED TO -
ANGLES ±		REV A		
±0° 30' 0"				
MATERIAL -	FINISH -			