

THIS DRAWING IS UNPUBLISHED. RELEASED FOR PUBLICATION 20
 © COPYRIGHT 20 BY - ALL RIGHTS RESERVED.

REVISIONS					
P	LTR	DESCRIPTION	DATE	DWN	APVD
	B	INITIAL	19SEP2017	YC	CW

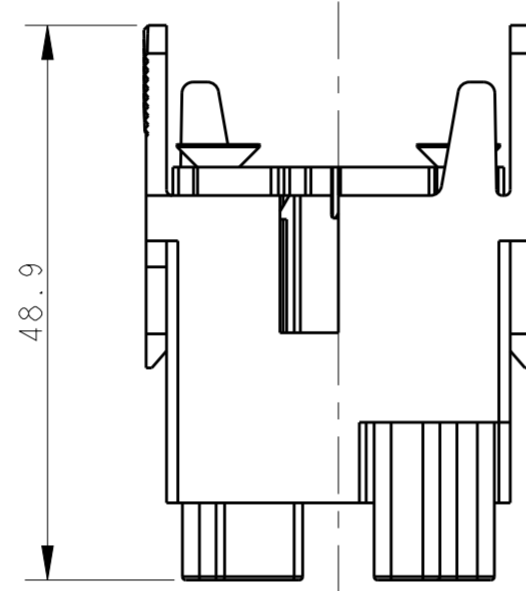
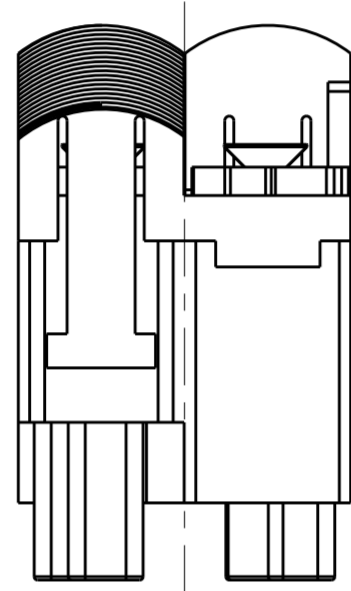
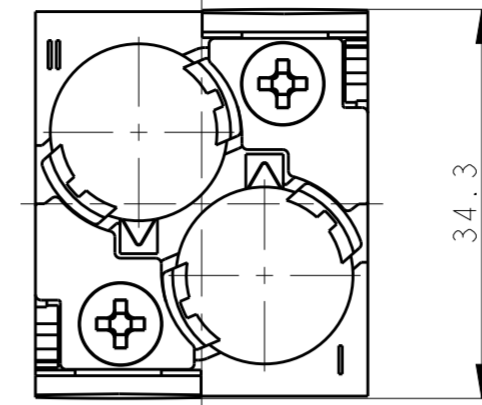
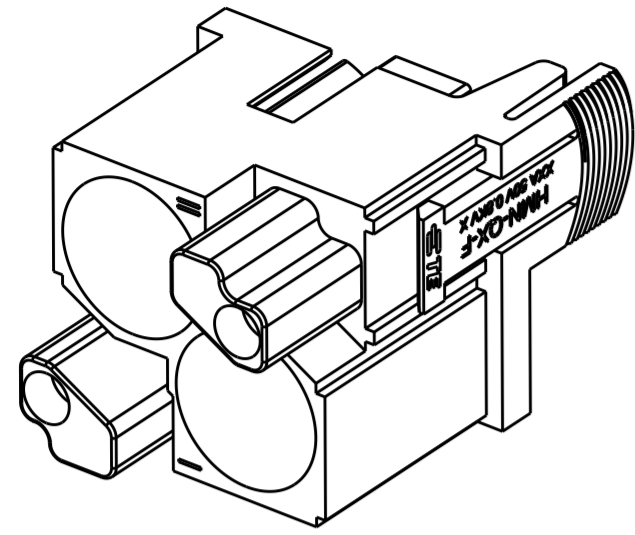

"XX"A SEE TABLE
 "XX"指代产品额定电流,见表格

"X" STAND FOR POLLUTION DEGREE(PD) SEE TABLE
 "X"指代产品污染等级,见表格

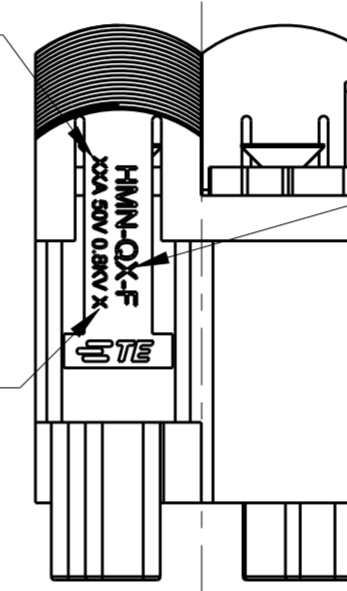

"X" FOR TYPE SEE TABLE
 "X"指代产品类型,见表格

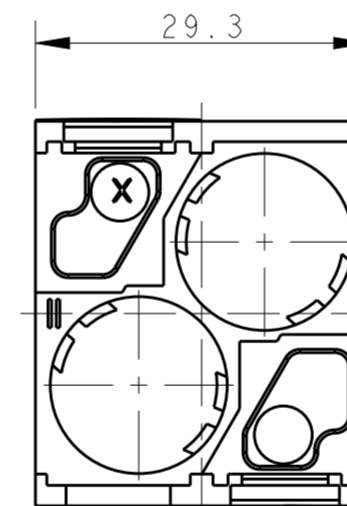

- NOTES:
- TECHNICAL CHARACTERISTICS:
 INSULATION MATERIAL: PC
 RATED VOLTAGE: 50V
 RATED CURRENT: SEE TABLE
 INSULATION RESISTANCE: $\geq 400M\Omega$
 RATED IMPULSE VOLTAGE: 0.8KV
 POLLUTION DEGREE: SEE TABLE
 FLAMMABILITY: UL94V-0
 MATING CYCLES: 500 CYCLES
 WIRE RANGE: SEE TABLE
 CONTACT TYPE: CRIMP CONTACT
 - CONTACT NEED TO BE ORDERED SEPARATELY.

- 注释:
- 技术参数:
 绝缘材料: PC
 额定电压: 50V
 额定电流: 见表格
 绝缘电阻: $\geq 400M\Omega$
 额定脉冲电压: 0.8KV
 污染等级: 见表格
 阻燃等级: UL94V-0
 插拔次数: 500次
 接线范围: 见表格
 接线类型: 冷压接
 - 端子需要单独订购.

T2111027201-702	HMN-Q3-F	HMN-Q3 HMN-Q3	FEMALE MODULE INSERT 5A 模块母插5A	5A	2	0.08~0.52 mm ² (28~20 AWG)
T2111027201-701	HMN-Q2-F	HMN-Q2 HMN-Q2	FEMALE MODULE INSERT 10A 模块母插10A	10A	3	0.14~2.5 mm ² (26~14 AWG)
T2111027201-007	HMN-Q1-F	HMN-Q1 HMN-Q1	FEMALE MODULE INSERT 16A 模块母插16A	16A	3	0.14~4 mm ² (26~12 AWG)
PART NUMBER 料号			"X" TYPE "X" 产品型号	"XX"A "XX"电流	"X" PD "X"污染等级	WIRE GAUGE 线规

THIS DRAWING IS A CONTROLLED DOCUMENT.		DWN YORK CHEN 19SEP2017	 TE Connectivity	
DIMENSIONS: mm		CHK GINO YAO 19SEP2017		
TOLERANCES UNLESS OTHERWISE SPECIFIED:		APVD CHRIS WANG 19SEP2017	NAME HMN-Q1/Q2/Q3-F	
0 PLC ± 1 PLC ± 2 PLC ± 3 PLC ± 4 PLC ± ANGLES ± FINISH -		PRODUCT SPEC 108-137067	RESTRICTED TO	
MATERIAL		APPLICATION SPEC 114-137067	SIZE A200779	DRAWING NO C-T2111027201007
		WEIGHT	SCALE 3:2 SHEET 1 OF 1 REV B	
		CUSTOMER DRAWING		