



## ANT-5GMWS1-SMA

### Sub-6 Midband and CBRS 5G Antenna

The ANT-5GMWS1-SMA antenna is a dipole, blade-style antenna for 5G New Radio midband applications. With excellent performance from 3300 MHz to 5000 MHz the 5GMWS1 supports CBRS private cellular networking (3550 MHz to 3700 MHz), Public Safety (4940 MHz to 4990 MHz), and a growing number of 5G midband solutions.

The hinged design allows for the antenna to be positioned for optimum performance and reduces the potential for damage from impact compared to a fixed blade design. The antenna attaches with an SMA plug (male pin) connector.

#### FEATURES

- Performance at 3.55 GHz to 3.7 GHz (CBRS)
  - VSWR:  $\leq 1.3$
  - Peak Gain: 5.9 dBi
  - Efficiency: 76%
- Performance at 4.94 GHz to 4.99 GHz
  - VSWR:  $\leq 3.4$
  - Peak Gain: 2.3 dBi
  - Efficiency: 50%
- Hinged design with detents for straight, 45 degree and 90 degree positioning
- SMA plug (male pin)

#### APPLICATIONS

- 5G NR midband applications
- Private cellular networks
  - Citizens Broadband Radio Service (CBRS)
- Public Safety networks
- 5G NR bands 22, 42, 43, 48, 49, 52
- C-Band applications (3700 MHz to 4200 MHz)

#### ORDERING INFORMATION

Part Number	Description
ANT-5GMWS1-SMA	5G midband blade antenna with SMA plug (male pin)

Available from Linx Technologies and select distributors and representatives.

**TABLE 1. ELECTRICAL SPECIFICATIONS**

ANT-5GMWP1-SMA	CBRS	C-Band	Public Safety
Frequency Range	3.55 GHz to 3.7 GHz	3.7 GHz to 4.2 GHz	4.94 GHz to 4.99 GHz
VSWR (max)	1.3	3.3	3.4
Peak Gain (dBi)	5.9	5.4	2.3
Average Gain (dBi)	-1.3	-2.4	-3.2
Efficiency (%)	76	63	50
Polarization	Linear		
Radiation	Omnidirectional		
Max Power	5 W		
Wavelength	1/2-wave		
Electrical Type	Dipole		
Impedance	50 Ω		
Connection	SMA plug (male pin)		
Operating Temperature Range	-20 °C to +65 °C		
Weight	25.6 g (0.90 oz)		
Dimensions	Length: 208.6 mm (8.21 in)		

Electrical specifications and plots measured with the antenna in a free space orientation.

**PACKAGING INFORMATION**

The 5GMWS1 antennas are individually sealed in a clear plastic bag. 300 bags per carton, 400 mm x 300 mm x 230 mm (15.7 in x 11.8 in x 9.1 in), total weight 7.1 kgs (21.6 lb). Distribution channels may offer alternative packaging options.

**PRODUCT DIMENSIONS**

Figure 1 provides dimensions of the 5GMWS1 antenna. The antenna blade can be tilted 90 degrees, with a detent at 45 degrees enabling the antenna to be oriented in any direction. The rotating base allows for continuous positioning through 360 degrees even while installed.

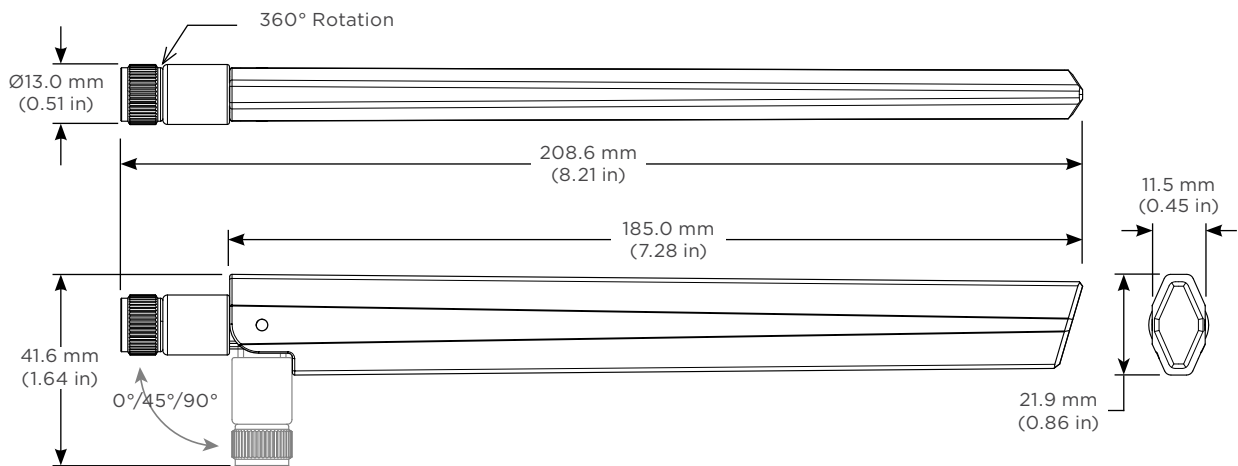

Figure 1: ANT-5GMWS1-NP Antenna Dimensions

---

## ANTENNA ORIENTATION

The 5GMWS1 antenna is characterized in two antenna orientations as shown in Figure 2. The antenna straight orientation characterizes use of an antenna attached to an enclosure-mounted connector which is connected by cable to a printed circuit board. Although the antenna is a dipole not requiring a ground plane for function, characterization with an adjacent ground plane, (102 mm x 102 mm) provides insight into antenna performance when attached directly to a printed circuit board mounted connector. The two orientations represent the most common end-product use cases.

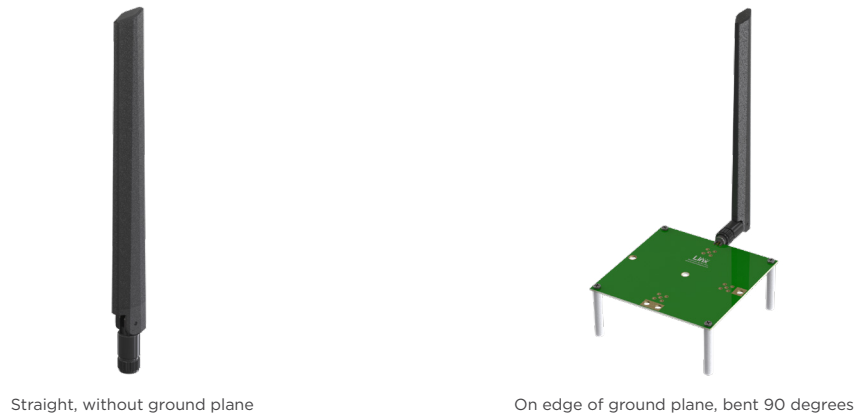

Figure 2. ANT-5GMWS1-SMA on evaluation PCB

## STRAIGHT, NO GROUND PLANE

The charts on the following pages represent data taken with the antenna oriented straight, as shown in Figure 3.



Figure 3. ANT-5GMWS1-SMA Straight, No Ground Plane (Straight)

## VSWR

Figure 4 provides the voltage standing wave ratio (VSWR) across the antenna bandwidth. VSWR describes the power reflected from the antenna back to the radio. A lower VSWR value indicates better antenna performance at a given frequency. Reflected power is also shown on the right-side vertical axis as a gauge of the percentage of transmitter power reflected back from the antenna.

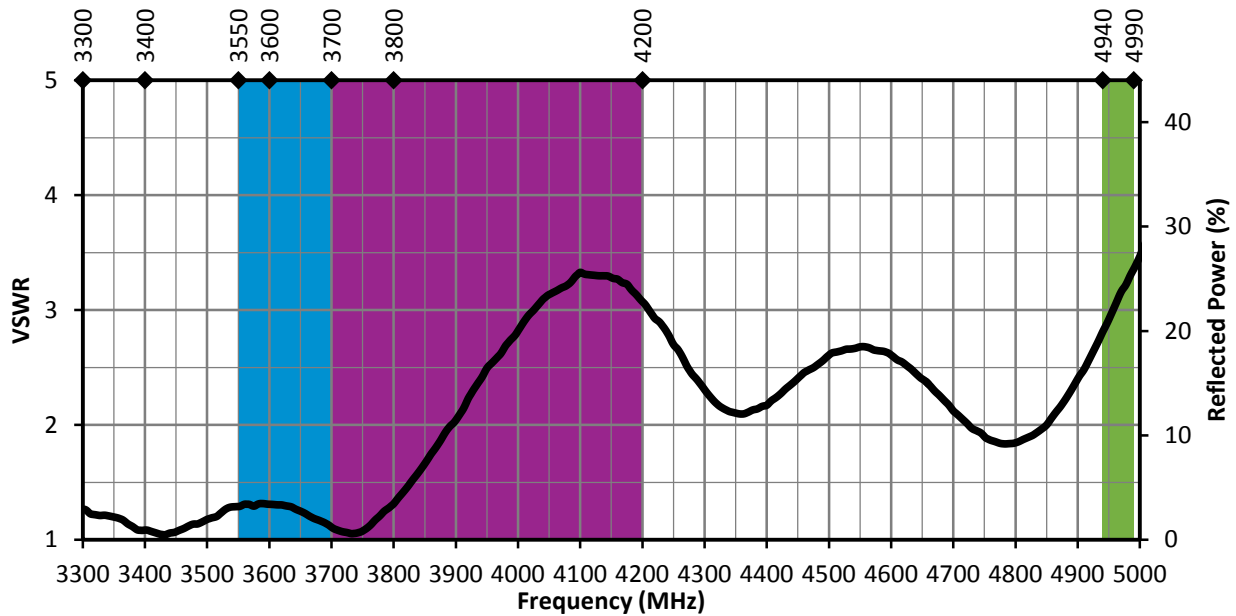

Figure 4. ANT-5GMWS1-SMA VSWR, Straight

## RETURN LOSS

Return loss (Figure 5), represents the loss in power at the antenna due to reflected signals. Like VSWR, a lower return loss value indicates better antenna performance at a given frequency.

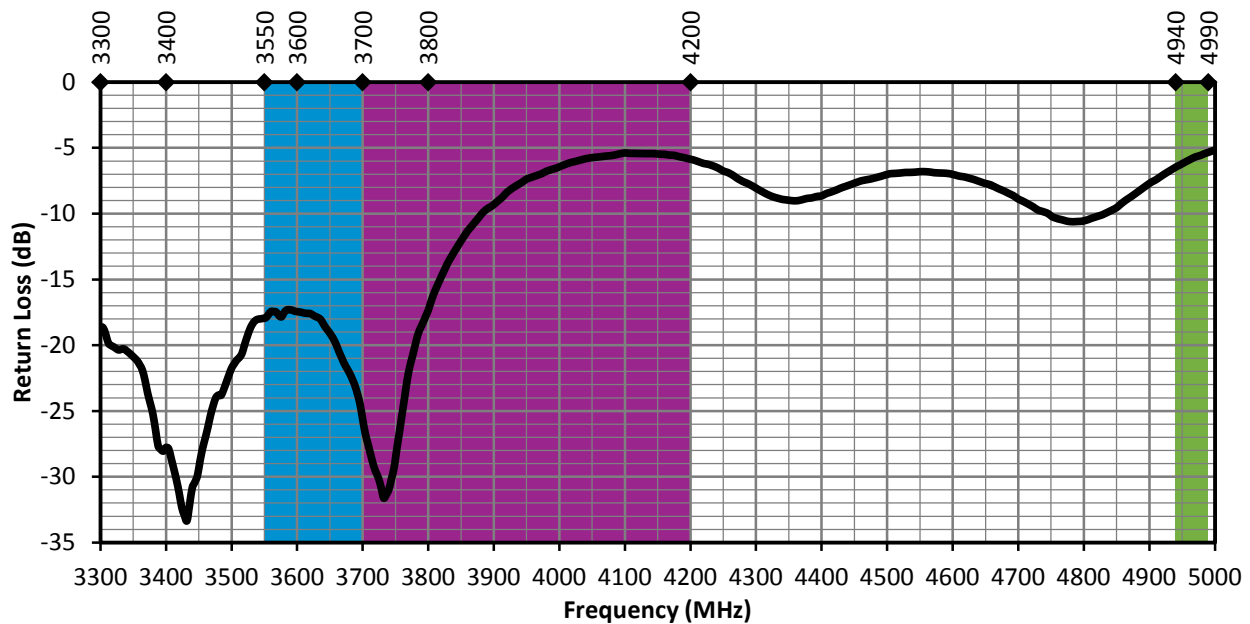

Figure 5. ANT-5GMWS1-SMA Return Loss, Straight

## PEAK GAIN

The peak gain across the antenna bandwidth is shown in Figure 6. Peak gain represents the maximum antenna input power concentration across 3-dimensional space, and therefore peak performance at a given frequency, but does not consider any directionality in the gain pattern.

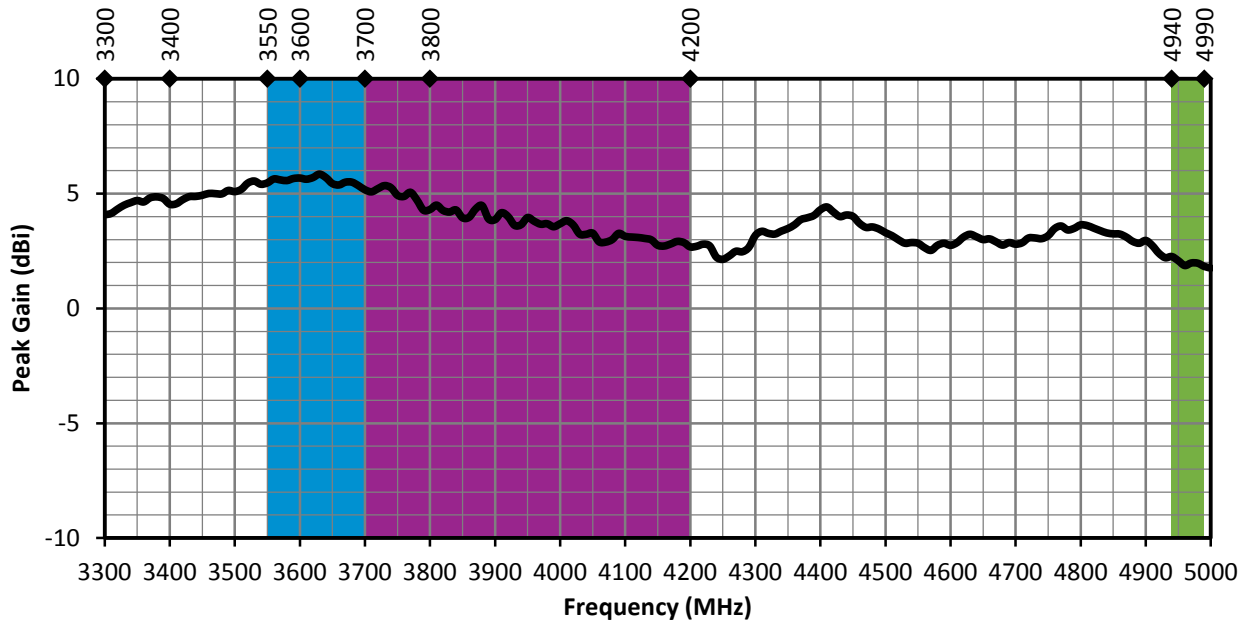

Figure 6. ANT-5GMWS1-SMA Peak Gain, Straight

## AVERAGE GAIN

Average gain (Figure 7), is the average of all antenna gain in 3-dimensional space at each frequency, providing an indication of overall performance without expressing antenna directionality.

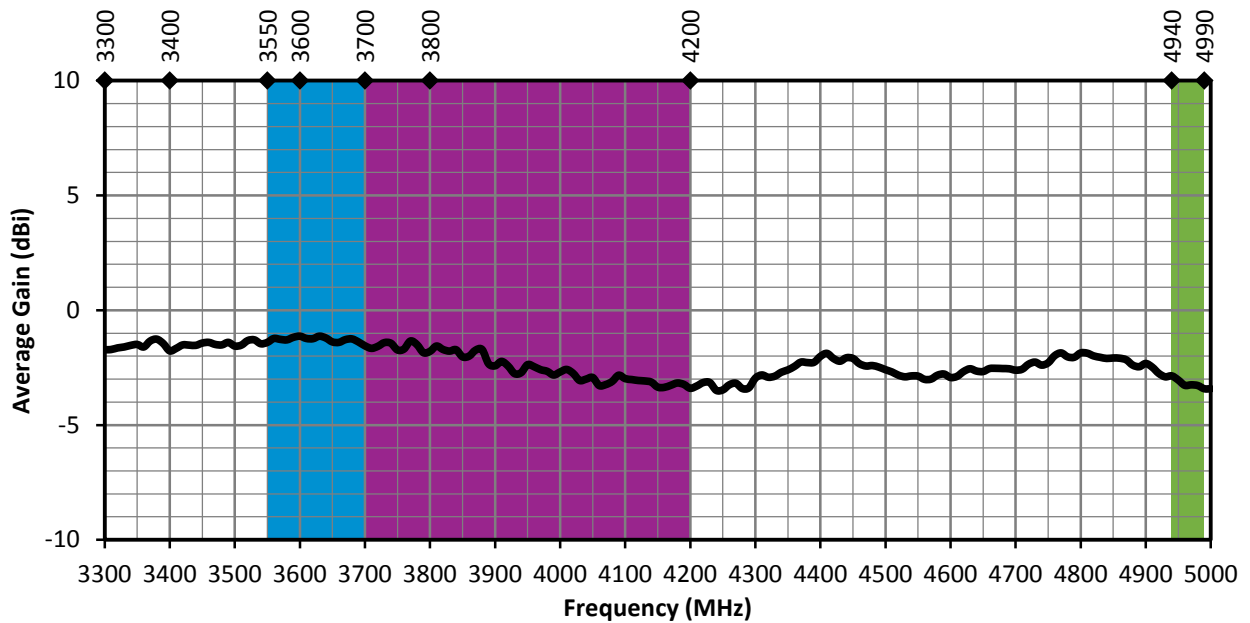

Figure 7. AANT-5GMWS1-SMA Series Antenna Average Gain, Straight

## RADIATION EFFICIENCY

Radiation efficiency (Figure 8), shows the ratio of power delivered to the antenna relative to the power radiated at the antenna, expressed as a percentage, where a higher percentage indicates better performance at a given frequency.

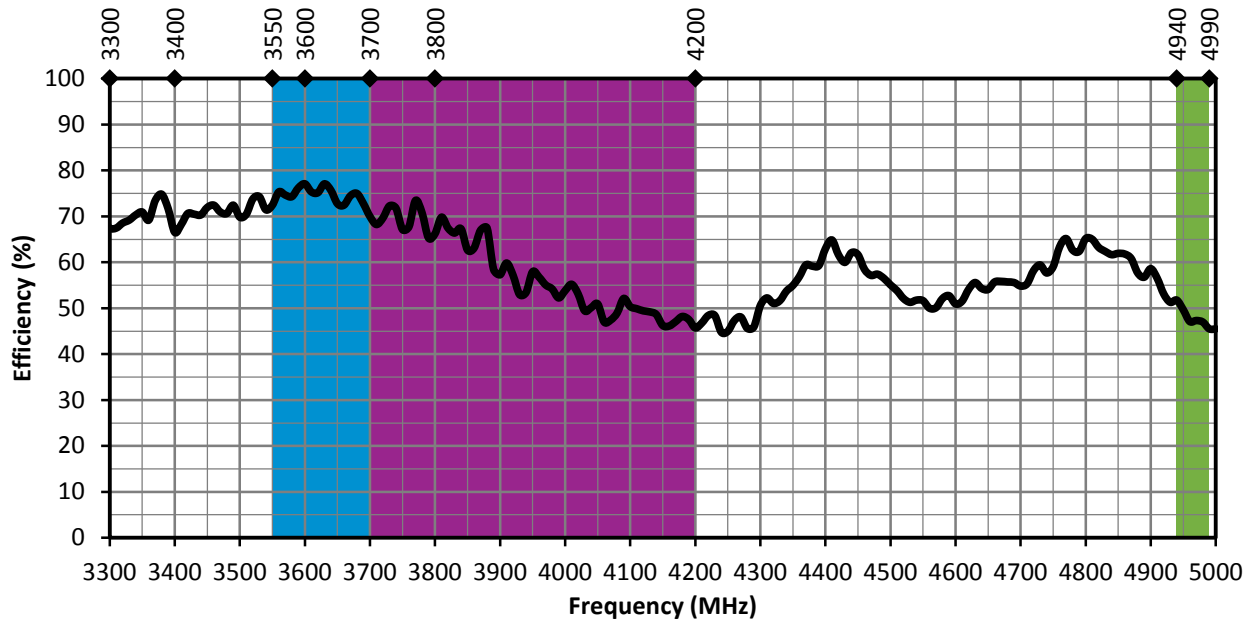
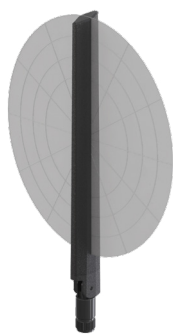

Figure 8. ANT-5GMWS1-SMA Antenna Efficiency, Straight

## RADIATION PATTERNS

Radiation patterns provide information about the directionality and 3-dimensional gain performance of the antenna by plotting gain at specific frequencies in three orthogonal planes. Antenna radiation patterns for a straight orientation are shown in Figure 9 using polar plots covering 360 degrees. The antenna graphic at the top of the page provides reference to the plane of the column of plots below it. Note: when viewed with typical PDF viewing software, zooming into radiation patterns is possible to reveal fine detail.

### RADIATION PATTERNS - FREE SPACE



XZ-Plane Gain

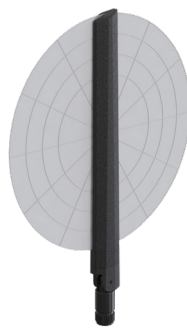

YZ-Plane Gain



XY-Plane Gain

## 3550 MHZ TO 3700 MHZ (3620 MHZ)

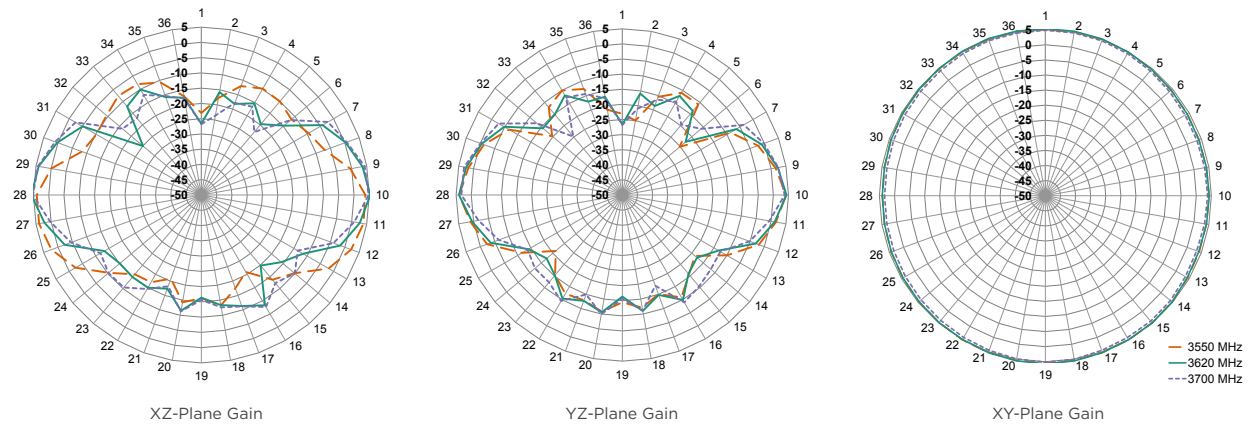

Figure 8. Radiation Patterns for the 5GMWS1, Straight

## EDGE OF GROUND PLANE, BENT 90 DEGREES

The charts on the following pages represent data taken with the antenna oriented at the edge of the ground plane, bent 90 degrees (Edge-Bent), as shown in Figure 10.

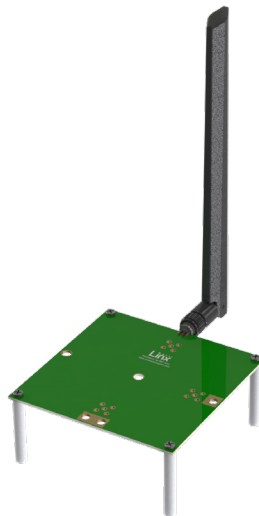

Figure 10. ANT-5GMWS1-SMA on Edge of Ground Plane, Bent 90 Degrees (Edge-Bent)

## VSWR

Figure 11 provides the voltage standing wave ratio (VSWR) across the antenna bandwidth. VSWR describes the power reflected from the antenna back to the radio. A lower VSWR value indicates better antenna performance at a given frequency. Reflected power is also shown on the right-side vertical axis as a gauge of the percentage of transmitter power reflected back from the antenna.

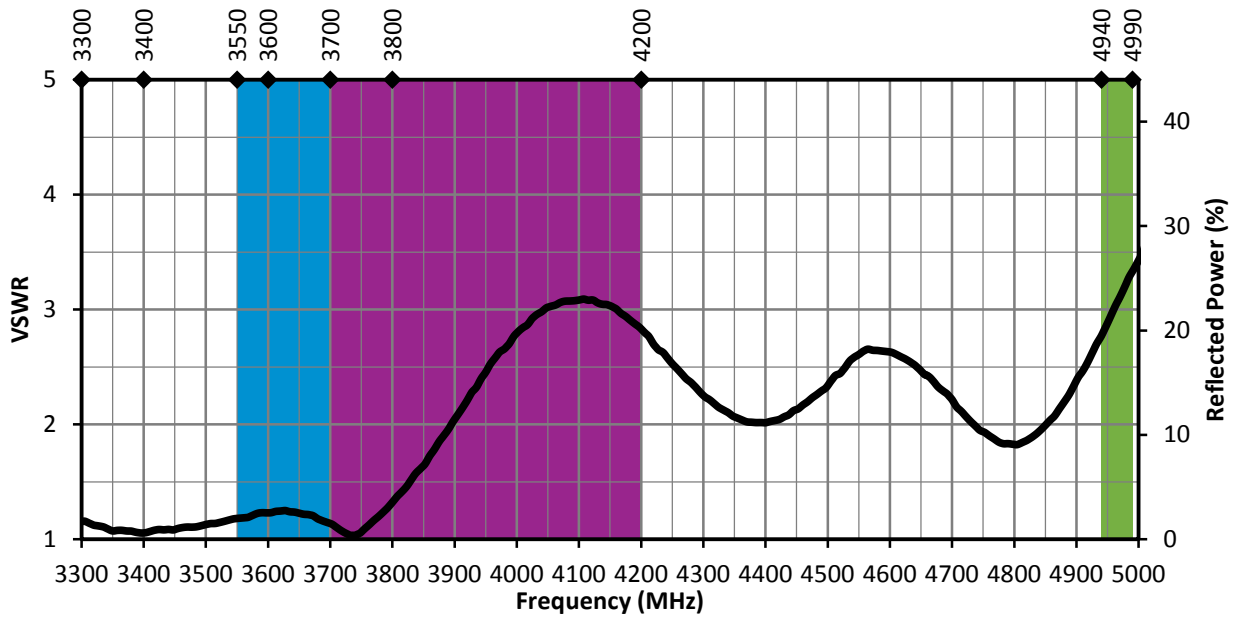

Figure 11. ANT-5GMWS1-SMA VSWR, Edge-Bent

## RETURN LOSS

Return loss (Figure 12), represents the loss in power at the antenna due to reflected signals. Like VSWR, a lower return loss value indicates better antenna performance at a given frequency.

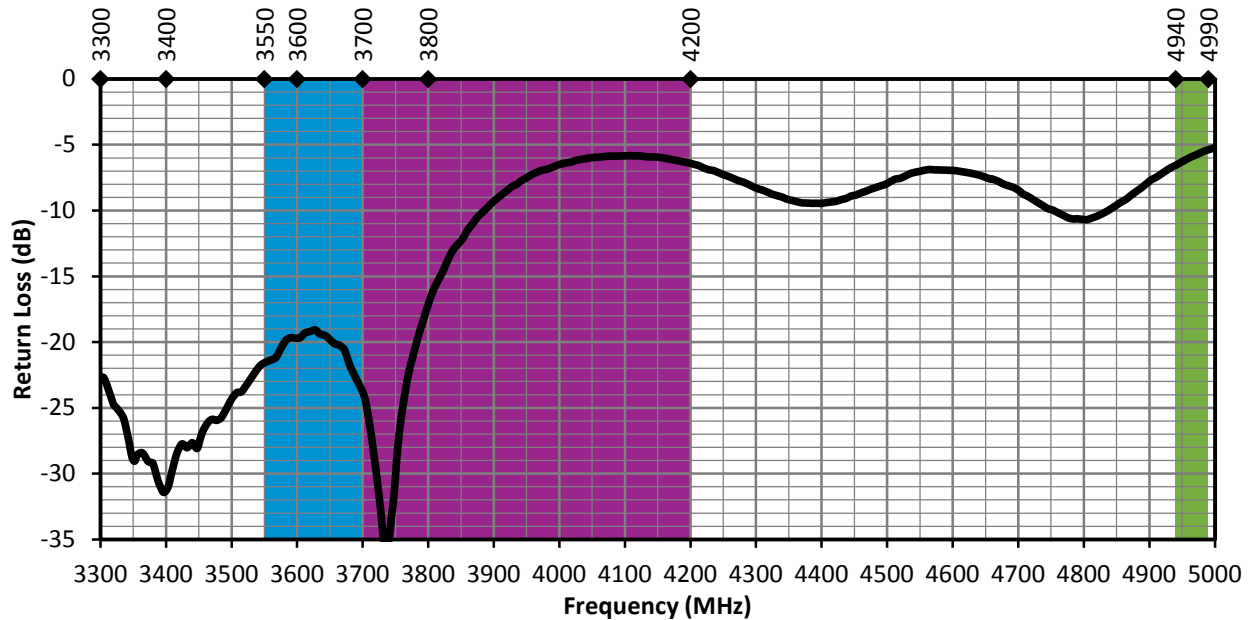

Figure 12. ANT-5GMWS1-SMA Return Loss, Edge-Bent



## PEAK GAIN

The peak gain across the antenna bandwidth is shown in Figure 13. Peak gain represents the maximum antenna input power concentration across 3-dimensional space, and therefore peak performance at a given frequency, but does not consider any directionality in the gain pattern.

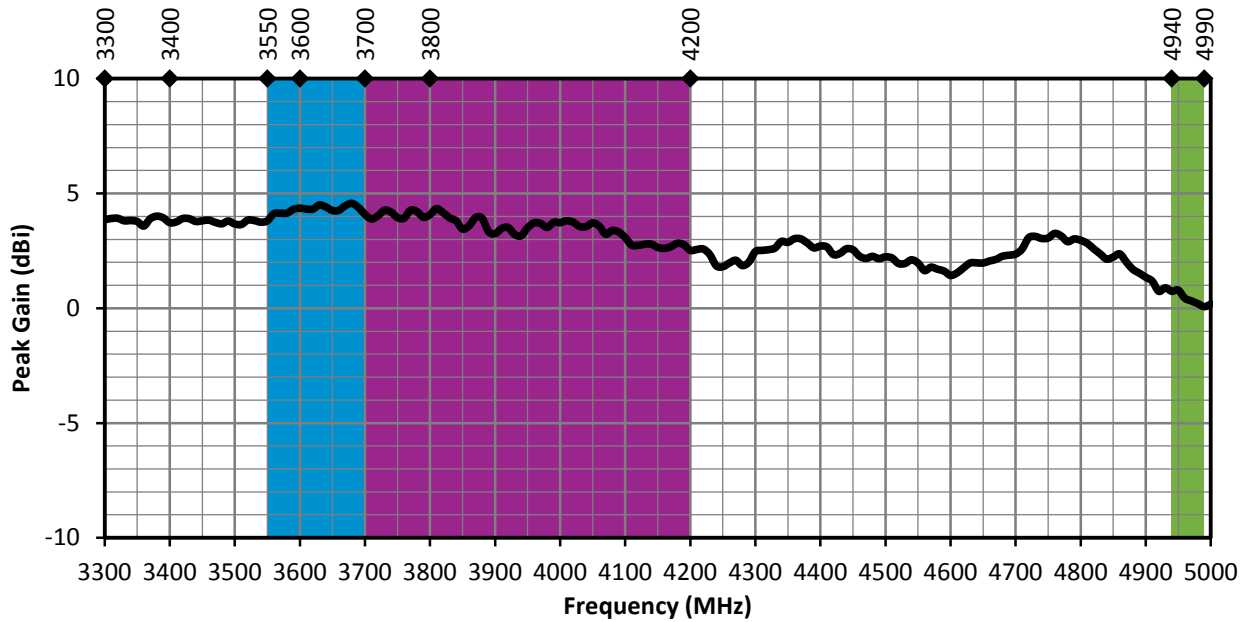

Figure 13. ANT-5GMWS1-SMA Peak Gain, Edge-Bent

## AVERAGE GAIN

Average gain (Figure 14), is the average of all antenna gain in 3-dimensional space at each frequency, providing an indication of overall performance without expressing antenna directionality.

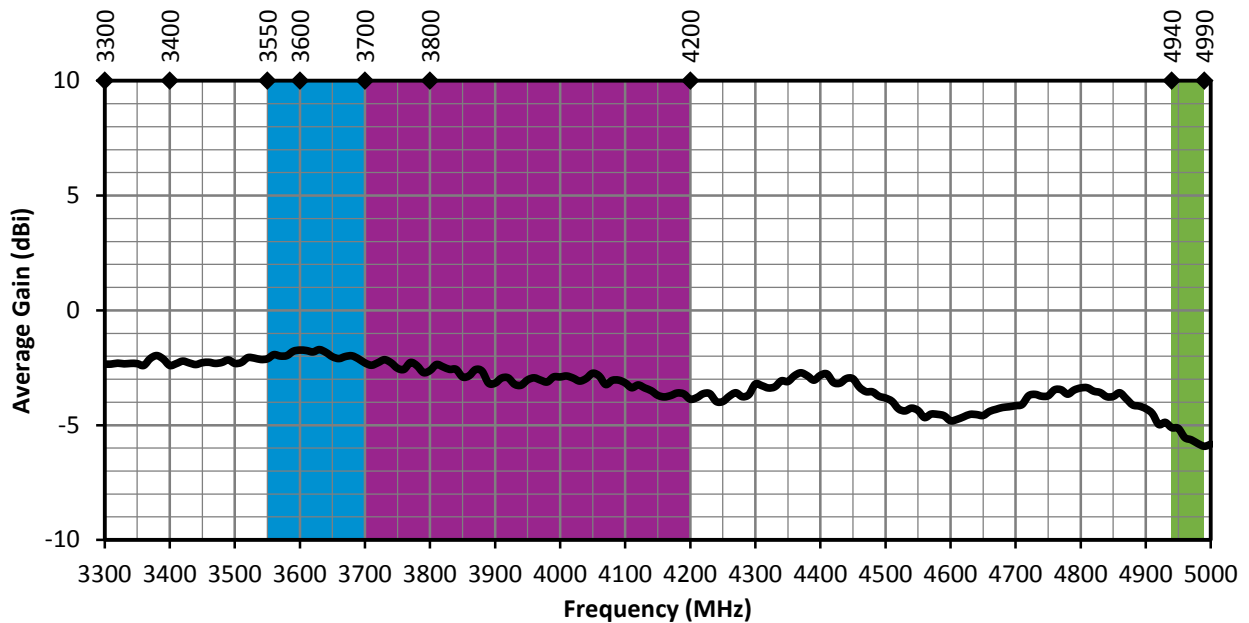

Figure 14. ANT-5GMWS1-SMA Series Antenna Average Gain, Edge-Bent

## RADIATION EFFICIENCY

Radiation efficiency (Figure 15), shows the ratio of power delivered to the antenna relative to the power radiated at the antenna, expressed as a percentage, where a higher percentage indicates better performance at a given frequency.

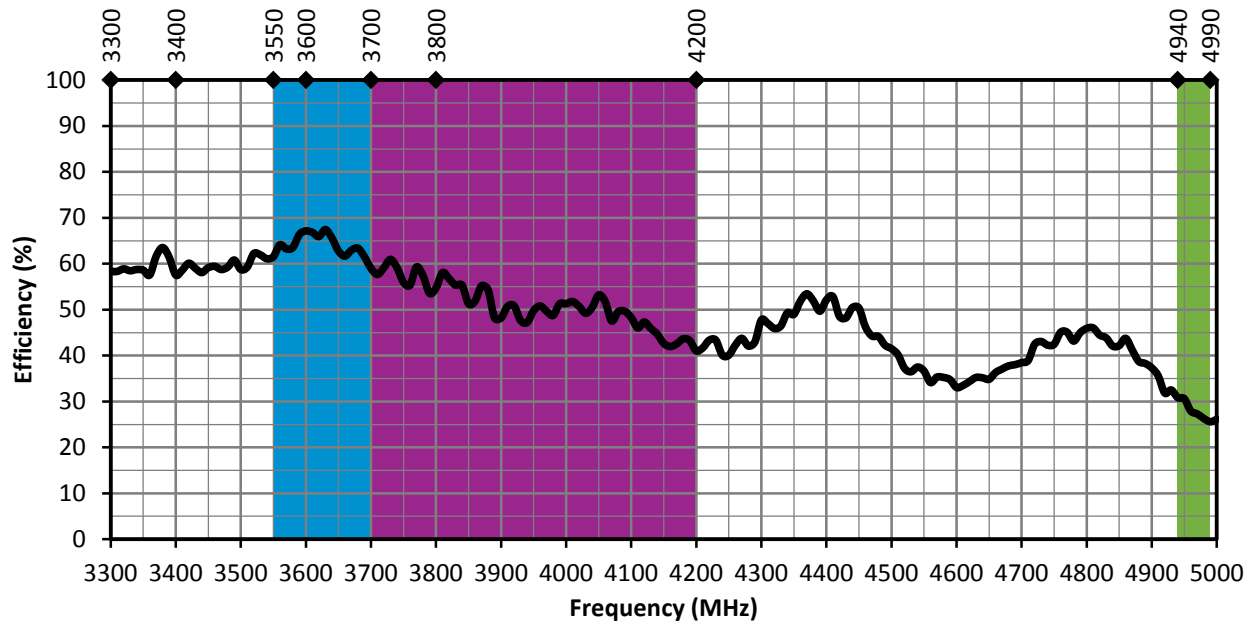
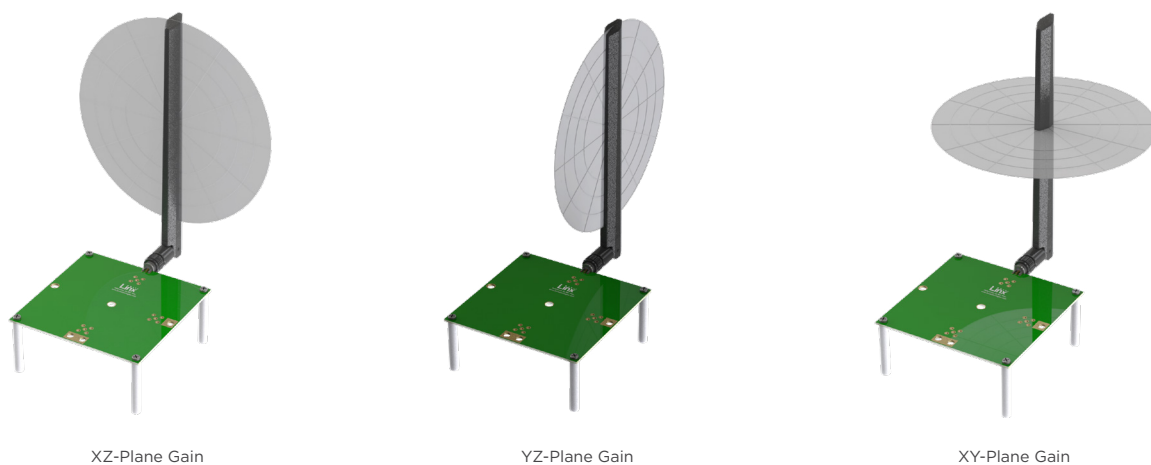

Figure 15. ANT-5GMWS1-SMA Antenna Efficiency, Edge-Bent

## RADIATION PATTERNS

Radiation patterns provide information about the directionality and 3-dimensional gain performance of the antenna by plotting gain at specific frequencies in three orthogonal planes. Antenna radiation patterns for an Edge-Bent orientation are shown in Figure 16 using polar plots covering 360 degrees. The antenna graphic at the top of the page provides reference to the plane of the column of plots below it. Note: when viewed with typical PDF viewing software, zooming into radiation patterns is possible to reveal fine detail.

### RADIATION PATTERNS - EDGE OF GROUND PLANE BENT 90 DEGREES



## 3550 MHz TO 3700 MHz (3620 MHz)

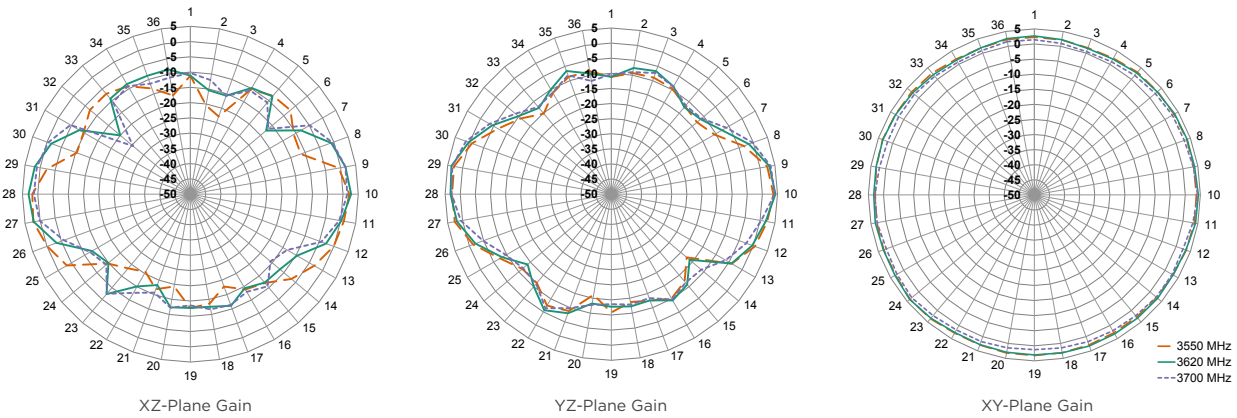

### TE TECHNICAL SUPPORT CENTER

USA:	+1 (800) 522-6752
Canada:	+1 (905) 475-6222
Mexico:	+52 (0) 55-1106-0800
Latin/S. America:	+54 (0) 11-4733-2200
Germany:	+49 (0) 6251-133-1999
UK:	+44 (0) 800-267666
France:	+33 (0) 1-3420-8686
Netherlands:	+31 (0) 73-6246-999
China:	+86 (0) 400-820-6015

### te.com

TE Connectivity, TE, TE connectivity (logo), Linx and Linx Technologies are trademarks owned or licensed by the TE Connectivity Ltd. family of companies. All other logos, products and/or company names referred to herein might be trademarks of their respective owners.

The information given herein, including drawings, illustrations and schematics which are intended for illustration purposes only, is believed to be reliable. However, TE Connectivity makes no warranties as to its accuracy or completeness and disclaims any liability in connection with its use. TE Connectivity's obligations shall only be as set forth in TE Connectivity's Standard Terms and Conditions of Sale for this product and in no case will TE Connectivity be liable for any incidental, indirect or consequential damages arising out of the sale, resale, use or misuse of the product. Users of TE Connectivity products should make their own evaluation to determine the suitability of each such product for the specific application.

TE Connectivity warrants to the original end user customer of its products that its products are free from defects in material and workmanship. Subject to conditions and limitations TE Connectivity will, at its option, either repair or replace any part of its products that prove defective because of improper workmanship or materials. This limited warranty is in force for the useful lifetime of the original end product into which the TE Connectivity product is installed. Useful lifetime of the original end product may vary but is not warranted to exceed one (1) year from the original date of the end product purchase.

©2022 TE Connectivity. All Rights Reserved.

09/22 Original