



PW Series LTE Band 8 Single-Band Monopole Antenna

PW Series antennas are rugged, low-cost and easy to install. The single frequency band of PW antennas makes the job of antenna selection simple, with better performance in the target frequency band than in multiband antennas and rejection of signals from unwanted frequencies.

The PW LTE Band 8 antenna targets 870 MHz to 960 MHz with excellent VSWR, gain and efficiency for cellular IoT (LTE-M, NB-IoT) and traditional LTE Band 8, as well as GSM and UMTS applications.

This rugged 1/4-wave monopole antenna may be used with plastic or metal enclosures and supports weather-resistant applications.

FEATURES

- Outperforms similar multiband solutions
- Durable, flexible main shaft
- Wide bandwidth
- Weather resistant for IP-rated applications
- O-ring compatible base
- Compatible with plastic and metal enclosures
- High gain (1.0 dBi at 870 MHz, 0.4 dBi at 920 MHz and 0.4 dBi at 960 MHz)
- High efficiency (60% at 870 MHz, 64% at 920 MHz and 49% at 960 MHz)

APPLICATIONS

- LTE Band 8
- LTE-M (Cat-M1) and NB-IoT cellular IoT
- GSM: P-GSM-900, E-GSM-900, R-GSM-900, T-GSM-900
- UMTS: E-GSM
- Sensing and remote monitoring
- Hand-held devices
- Internet of Things (IoT) devices
- Low-power wide-area (LPWA) networks

ORDERING INFORMATION

Part Number	Description
ANT-B8-PW-QW-UFL	LTE Band 8 PW Series antenna, with 216 mm (8.5 in) 1.32 mm coax cable terminated with an MHF1/U.FL-compatible plug (female socket)
ANT-B8-PW-QW	LTE Band 8 PW Series antenna, with 216 mm (8.5 in) unterminated RG-174 coax cable

Available from Linx Technologies and select distributors and representatives.

Notes

1. Use of an O-ring is recommended, IP-ratings cannot be guaranteed
2. With appropriate counterpoise

ELECTRICAL SPECIFICATIONS

	ANT-B8-PW-QW-ccc
Frequency Range	870 MHz to 960 MHz
Center Frequency	920 MHz
VSWR (max)	2.0
Peak Gain (dBi)	1.6
Polarization	Linear
Radiation	Omnidirectional
Max Power	10 W
Wavelength	1/4-wave
Impedance	50 Ω
Connection	MHF1/U.FL-compatible plug (female socket) on 1.32 mm cable or unterminated RG-174 cable
Cable Length	216 mm (8.5 in)
Height	80.5 mm (3.17 in)
Weight	ANT-B8-PW-QW = 19.9 g (0.70 oz) ANT-B8-PW-QW-UFL = 18.8 g (0.66 oz)
Operating Temperature	-40 °C to +90 °C

Electrical specifications and plots measured with a 102 mm x 102 mm (4 in x 4 in) reference ground plane.

VSWR

Figure1 and Figure2 provide the voltage standing wave ratio (VSWR) across the antenna bandwidth. VSWR describes the power reflected from the antenna back to the radio. A lower VSWR value indicates better antenna performance at a given frequency. Reflected power is also shown on the right-side vertical axis as a gauge of the percentage of transmitter power reflected back from the antenna.

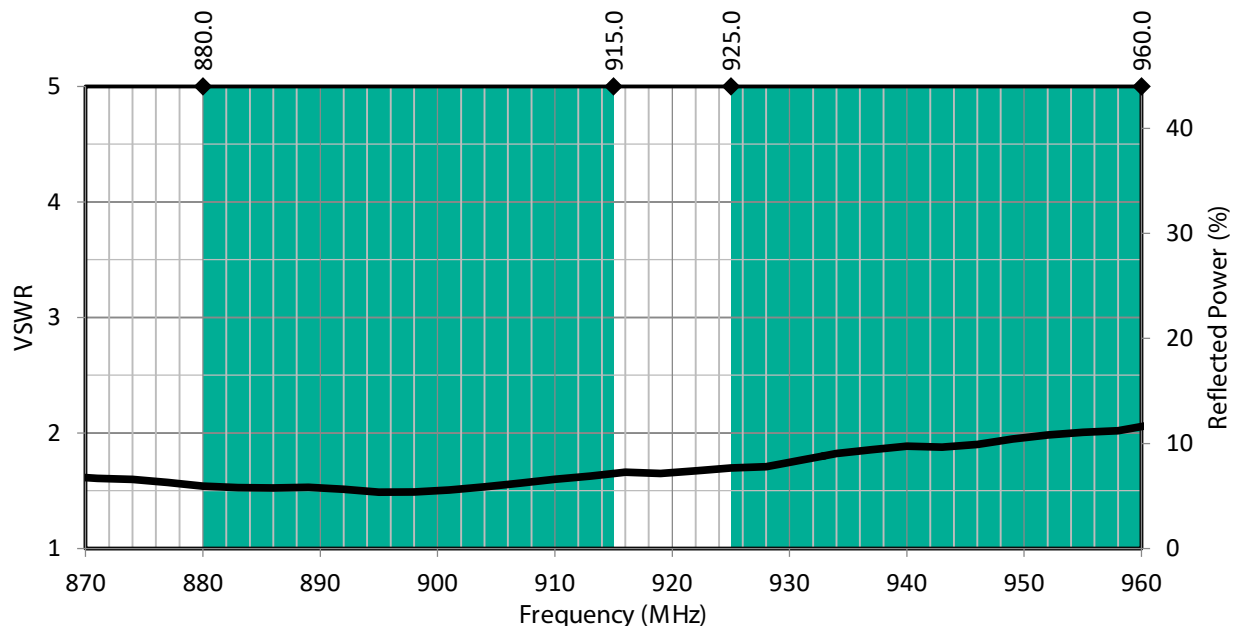

Figure 1: PW LTE Band 8 Antenna VSWR with Band 8 Uplink/Downlink Highlights

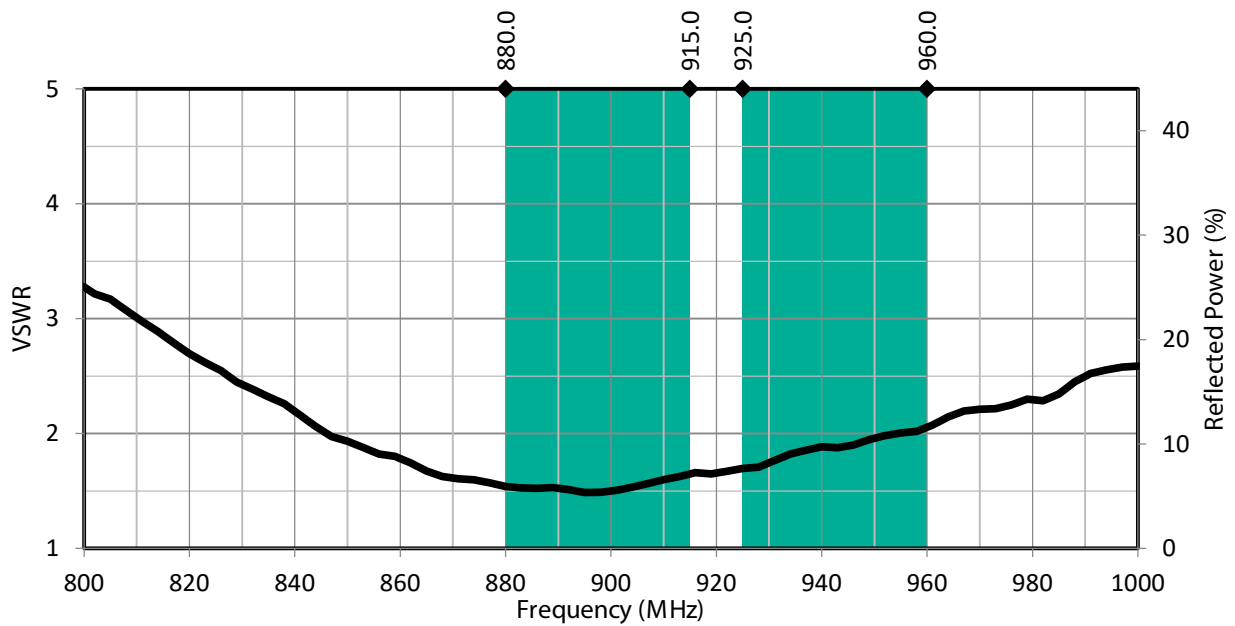

Figure 2: PW LTE Band 8 Antenna Full Bandwidth VSWR

RETURN LOSS

Return loss (Figure 3), represents the loss in power at the antenna due to reflected signals. Like VSWR, a lower return loss value indicates better antenna performance at a given frequency.

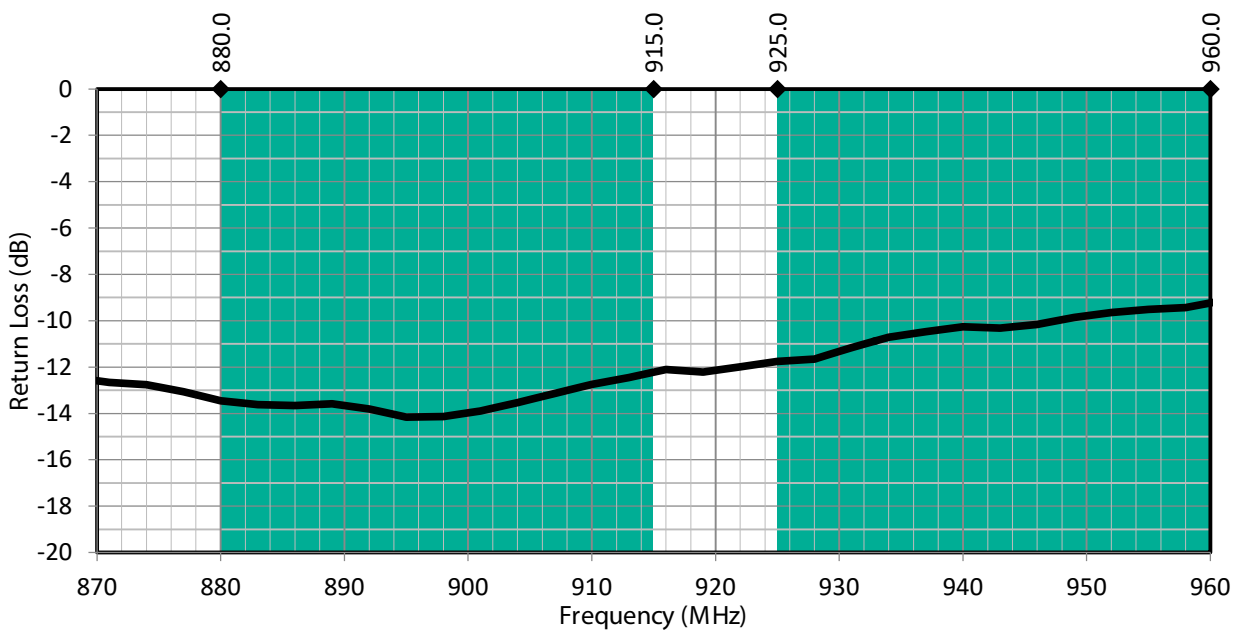

Figure 3: PW LTE Band 8 Antenna Return Loss with Band 8 Uplink/Downlink Highlights

PEAK GAIN

The peak gain across the antenna bandwidth is shown in Figure 4. Peak gain represents the maximum antenna input power concentration across 3-dimensional space, and therefore peak performance, at a given frequency, but does not consider any directionality in the gain pattern.

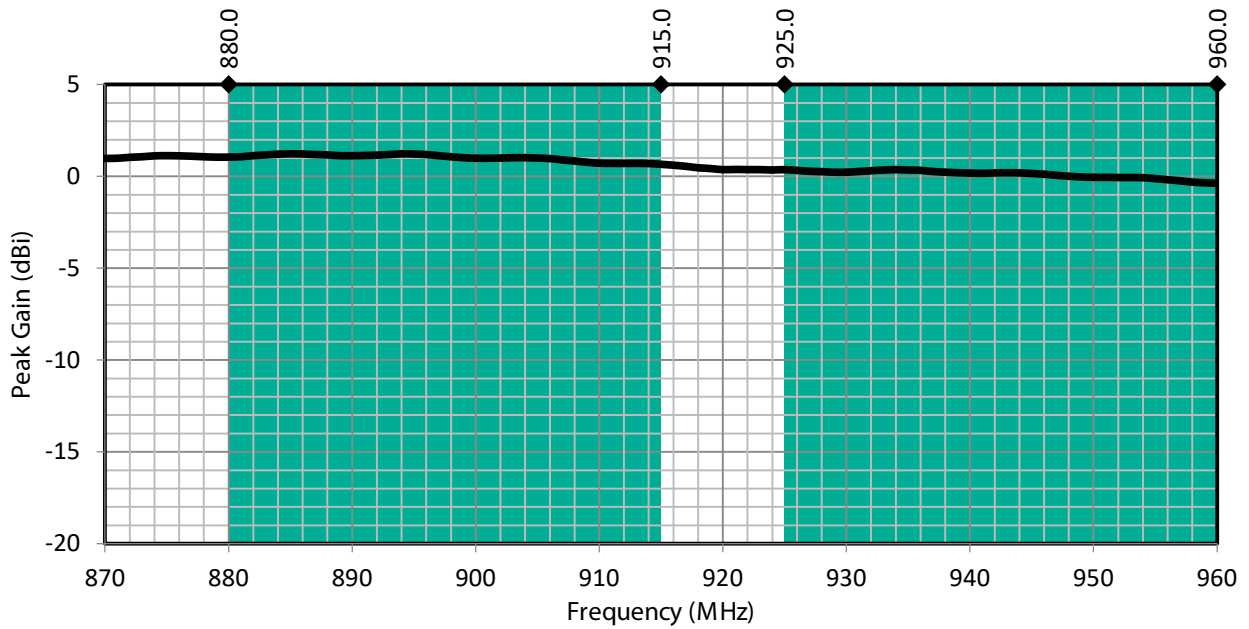

Figure 4: PW LTE Band 8 Antenna Peak Gain with Band 8 Uplink/Downlink Highlights

AVERAGE GAIN

Average gain (Figure 5), is the average of all antenna gain in 3-dimensional space at each frequency, providing an indication of overall performance without expressing antenna directionality.

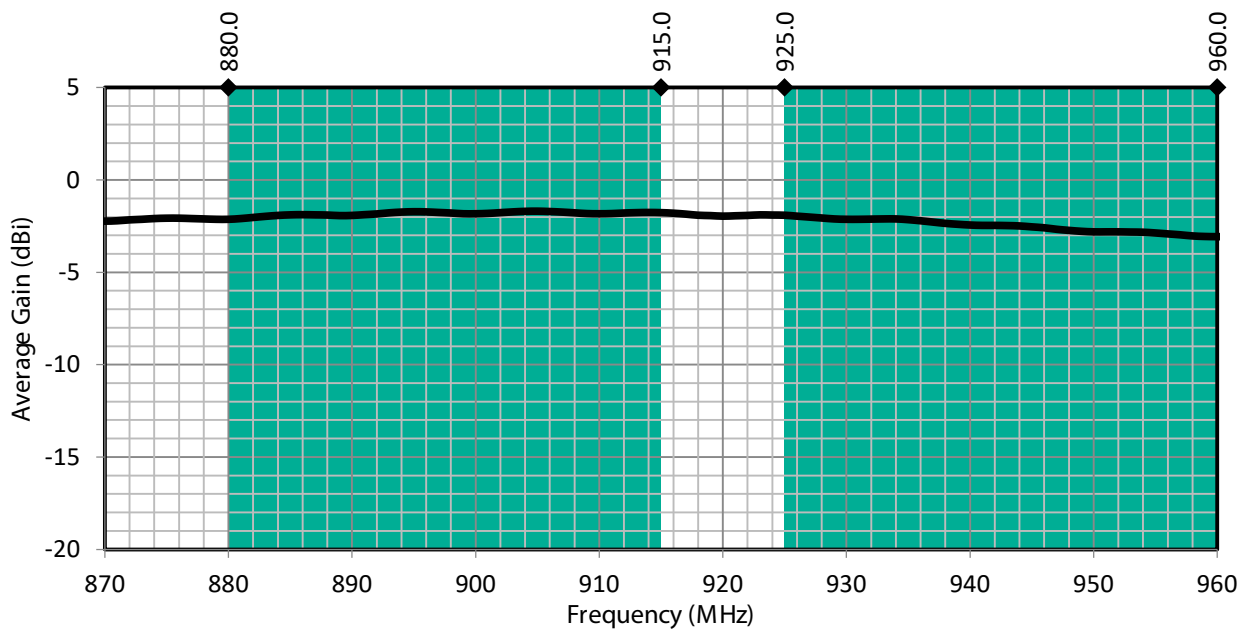

Figure 5: PW LTE Band 8 Antenna Average Gain with Band 8 Uplink/Downlink Highlights

RADIATION EFFICIENCY

Radiation efficiency (Figure 6), shows the ratio of power delivered to the antenna relative to the power radiated at the antenna, expressed as a percentage, where a higher percentage indicates better performance at a given frequency.

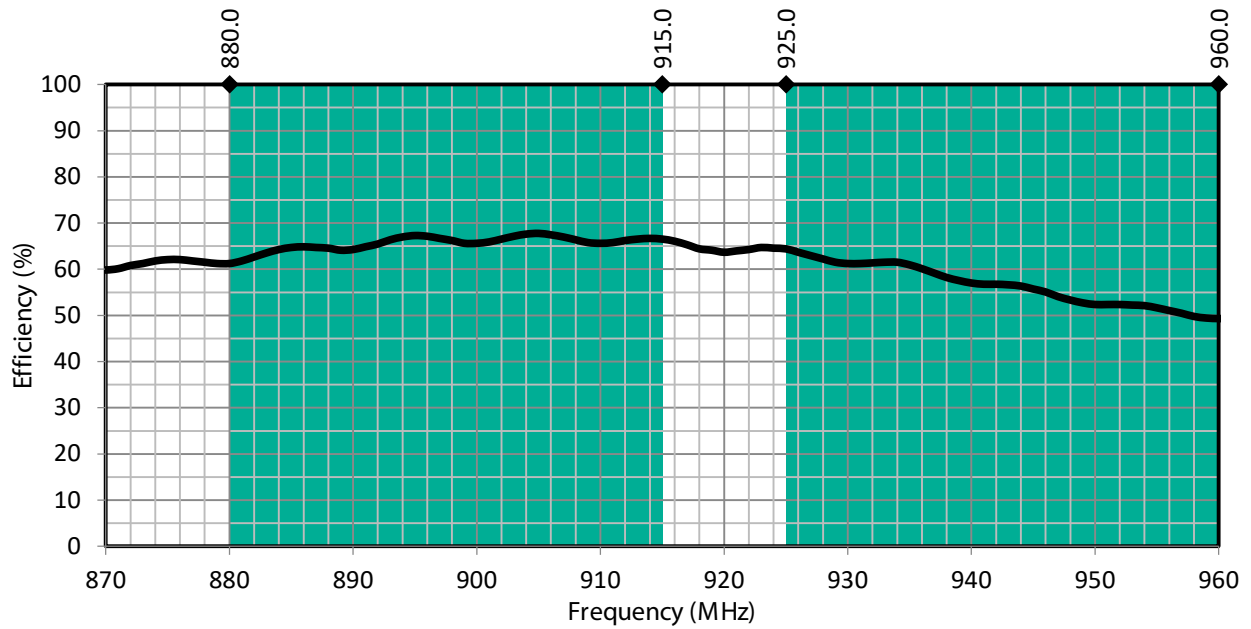

Figure 6: PW LTE Band 8 Antenna Radiation Efficiency with Band 8 Uplink/Downlink Highlights

PRODUCT DIMENSIONS

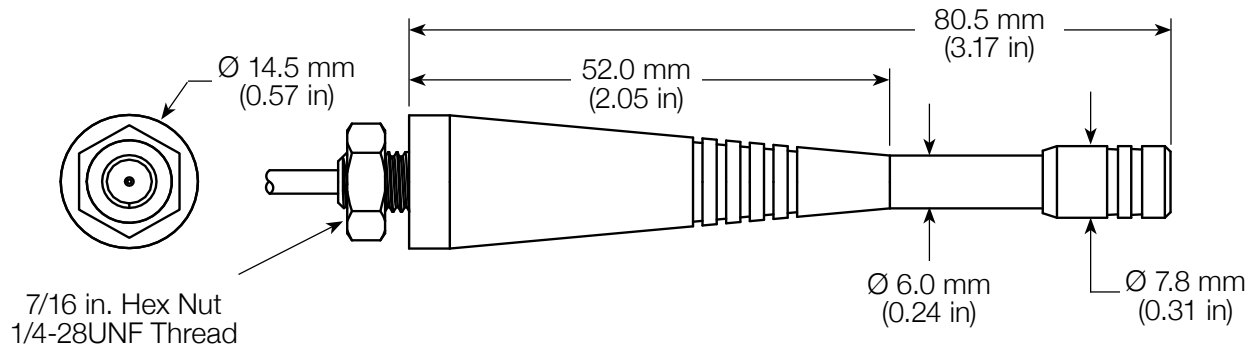

Figure 7: PW LTE Band 8 Antenna Dimensions

ANTENNA MOUNTING

The antenna is attached by placing its cable and base through a 6.35 mm (0.25 in) hole in the product enclosure and securing it with the included nut or by threading it into a PEM-style insert (not included).

The straight-cut RG-174 coax cable option allows the attachment of a 50-ohm RF connector or allows the cable to be soldered directly to a PCB, eliminating the need for a connector. The connectorized option provides a 1.32 mm coax cable terminated with an MHF1/U.FL-compatible plug (female socket) for simplified manufacturing or for applications requiring the ability to disconnect the antenna. For further discussion and guidance on the importance of the ground plane counterpoise, please refer to Linx Application Note, AN-00501: Understanding Antenna Specifications and Operation.

COUNTERPOISE

Quarter-wave or monopole antennas require an associated ground plane counterpoise for proper operation. The size and location of the ground plate relative to the antenna will affect the overall performance of the antenna in the final design. When used in conjunction with a ground plane smaller than that used to tune the antenna, the center frequency typically will shift higher in frequency and the bandwidth will decrease. The proximity of other circuit elements and packaging near the antenna will also affect the final performance.

For further discussion and guidance on the importance of the ground plane counterpoise, please refer to Linx Application Note, AN-00501: Understanding Antenna Specifications and Operation.

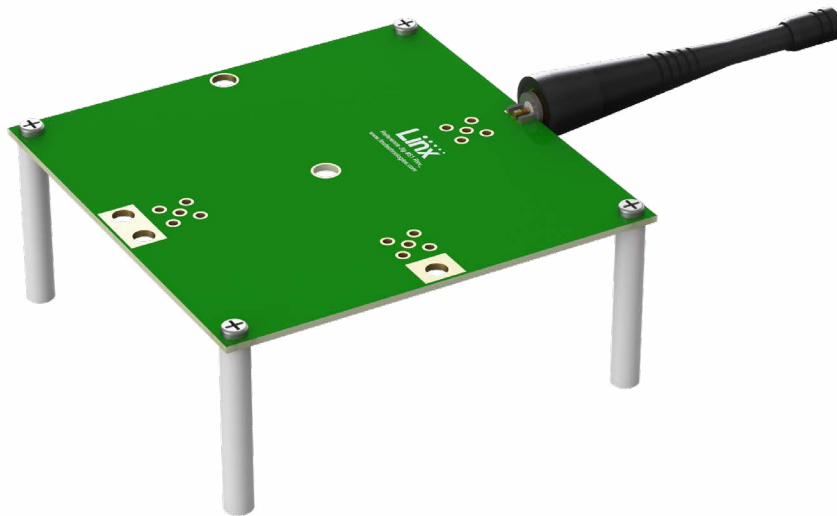
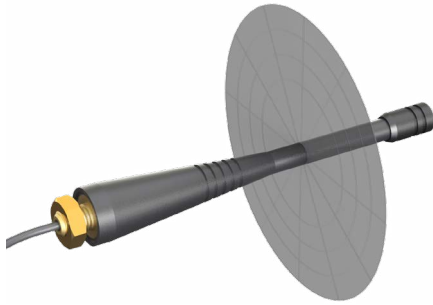

Figure 8: PW LTE Band 8 Antenna Shown On Edge of Evaluation Board

RADIATION PATTERNS

Radiation patterns provide information about the directionality and 3-dimensional gain performance of the antenna by plotting gain at specific frequencies in three orthogonal planes. Antenna radiation patterns (Figure 9), are shown using polar plots covering 360 degrees. The antenna graphic above the plots provides reference to the plane of the column of plots below it. Note: when viewed with typical PDF viewing software, zooming into radiation patterns is possible to reveal fine detail.



XZ-Plane Gain



YZ-Plane Gain



XY-Plane Gain

880 MHz TO 960 MHz (916 MHz)

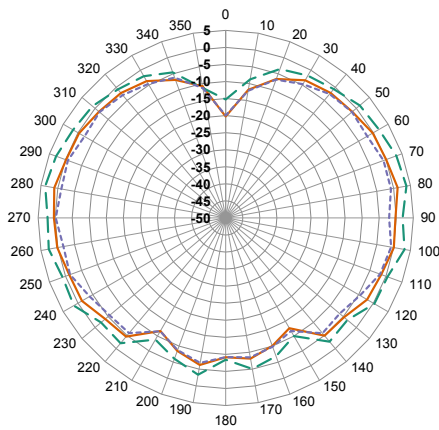

XZ-Plane Gain

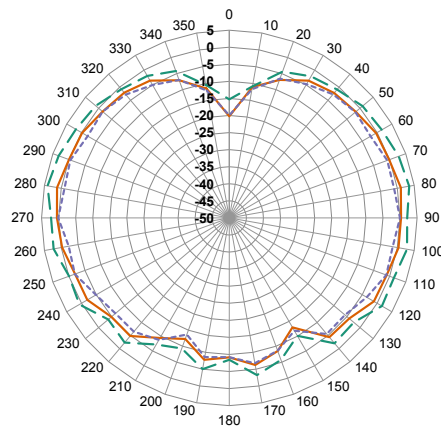

YZ-Plane Gain

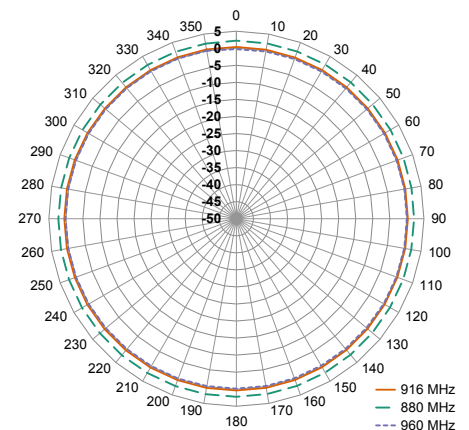

XY-Plane Gain

Figure 9: Radiation Patterns for PW LTE Band 8 Antenna

TE TECHNICAL SUPPORT CENTER

USA:	+1 (800) 522-6752
Canada:	+1 (905) 475-6222
Mexico:	+52 (0) 55-1106-0800
Latin/S. America:	+54 (0) 11-4733-2200
Germany:	+49 (0) 6251-133-1999
UK:	+44 (0) 800-267666
France:	+33 (0) 1-3420-8686
Netherlands:	+31 (0) 73-6246-999
China:	+86 (0) 400-820-6015

te.com

TE Connectivity, TE, TE connectivity (logo), Linx and Linx Technologies are trademarks owned or licensed by the TE Connectivity Ltd. family of companies. All other logos, products and/or company names referred to herein might be trademarks of their respective owners.

The information given herein, including drawings, illustrations and schematics which are intended for illustration purposes only, is believed to be reliable. However, TE Connectivity makes no warranties as to its accuracy or completeness and disclaims any liability in connection with its use. TE Connectivity's obligations shall only be as set forth in TE Connectivity's Standard Terms and Conditions of Sale for this product and in no case will TE Connectivity be liable for any incidental, indirect or consequential damages arising out of the sale, resale, use or misuse of the product. Users of TE Connectivity products should make their own evaluation to determine the suitability of each such product for the specific application.

TE Connectivity warrants to the original end user customer of its products that its products are free from defects in material and workmanship. Subject to conditions and limitations TE Connectivity will, at its option, either repair or replace any part of its products that prove defective because of improper workmanship or materials. This limited warranty is in force for the useful lifetime of the original end product into which the TE Connectivity product is installed. Useful lifetime of the original end product may vary but is not warranted to exceed one (1) year from the original date of the end product purchase.

©2022 TE Connectivity. All Rights Reserved.

11/22 Original