

# TRENDS IN MAGNET WIRE TERMINATION

White Paper

---

## TRENDS IN MAGNET WIRE TERMINATION

Magnet wire is widely used in windings of electric motors, transformers, inductors, generators, electromagnets, coils and other devices. TE Connectivity (TE) offers a wide range of solutions for magnet wire termination, providing significant advantages in terms of cost reduction and improved quality.

### Listening to the Industry

While in the past typical wire range demand was between 0.2 and 2.0 mm diameter [AWG 32 and 12], today's market also requires connections with fine wire (below 0.18 mm diameter, AWG 33) and large wire (above 3.0 mm diameter, AWG 9).

Fine wire is utilized to reduce costs and also to comply with more compact design requirements. Therefore, not only the wire, but also the connection system, must have smaller dimensions to fit in areas where space is a premium.

At the other end of the scale, there is ever-increasing demand for low voltage power across many different applications. Of course, the lower voltages require higher current to deliver the required power, and larger wire is then necessary to carry the higher electrical current. The growth of applications using low voltage power is a steady, undeviating trend: more automation, more cordless devices, more battery packs, more lighting – the list goes on and on.

Another trend that continues to gain momentum, regardless of wire size, is a focus on innovation to effectively manage assembly costs while improving quality and consistency in the connection process. Above all, magnet wire connections and terminations must be reliable. With the high monetary cost of field failures, as well as the possibility of damage to reputation and customer relations, original equipment manufacturers (OEMs) are placing a priority on serving customers with high quality products. Higher quality products and processes can translate into lower costs for the OEMs.

Typical termination technologies used since magnet wire was first introduced are welding and soldering processes. While effective, these thermal processes can be difficult to control. They also require high temperatures that may damage the wire or components, and they require time-consuming mechanical or chemical processes to strip the magnet wire.

Nowadays, to better meet market trends OEMs must investigate different connection technologies that will allow them to achieve savings and that will allow their engineers to design reliable products that perform well.

TE Connectivity offers solutions providing stable electrical connections, achieved through mechanical processes

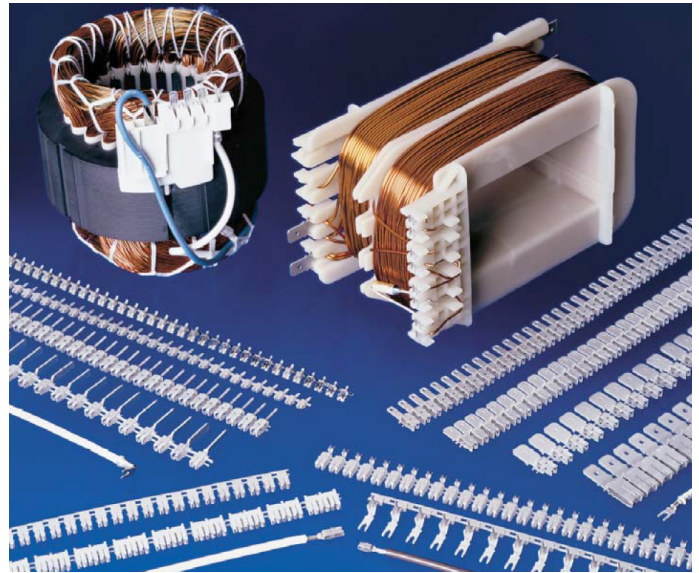

that do not affect physical and chemical properties of the wire. They result from a system approach matching wire, connector application machine, and documentation; are highly repeatable and reliable; and can help to lower applied costs.

### TE Connectivity's IDC and Crimp products

TE Connectivity has been successfully driving superior solutions for magnet wire termination for several decades. TE's MAG-MATE terminals and SIAMEZE terminals are based on insulation displacement connection (IDC) technology, while AMPLIVAR splices and terminals terminate magnet wire through crimp compression. These products eliminate the need for pre-stripping magnet wires.

These connection processes have proven to be an effective alternative to stripping and soldering wire in thousands of applications and, as result, OEMs get efficient and durable products for their manufacturing operations.

TE has long been recognized as a leader in providing the tools required to terminate magnet wire, whether dealing with prototype quantities or high volume production runs. With a full range of tooling from hand tools to high volume, fully automated systems, TE can meet most manufacturing demands worldwide.

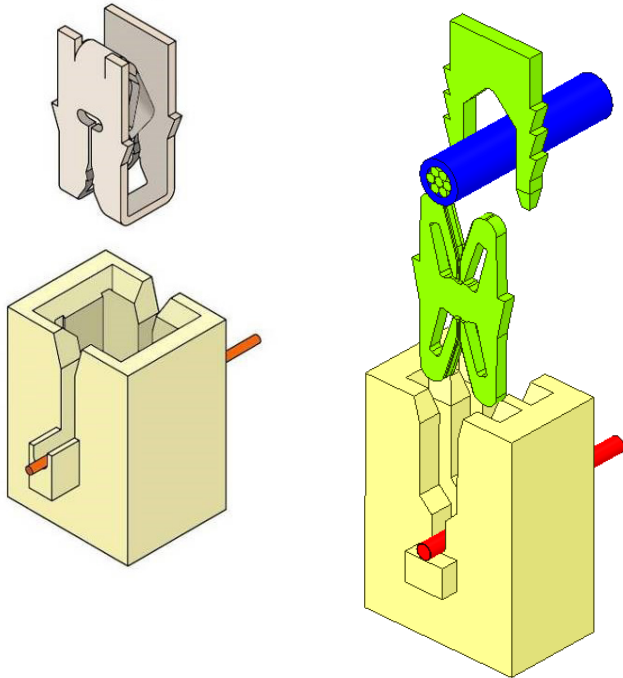

**Fig.1 - MAG-MATE Termination Process**

**Fig.2 - SIAMEZE Termination Process**

## MAG-MATE Terminals and SIAMEZE Terminals

Plastic cavities designed to accept the magnet wires and MAG-MATE terminals or SIAMEZE terminals are designed into the assembly. They may be molded as a part of a coil bobbin or attached to a lamination stack in the area of the magnet wire. Each cavity is a rectangular box with two narrow slots on opposing walls and a plastic post or anvil extending upward from the bottom surface –see Fig. 1 and Fig. 2.

During or after winding the coils, the magnet wire is placed across the plastic cavities and into the slots. Unravelling is prevented by a slight friction fit or suitable bend. Upon completion of the above operation, a MAG-MATE contact or SIAMEZE contact is positioned over the cavity and inserted. The plastic anvil, extending from the base of the cavity, supports the magnet wire, preventing it from being dragged down when the MAG-MATE contact or SIAMEZE contact is inserted. After insertion the terminal is secured in the plastic cavity by locking bars. Mechanical disturbance of the contact interface is eliminated by the combination of opposing cavity and terminal slots. Excess magnet wire is trimmed flush with the outside of the plastic cavity by a shear blade traveling with the terminal insertion ram, and can be tucked inside the cavity, if required.

This is accomplished by cutting the wire off before the terminal is seated which allows the terminal to drag the severed tails into the pocket inside the cavity.

See Fig.3 for the MAG-MATE termination process and Fig.4 for the SIAMEZE termination process

During insertion, the insulation displacing slots of the terminals strip the film insulation from the wire, producing a stable electrical termination. During the process, the wiping action between the wire and the terminal removes all oxides or other contaminants present on both the conductor and the terminal slot walls producing a clean, metal-to-metal interface and stable, gas-tight electrical termination.

The large areas of contact between the wire and the slot walls ensure reliable conduction of high current. Residual spring energy in the terminal causes the side walls of each slot to function as opposing cantilever beams. The constant pressure results in an intimate contact, providing a reliable long-term connection (Fig. 5).

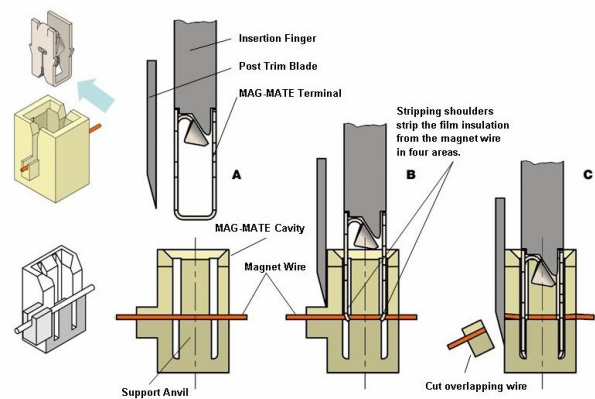

**Fig.3 - MAG-MATE Termination Process**

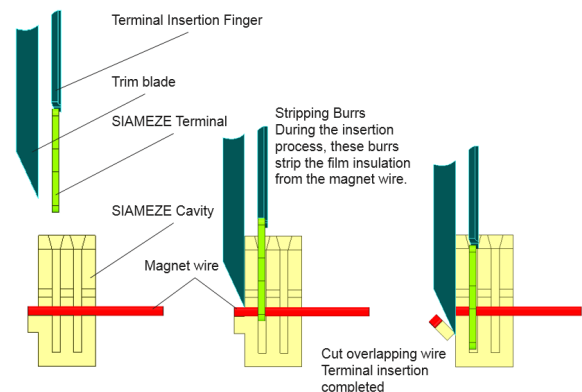

**Fig.4 - SIAMEZE Termination Process**

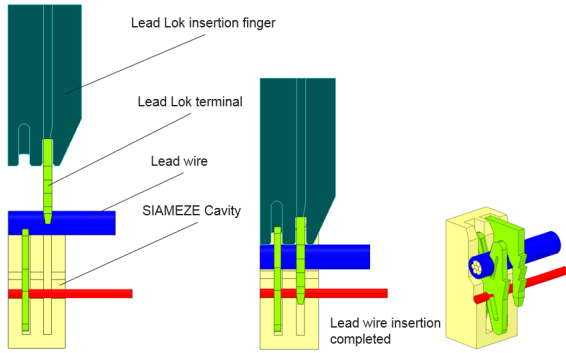

**Fig.4 - SIAMEZE Termination Process (Continued)**

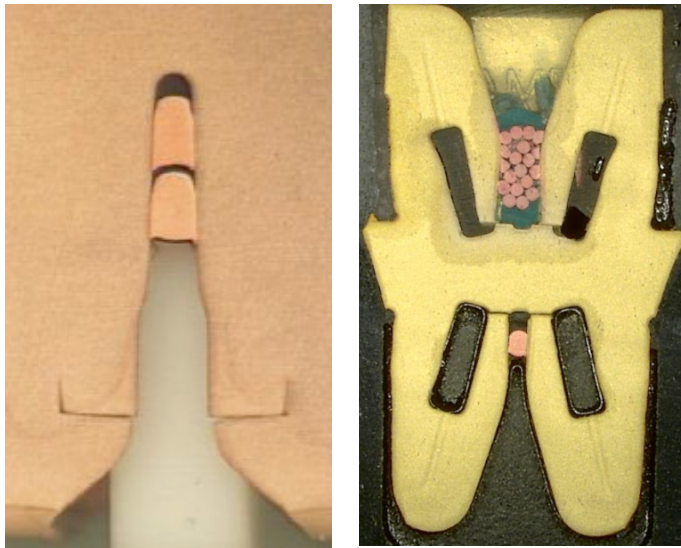

**Fig.5**

Left: MAG-MATE terminal with magnet wires inserted

Right: SIAMEZE terminal with magnet wire and lead wires inserted

There is the possibility to terminate up to two wires, with same diameter, in the same slot.

### AMPLIVAR Splices and Terminals

AMPLIVAR splices and terminals are specifically designed to terminate magnet wire to itself or in combination with stranded solid or stranded lead wire (Fig. 6).

In one-step operation, the magnet wire is automatically multiple ring stripped of its insulation as it is forced into the serrations during the precisely controlled crimp. The resulting termination produces a high tensile strength, air sealed connection that is as resistant to corrosion as the insulated conductor.

AMPLIVAR terminals and splices have machined, sharp edged serrations inside the crimp barrels. These precision serrations pierce the insulating layer of magnet wire in a manner that provides large contact area. As many as 3 magnet wires can be terminated, simultaneously in one splice (Fig.7).

Depending on specific applications, AMPLIVAR splices are available in 5, 7 and 9 serration versions for terminations in the 100-22000 CMA range.

The crimping of AMPLIVAR splices and terminals is done by semi-automatic crimping machines for high output per hour production rates.

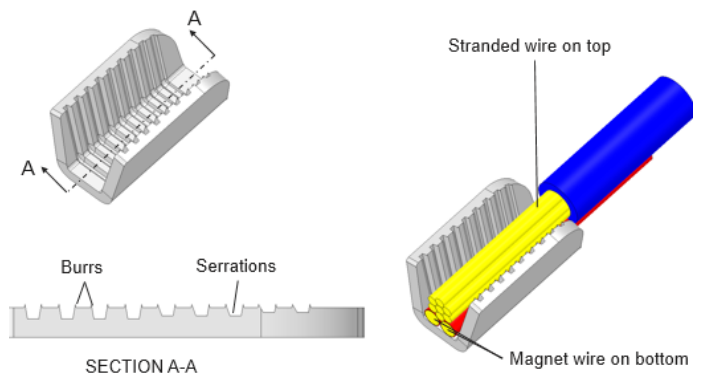

**Fig.6 - AMPLIVAR Termination Process**

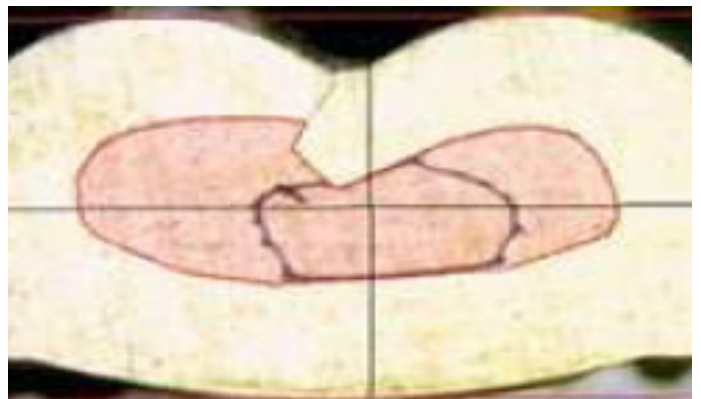

**Fig.7 - Up to 3 magnet wires can be terminated**

## Typical Interface

MAG-MATE terminals, SIAMEZE terminals and AMPLIVAR terminals and splices offer the following typical interface designs to mate with relevant counterparts. Each connection can be customized to specific customer request.

INTERFACE	MAG-MATE	SIAMEZE	AMPLIVAR
RAST 2.5 - RAST 5	✓	-	-
FASTON	✓	✓	✓
MATE-N-LOK	✓	✓	-
PCB	✓	✓	-
Press Fit / Soldering	✓	✓	-
Lead Wire	✓	✓	✓
Ring Tongue	-	-	✓

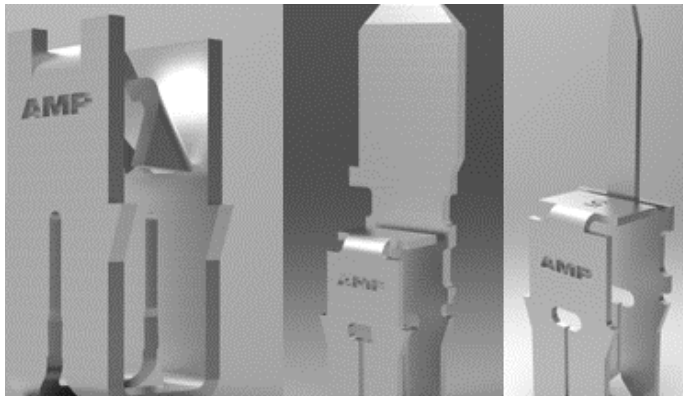

Fig.8 - MAG-MATE terminal examples

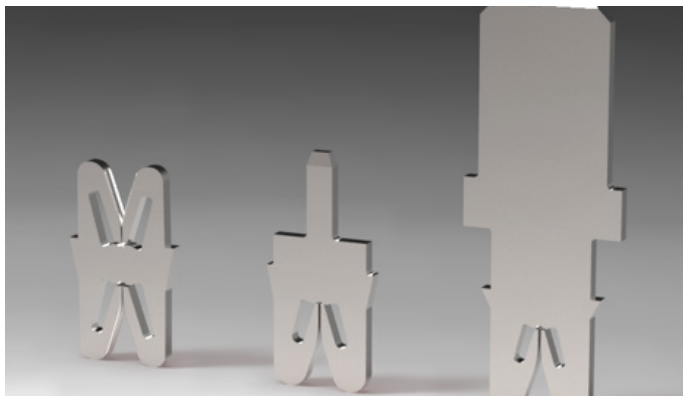

Fig.9 - SIAMEZE terminal examples

## Aluminum Magnet Wire

The switch from copper to aluminum magnet wire on a wide range of applications is today on the agenda of many manufacturers and the demand is increasing.

Just considering the base material, we see 40% lower costs for achieving equal electrical conductivity .

**NORMALIZED RAW MATERIAL EQUAL ELECTRICAL CONDUCTIVITY COST INDEX (%)**  
3 YEARS AVG (2014-2016)

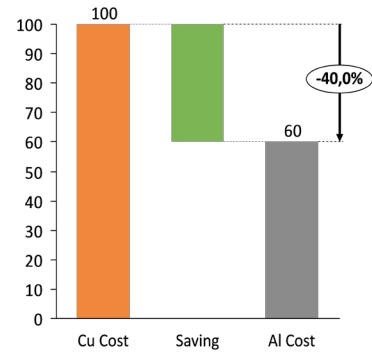

Fig.10

Actual savings vary depending on final product specification and efficiency requirements. If we consider a simple coil made by a plastic bobbin and wire winding, aluminum wire usage will have significant impact, providing high savings on final cost. On a more complex unit, like a fully assembled electrical motor, given current prices, it is possible potentially to reduce cost around 5%.

But there are other advantages to aluminum:

- Aluminum is 1/3 the weight of copper
- Aluminum provides rapid heat dissipation

## Terminating Aluminum Magnet Wire: Solder Versus IDC/Crimp Technology

Soldering aluminum magnet wire is not a reliable process. There are critical areas that need tight control and that are very expensive. Tenacious aluminum oxide makes most attempts to solder using conventional methods difficult. Flux must be used because of the rapid formation of this oxide layer, which is difficult to remove and prevents the solder from wetting the aluminum. Still, the termination technology needs to be fast, efficient, durable and repeatable; soldering or sonic welding are excluded from this requirements list.

MAG-MATE terminals and AMPLIVAR terminals and splices offer the market the advantage of terminating the aluminum magnet wire with a reliable, repeatable process.

The termination of aluminum magnet wire has presented unique challenges for IDC technology. Environmental and mechanical stresses will cause aluminum to experience creep and stress relaxation to a much higher degree than copper. Magnet wire manufacturers have been able to minimize

the creep and stress relaxation characteristics by alloying aluminum magnet wire with iron, but at a higher cost than traditional aluminum wire. Instead, the MAG-MATE IDC termination can be designed to compensate for the material properties of aluminum without impacting the aluminum alloy price, the wire weight – or the termination quality itself.

TE has conducted studies to verify the factors that result in long-term successful IDC termination of aluminum magnet wire.

These studies incorporated environmental and mechanical stresses and evaluated the effects of:

- Wire position within IDC slot
- IDC slot compliance
- Terminal plating materials
- Strain relief features

The tests showed a very stable performance of MAG-MATE terminals on aluminum magnet wire as long as manufacturers take certain precautions during the termination process. To ensure a successful termination on aluminum wire, the manufacturer:

- Must not over-insert the wire into the IDC slots.
- Must incorporate strain relief features in the plastic housing.

In order to ensure that the termination process leaves the wire in a compliant region of the connector slot, the TE engineering team specifies an optimum insertion depth for an application (Fig. 11).

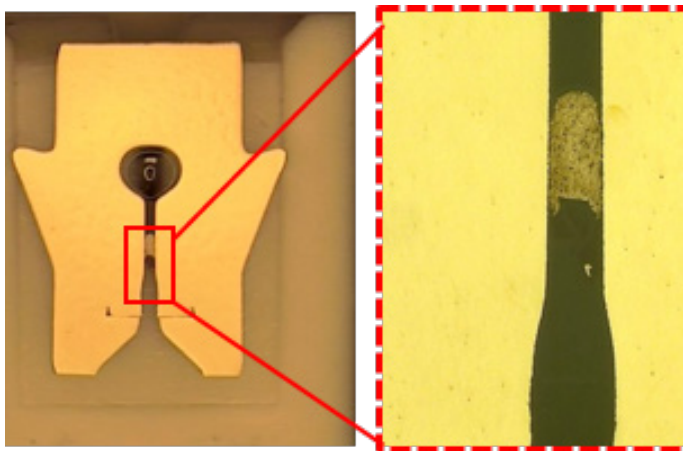

Fig.11 – optimum insertion depth for an application

In addition to that, a strain relief mechanism is required. However, tests have shown that the interference fit between magnet wire and plastic cavity slot can provide an adequate solution.

For AMPLIVAR terminals and splices, aluminum or copper magnet wire or a combination of both can be terminated (Fig.12). When required, aluminum or copper magnet wire can be combined with standard, pre-stripped solid or stranded lead wire.

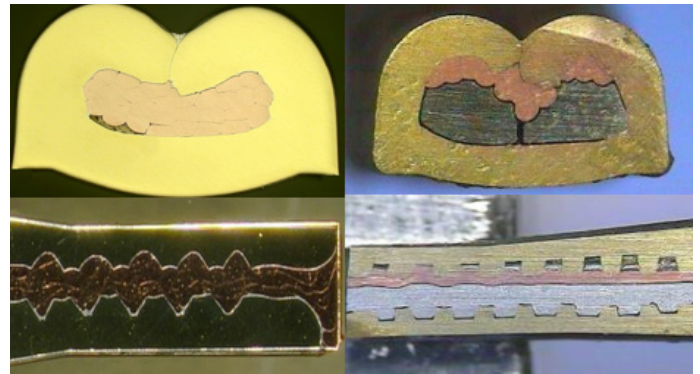

Fig.12

## Application Tooling

More detailed information for terminating MAG-MATE, SIAMEZE and AMPLIVAR can be found at [www.tooling.te.com](http://www.tooling.te.com).

## Conclusions

Utilizing IDC and crimp technologies to terminate magnet wire can offer tangible advantages that cannot be met by standard soldering / welding process:

- IDC and crimp processes eliminate cold solder joints, weld burns and wire embrittlement usually connected with thermal-type terminations.
- Low wire consumption and the elimination of rejects caused by solder flux or heat damage.
- No chemicals or safety guarding for high temperatures/fumes.
- IDC and crimp processes ensure connection without compromising electrical and chemical properties of wires.

- More flexibility for connections, as IDC and crimp processes can terminate copper, aluminium, and copper + aluminium wire combinations.
- Enhanced quality -- With TE delivering a full package termination solution: contact + cavity design (where applicable) + assembly machine + documentation, TE offers full control of the connection.
- Controlled termination for maximum reliability.
- With IDC and crimp termination, aluminum wire can be used for coils and windings -- an equivalent aluminum motor reduces cost around 5 %.

Customers are welcome to contact TE for support.

Many and different services are offered:

- Product development and maintenance for local and global markets, using Six Sigma tools.

- Early involvement and joint development with local and global customers in the design cycle.
- World class test and failure analysis laboratories with CNAS, UL and VDE Certifications.
- Simulation capability includes structural, electrical and thermal.
- Tooling selection / development for your requirements; TE will setup, certify and maintain tooling on site or recommend our factory-level service.

Based on extensive experience in interconnection technology, TE can optimally apply the principal benefits of IDC / crimp technology to magnet wire termination, potentially simplifying design activities, accelerating production processes, improving quality and, ultimately, enhancing profitability.

## te.com

FASTON, MATE-N-LOK, MAG-MATE, SIAMEZE, AMPLIVAR, AMP, TE Connectivity, TE Connectivity (logo), and Every Connection Counts are trademarks of the TE Connectivity Ltd. family of companies. All other logos, products and/or company names referred to herein might be trademarks of their respective owners.

The information given herein, including drawings, illustrations and schematics which are intended for illustration purposes only, is believed to be reliable. However, TE Connectivity makes no warranties as to its accuracy or completeness and disclaims any liability in connection with its use. TE Connectivity's obligations shall only be as set forth in TE Connectivity's Standard Terms and Conditions of Sale for this product and in no case will TE Connectivity be liable for any incidental, indirect or consequential damages arising out of the sale, resale, use or misuse of the product. Users of TE Connectivity products should make their own evaluation to determine the suitability of each such product for the specific application.

Copyright 2017 TE Connectivity Corporation. All Rights Reserved.

1-1773910-9 02/17 Original