



SEACON MSS Metal Shell Series Electrical Dry-Mate Connectors

MSS (Metal Shell Series) Electrical Dry-Mate Connectors Offer Rugged and Versatile Connectivity Solutions

SEACON MSS (Metal Shell Series) Electrical Dry-Mate Connectors

Robust and Versatile Connectivity Solutions for Harsh Environments

KEY FEATURES

STANDARD

- Type 316 stainless steel
- 8 shell sizes
- Up to 156 contacts
- Up to 20,000 psig (approx. 45,000ft / 13,700m) with standard materials
- 600 volt standard ratings. Please contact TE for higher voltage requirements
- Up to 300 amps
- Typical uses: Drilling systems, umbilical links, submarines, Remotely Operated Vehicles (ROV's), tow cables

OPTIONS

- Different material options are available - please contact TE
- Glass to metal sealed inserts
- Pressure Balanced Oil Filled (PBOF)
- Test port versions available to meet American Petroleum Institute (API) requirements
- Fiber optic versions
- Cable to connector terminations including wye and multiple cable breakouts and strength terminations



The Metal Shell Series (MSS) product line of fully ruggedized connectors has been in production since the 1960s and is designed to handle full ocean depth pressure.

Dry-mateable, this series is manufactured from 316 stainless steel as standard, although special to order materials are available, including titanium. The inserts are manufactured from Glass Reinforced Epoxy (GRE) with copper alloy, gold plated contacts, although glass sealed inserts are available for high open face pressure applications.

This connector range is very adaptable to custom strength terminations to cables with steel or synthetic strength members. Standard connectors are designed for use on 1 atmosphere pressure vessels. Contact TE Connectivity (TE) for other applications.

TE Components . . . TE Technology . . . TE Know-how . . .

AMP | AGASTAT | CII | HARTMAN | KILOVAC | MICRODOT | NANONICS | POLAMCO | Raychem

SEACON | Rochester | DEUTSCH

Empower Engineers to Solve Problems, Moving the World Forward.



APPLICATION

- Drilling Systems
- Umbilical Links for ROV's and Submarines
- High Power Motors
- Submersible Pumps
- SEM Control Units
- Cameras and Lamps

SPECIFICATIONS

- **Mated Pressure:** Up to 20,000 psi mated and potted for standard non-PBOF. 5,000 psi if not potted. Up to 7,500 psi mated and potted for standard PBOF. 2,500 psi if not potted.
- **Open Face Pressure:** Pressure ratings can be accomplished with most of this range, but the connectors are not open face rated as standard. Please contact TE for further information.
- **Voltage Rating:** 600 VDC as standard although higher voltage versions are available. Please refer to the contact configuration pages 14-17.
- **Current Rating:** Up to 200 amps dependent on contact size and cable (see below for electrical contact sizes)

MATERIALS

- **Bulkhead Body (BCR/FCR):** 316L Stainless Steel (or equivalent).
- **CCP Body:** 316L Stainless Steel (or equivalent).
- **Contact Inserts:** Glass filled epoxy per MIL-M-24325.
- **Electrical Inserts:** Copper alloy gold plated per MIL-G-45204.
- **Engaging Nut:** CA630 (or equivalent).
- **O-Ring:** Nitrile (formerly known as Buna N).

TESTING

The MSS range of connectors have been subjected to the following testing:-

- **Insulation Resistance:** 15 Gohms @ 500 VDC.
- **Dielectric Withstanding:** 1,200 VAC with a maximum leakage of .1 mA.

ENVIRONMENTAL TESTING CAPABILITY

- Four hydrostatic pressure vessels capable of testing underwater components to 1,000 psi, 10,000 psi, 18,000 psi, and 20,000 psi.
- Connectors can be tested mated, or in an open face condition and tests can be performed in water or oil.
- Electrical properties can often be monitored during the pressure cycling process.

Please contact TE for further information.



American Petroleum Institute (API) Compliant Connectors

For decades, SEACON's highly successful Metal Shell Series (MSS) connector range has offered high contact density and a variety of power and signal configurations to meet customer underwater power and data requirements. Adapted from that series, the SEACON API connector series is compliant with American Petroleum Institute (API) specifications 16D (Control Systems for Drilling Well Control Equipment and Control Systems for Diverter Equipment) and 17E (specification for Subsea Umbilicals).



KEY FEATURES

- Bulkhead connectors are compliant with appropriate section of API 16D specifications
- Cabled connectors and assemblies are compliant with appropriate section of API 16D and API 17E specifications
- Redundant sealing at all pressure barrier interfaces
- Multiple test ports for in-the-field o-ring testing and verification
- Boot sealing in cabled connectors and assemblies in event of flooded cable conditions
- Electrical, optical and hybrid connectors configurable in 8 shell sizes
- Factory Acceptance Testing (FAT) includes both mated and open-face pressure testing
- Custom interfaces available
- Flanged Connector [bulkhead] Receptacle connectors have inboard water-blocking boots over the electrical termination to help eliminate risk of failure in a flooded housing scenario
- Pressure Balanced Oil Filled (PBOF) cables operate fully in the event of breached hose/water ingress with full-pressure water-blocking on the solder cup side of the connectors
- Oil-filled cable connectors options available without valves help eliminate a direct path for water to reach the face of the bulkhead connector in case of hose flooding

MATERIALS & RATINGS

- 316 Stainless Steel with GRE inserts and copper-alloy, gold-plated contacts. Alternate materials including Titanium shells and Glass to Metal inserts are also available
- Voltage rating of 600 VDC
- Pressure rating of up to 10,000 psi (approx. 22,500ft /7,000m)

CONFIGURATIONS

BULKHEAD

- MSSK-8#16-FCR-HP
- MSSK/MINK(SP)-6#16-FCR
- MSSK/MSSG-4(1#16/3#14)-FCR
- MSSK-16#20AWG-CCR PBOF
- MSSM-4FO/8#16-FCR
- MSSM-4#8-FCR-SP
- MSSP-48#16AWG-FCR-GS
- MSSQ-8FO/4#10-FCR

CABLE CONNECTOR

- MSSK-8#16-CCP-V3-PBOF
- MSSK-6#16-CCP R/A
- MSSK-4(1#16/3#14)-CCP
- MSSK-16#20AWG-CCP PBOF
- MSSM-4FO/8#16-CCP
- MSSM-4#8-CCP-SP
- MSSM-4FO(MM)-CCP-SP
- MSSP-48#16AWG-CCP-RA PBOF
- MSSQ-8FO/4#10-CCP

The above configurations have test port features allowing integration into equipment/systems requiring compliance to API standards.

APPLICATIONS

- Blowout Preventer
- Riser Monitoring
- Drilling Control Systems



MSS Connectors

Ordering Information

Family Designator

MSS

Shell Size

G
K
L
M
O
P
Q
S

Number of Contacts Total

Connector Type

BCR Bulkhead Connector Receptacle
FCR Flange Connector Receptacle
CCP Cable Connector Plug
DSR Dummy Sealing Receptacle
DSP Dummy Sealing Plug

Pressure Balanced Oil Filled (Optional)

PBOF

Right Angle

RA

MSSX - X - XXX - XXXX - XX

Electrical Contact Sizes

The ampacity is computed at temperature range of +30°F to +70°F. Above 70°F the ampacity drops.

Current ratings can be impacted by cable selection.

Contact AWG	Diameter (In)	Ampacity (Amps)
#28 AWG	0.015	0.5
#22 AWG	0.031	2.5
#20 AWG	0.040	4
#16 AWG	0.062	13
#14 AWG	0.093	16
#10 AWG	0.125	23
#8 AWG	0.156	50
#6 AWG	0.218	65
#4 AWG	0.255	90
#1/0 AWG	0.355	200



MSS-BCR

Bulkhead Connector Receptacle

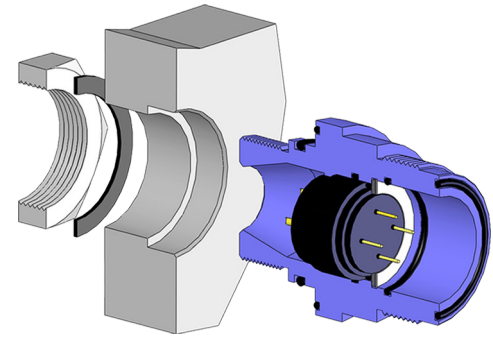
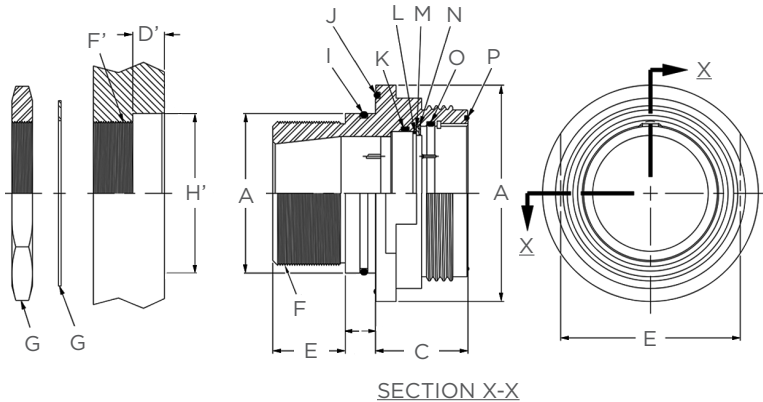

G, K, L, M sizes have round keyway. O, P and Q have square keyway. However, with the Aluminum option all sizes have a square keyway. Refer to page pages 11-16 for contact configurations. G, K, L, M Aluminum connectors will not mate with Stainless Steel connectors.

	A	B	C	D	E	F	G	H	I	J	K	L
Shell Diameter Size (In)	Wrench Flats (In)	Height (In)	Shoulder (In)	Thread Length (In)	Thread Size (In)	Hex Nut Across Flats (In)	Diameter Max. (In)	O-Ring	O-Ring	O-Ring	O-Ring	
G	1.37	1.18	1.50	0.37	0.62	3/4-16UNF-2A	1.2 X 0.25	0.810	2-017	2-023	2-016	NONE
K	1.87	1.62	2.00	0.37	1.00	1-14UNS-2A	1.50 X 0.37	1.060	2-21	2-29	2-118	2-18
L	2.12	1.88	2.00	0.37	1.00	1 1/4-2UN-2A	1.75 X 0.25	1.310	2-122	2-131	2-122	2-022
M	2.75	2.25	2.25	0.50	0.87	1 3/4-12UN-2A	2.25 X 0.50	1.997	2-224	2-142	2-126	2-123
O	3.50	2.75	2.25	0.50	1.25	2 1/4-12UN-2A	3.00 X 0.50	2.497	2-228	2-234	2-225	2-131
P	3.75	3.00	2.25	0.75	1.50	2 1/2-12UN-2A	3.25 X 0.50	2.747	2-230	2-236	2-227	2-135
Q	4.50	3.62	2.25	0.75	1.75	2 3/4-12UN-2B	3.75 X 0.50	3.122	2-233	2-241	2-230	2-141

Shell Size	M Washer	N Retaining Ring	O O-Ring	P O-Ring	D' Min. (In)	Mounting Dimensions			Part Number
						F' Bored Min. (In)	F' Threaded	H' Bore Diameter (in)	
G	NONE	UR-62	2-016	2-020	0.380	0.750	3/4-16UNF-2B	0.812/0.814	MSSG-X-BCR-XXXX-XX
K	77-1-274	UR-106	2-23-70	2-27-70	0.380	0.995	1-14NS-2B	1.062/1.064	MSSK-X-BCR-XXXX-XX
L	77-1-374	UR-131	2-027	5-320	0.380	1.250	1 1/4-12UN-2B	1.312/1.314	MSSL-X-BCR-XXXX-XX
M	77-1-474	UR-150	2-128	2-132	0.520	1.750	1 3/4-12UN-2B	2.000/2.002	MSSM-X-BCR-XXXX-XX
O	77-1-574	UR-187	2-225	2-140	0.520	2.250	2 1/4-12UN-2B	2.500/2.502	MSSO-X-BCR-XXXX-XX
P	77-1-674	UR-212	2-227	2-144	0.520	2.500	2 1/2-12UN-2B	2.750/2.752	MSSP-X-BCR-XXXX-XX
Q	77-1-774	UR-250	2-230	2-151	0.770	2.750	2 3/4-12UN-2B	3.125/3.127	MSSQ-X-BCR-XXXX-XX

Notes:

- For MSS-S connector details please contact TE.



MSS-FCR

Flange Cable Receptacle

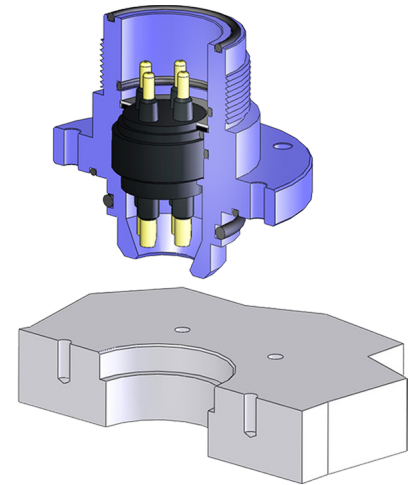
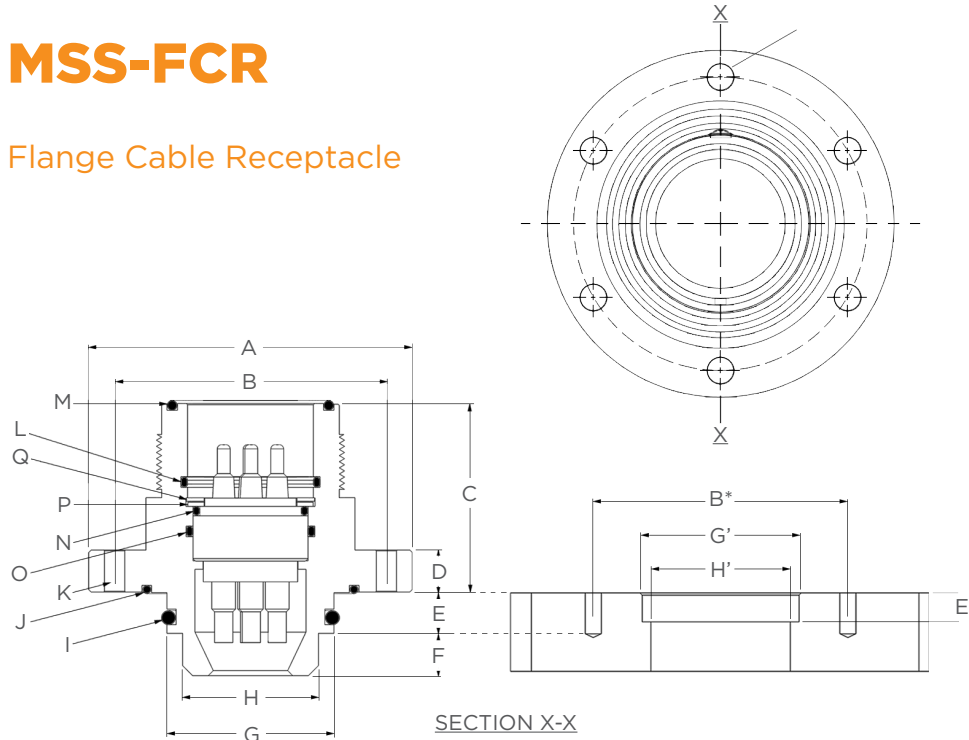

G, K, L, M sizes have round keyway. O, P and Q have square keyway. However, with the Aluminum option all sizes have a square keyway. Refer to page pages 11-16 for contact configurations. G, K, L, M Aluminum connectors will not mate with Stainless Steel connectors.

	A	B	C	D	E	F	G	H	I	J	K	L	M
Shell Size	Diameter (In)	Hole Circle	Height (In)	Height (In)	Height (In)	Height (In)	Diameter Max. (In)	Diameter (In)	O-Ring	O-Ring	Bolt Size	O-Ring	O-Ring
G	2.12	1.812	1.68	0.37	0.37	0.26	0.810	0.68	2-017	2-023	3/16"	2-016	2-020
K	2.62	2.250	2.00	0.37	0.37	0.38	1.060	0.87	2-021	2-029	3/16"	2-23-70	2-27-70
L	3.00	2.500	2.00	0.38	0.37	0.38	1.310	1.12	2-122	2-131	1/4"	2-027	5-320
M	3.87	3.250	2.26	0.51	0.48	0.50	1.997	1.62	2-224	2-142	1/4"	2-128	2-132
O	4.50	3.875	2.26	0.51	0.48	0.50	2.497	2.12	2-228	2-234	3/8"	2-225	2-140
P	4.75	4.125	2.26	0.51	0.48	0.50	2.747	2.37	2-230	2-236	3/8"	2-227	2-144
Q	5.25	4.625	2.26	0.51	0.75	0.74	3.122	2.75	2-233	2-240	3/8"	2-230	2-151

Mounting Dimensions

Shell Size	N O-Ring	O O-Ring	P Washer	Q Retaining Ring	E' Bore Depth Min. (In)	G' Bore Diameter (In)	H' Bore Min. (In)	Part Number
G	NONE	2-016	NONE	UR-62	0.385	0.812/0.814	0.750	MSSG-X-FCR-XXXX-XX
K	2-18	2-118	77-1-274	UR-106	0.385	1.062/1.064	0.890	MSSK-X-FCR-XXXX-XX
L	2-022	2-122	77-1-374	UR-131	0.520	1.312/1.314	1.140	MSSL-X-FCR-XXXX-XX
M	2-123	2-126	77-1-474	UR-150	0.520	2.000/2.002	1.780	MSSM-X-FCR-XXXX-XX
O	2-131	2-225	77-1-574	UR-187	0.520	2.500/2.502	2.140	MSSO-X-FCR-XXXX-XX
P	2-135	2-227	77-1-674	UR-212	0.520	2.750/2.752	2.406	MSSP-X-FCR-XXXX-XX
Q	2-141	2-230	77-1-774	UR-250	0.770	3.125/3.127	2.765	MSSQ-X-FCR-XXXX-XX

Notes:

• For MSS-S connector details please contact TE.

• * 6 holes equally spaced.



MSS-CCP

Cable Connector Plug

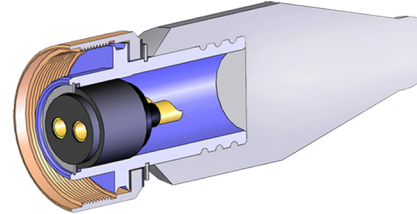
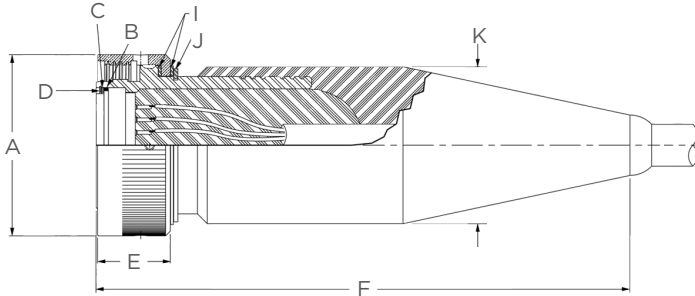

G, K, L, M sizes have round keyway. O, P and Q have square keyway. However, with the Aluminum option all sizes have a square keyway. Refer to page pages 11-16 for contact configurations. G, K, L, M Aluminum connectors will not mate with Stainless Steel connectors.

MSS-CCP-RA

Cable Connector Plug Right Angle

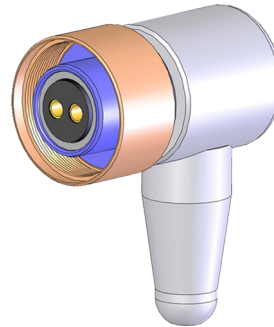
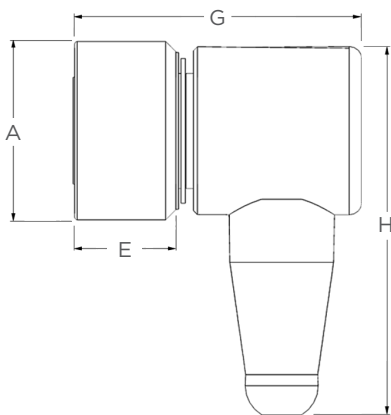

	A	B	C	D	E	F	G	H	I	J	K	
	Shell Diameter	O-Ring	Washer	Retaining Ring	Engaging Nut	Length	Height	Height	Engaging Nut	Retaining Ring	Diameter	Part Number
Size	(In)					(In)	(In)	(In)				
G	1.37	-	-	-	1.09	5.3	3.0	3.5	77-1-148	5100-87	0.87	MSSG-X-CCP-XXXX-XX
K	1.87	2-017	77-1-261	UR-87	1.22	6.0	3.25	3.5	77-1-248	5100-112	1.12	MSSK-X-CCP-XXXX-XX
L	2.12	2-021	77-1-373	UR-112	1.22	6.0	3.25	4.50	77-1-348	5100-137	1.37	MSSL-X-CCP-XXXX-XX
M	2.50	2-024	77-1-473	UR-137	1.87	10.5	4.7	6.7	77-1-448	5100-162	1.62	MSSM-X-CCP-XXXX-XX
O	3.00	2-127	77-1-573	UR-162	1.87	10.5	5.3	7.8	77-1-548	5100-212	2.12	MSSO-X-CCP-XXXX-XX
P	3.25	2-131	77-1-673	UR-187	1.87	10.8	5.3	7.8	77-1-648	5100-237	2.37	MSSP-X-CCP-XXXX-XX
Q	3.87	2-137	14-979	UR-225	1.87	11.5	6.0	9.6	77-1-748	5100-275	2.75	MSSQ-X-CCP-XXXX-XX

Notes:

- MSS-G-CCP body is Glass Reinforced Epoxy. The nut is metal. Connector does not come molded to cable unless specified.
- For MSS-S connector details please contact TE.



MSS-CCR

Cable Connector Receptacle

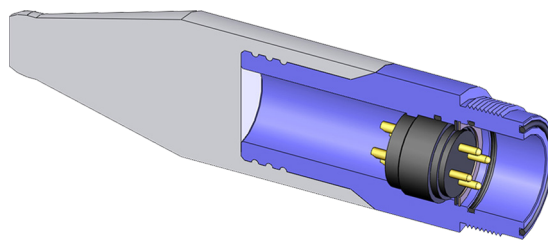
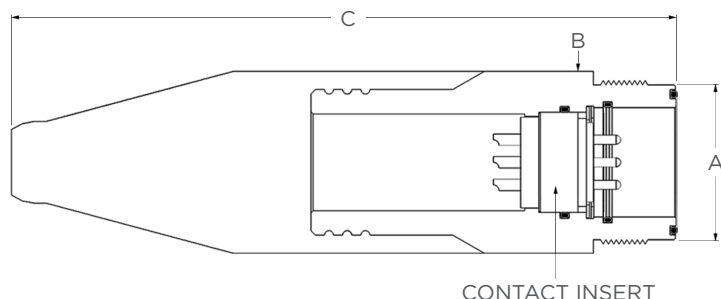

G, K, L, M sizes have round keyway. O, P and Q have square keyway. Refer to pages 11-16 for contact configurations. G, K, L, M Aluminum connectors will not mate with Stainless Steel connectors.

Shell Size	A Diameter (In)	B Wrench Flats	C Length (In)	Part Number
G	1.37	1.118	5.5	MSSG-X-CCR-XXXX-XX
K	1.87	1.62	6.7	MSSK-X-CCR-XXXX-XX
L	2.12	1.87	7.0	MSSL-X-CCR-XXXX-XX
M	2.50	2.25	9.5	MSSM-X-CCR-XXXX-XX
O	3.00	2.75	10.0	MSSO-X-CCR-XXXX-XX
P	3.25	3.00	11.5	MSSP-X-CCR-XXXX-XX
Q	3.87	3.62	12.0	MSSQ-X-CCR-XXXX-XX

MSS-CCP-SC

Cable Connector Plug Stress Core Termination

For termination of cables with stranded wire rope mechanical members located in the center of the cable

The stress core termination shown above can be accomplished in all the MSS Series sizes with the exception of the MSS-G.

This type of termination will develop the full breaking strength of the electro mechanical cable.

Strength is carried through CCP coupling nut and BCR or CCR threads.

Connector bodies do not come molded to cables unless so specified when ordering.

F = Refer to chart on page 8

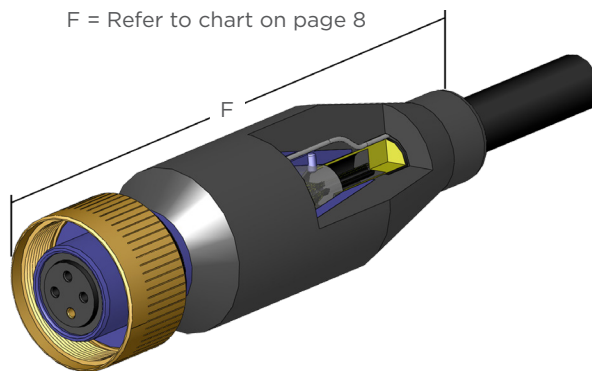

Notes:

- For MSS-S connector details please contact TE.



Typical Stress Core Terminations

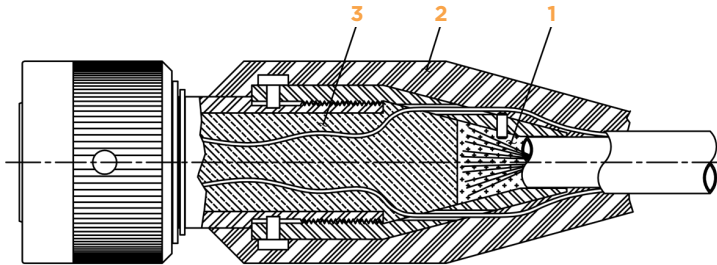

CONCEPTUAL TERMINATION FOR SYNTHETIC FIBER, CENTER CORE

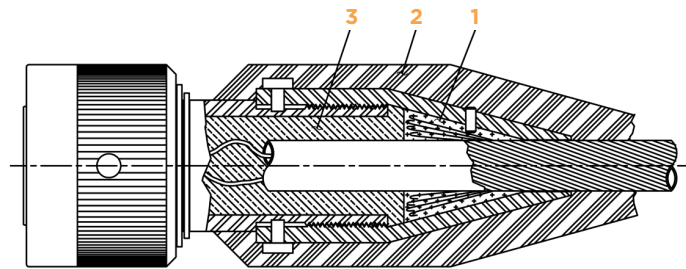

CONCEPTUAL TERMINATION FOR STEEL, DOUBLE ARMOR

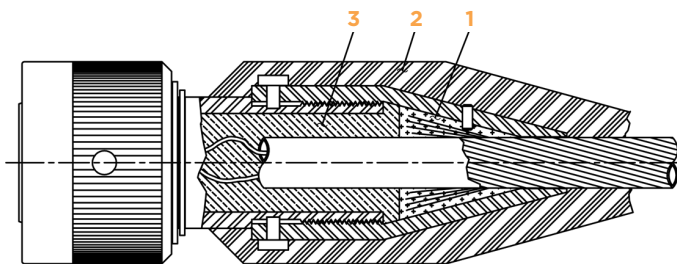

CONCEPTUAL TERMINATION FOR SYNTHETIC FIBER, OUTER BRAID

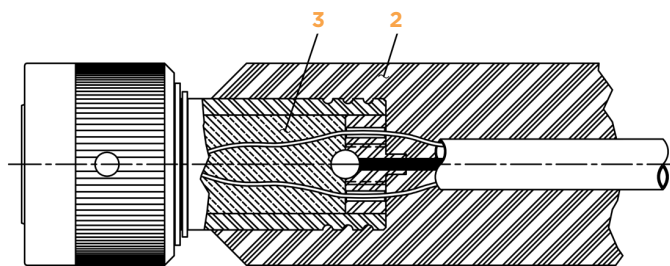

CONCEPTUAL TERMINATION FOR STEEL, CENTER CORE

1 - Polyurethane.

2 - Overmold.

3 - Hard Potting Compound.

Notes:

- The above are typical strain termination solutions. We have facilities to bespoke stress terminations to specific customer cable requirements.



MSS-BCR-PBOF

Bulkhead Connector Receptacle

Specifications

- **BODY MATERIAL:** 316 Stainless Steel.
- **INSERT:** Glass Reinforced Epoxy.
- **CONTACTS:** Brass, gold plated.
- **PRESSURE RATING:** 7,500 psi (2,500 psi or more requires the BCR to be back potted or pressure balanced on solder cup side of insert).

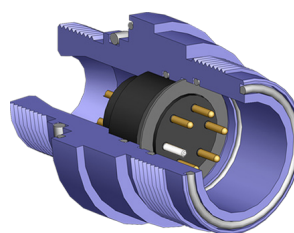
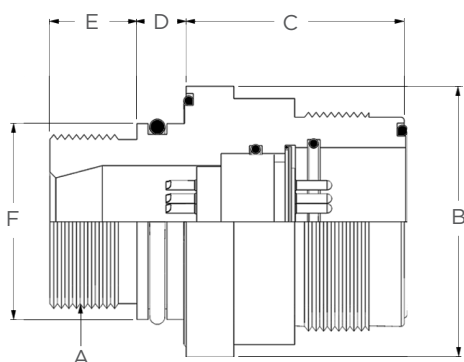

Shell Size	A Thread	B Diameter (In)	C Length (In)	D Length (In)	E Length (In)	F Diameter (In)	Part Number
K	1-1/4NS-2A	1.87	2.0	0.375	1.00	1.060	MSSK-X-BCR-PBOF-XX
L	1-1/4-12 UN-2A	2.12	2.0	0.375	1.00	1.310	MSSL-X-BCR-PBOF-XX
M	1-3/4-12 UN-2A	2.75	2.25	0.500	0.870	1.997	MSSM-X-BCR-PBOF-XX
O	2-1/4-12 UN-2A	3.50	2.25	0.500	1.250	2.497	MSSO-X-BCR-PBOF-XX
P	2-1/2-12 UN-2A	3.75	2.25	0.500	1.500	2.747	MSSP-X-BCR-PBOF-XX
Q	2-3/4-12 UN-2A	4.50	2.25	0.750	1.750	3.122	MSSQ-X-BCR-PBOF-XX

Notes:

- * These parts are standard and require no set-up charge.
- Parts where no asterix appears may require set-up charges and have longer deliveries.
- Refer to pages 11-18 for available contact configurations.



MSS-CCP-PBOF

Cable Connector Plug Pressure Balanced Oil Filled

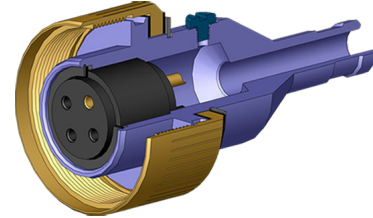
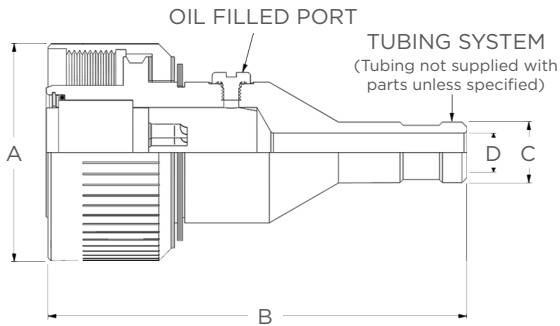

MSS-CCP-PBOF-RA

Cable Connector Plug Pressure Balanced Oil Filled Right Angle

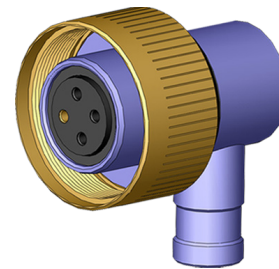
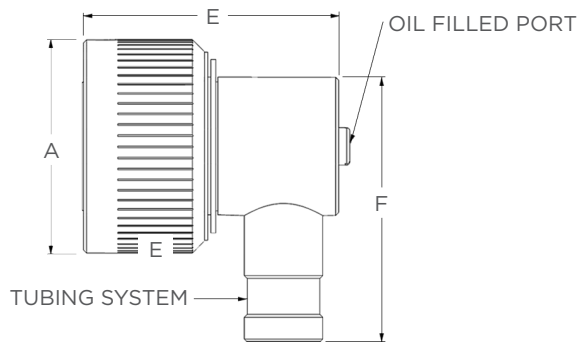

Shell Size	A Diameter (In)	B Length (In)	C Diameter (In)	D Diameter (In)	E Length (In)	F RA Height (In)	Part Number
K	1.87	3.00	0.672	0.48	2.37	2.12	MSSG-X-CCP-PBOF-XX
L	2.12	3.75	0.844	0.62	2.82	2.56	MSSG-X-CCP-PBOF-XX
M	2.50	5.00	0.844	0.62	3.26	3.00	MSSG-X-CCP-PBOF-XX
O	3.00	5.81	1.000	0.62	3.50	3.75	MSSG-X-CCP-PBOF-XX
P	3.25	6.62	1.000	0.82	3.37	3.75	MSSG-X-CCP-PBOF-XX
Q	3.87	7.00	1.250	1.06	4.19	4.12	MSSG-X-CCP-PBOF-XX

Specifications

- **BODY MATERIAL:** 316 Stainless Steel.
- **NUT:** Bronze.
- **INSERT:** Glass Reinforced Epoxy.
- **CONTACTS:** Brass, gold plated.
- **PRESSURE RATING:** 7,500 psi.



MSS-DSR

Dummy Sealing Receptacle

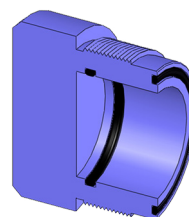
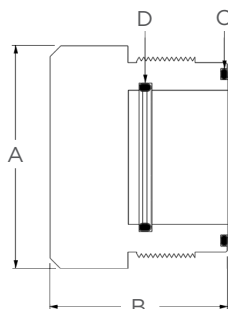

Notes:

- **MATERIAL:** 316 Stainless Steel. Other materials available on request.

MSS-DSP

Dummy Sealing Plug

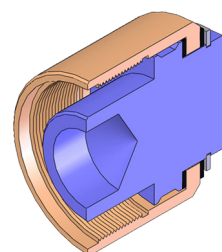
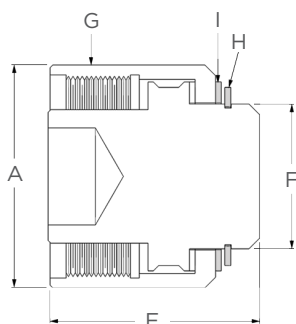

Notes:

- **MATERIAL:** 316 Stainless Steel with a CA630 engaging nut, however the material for the MSSG is GRE (Glass Reinforced Epoxy) with a CA630 engaging nut. Other materials available on request.

Shell Size	A Diameter (In)	B Length (In)	C O-Ring	D O-Ring	E Length (In)	C Diameter (In)	D Engaging Nut	E Retaining Ring	F Washer	Part Number
G	1.37	1.25	2-020	2-016	1.56	0.87	77-2-120	5100-87	77-1-148	MSSG-DSR/DSP
K	1.87	1.50	2-027	2-023	1.56	1.12	77-2-220	5100-112	77-1-248	MSSK-DSR/DSP
L	2.12	1.50	5-320	2-027	1.56	1.37	77-2-320	5100-137	77-1-348	MSSL-DSR/DSP
M	2.50	2.00	2-132	2-128	2.37	1.62	77-2-420	5100-162	77-1-448	MSSM-DSR/DSP
O	3.00	2.00	2-140	2-225	2.37	2.12	77-2-520	5100-212	77-1-548	MSSO-DSR/DSP
P	3.25	2.00	2-144	2-227	2.37	2.37	77-2-620	5100-237	77-1-648	MSSP-DSR/DSP
Q	3.87	2.12	2-151	2-230	2.37	2.75	77-2-720	5100-275	77-1-748	MSSQ-DSR/DSP
S	4.62	2.12	2-153	2-236	2.37	3.50	77-2-920	5100-350	77-1-948	MSSS-DSR/DSP



Contact Configurations

BCR/FCR/CCR Face View Only* - Not to Scale

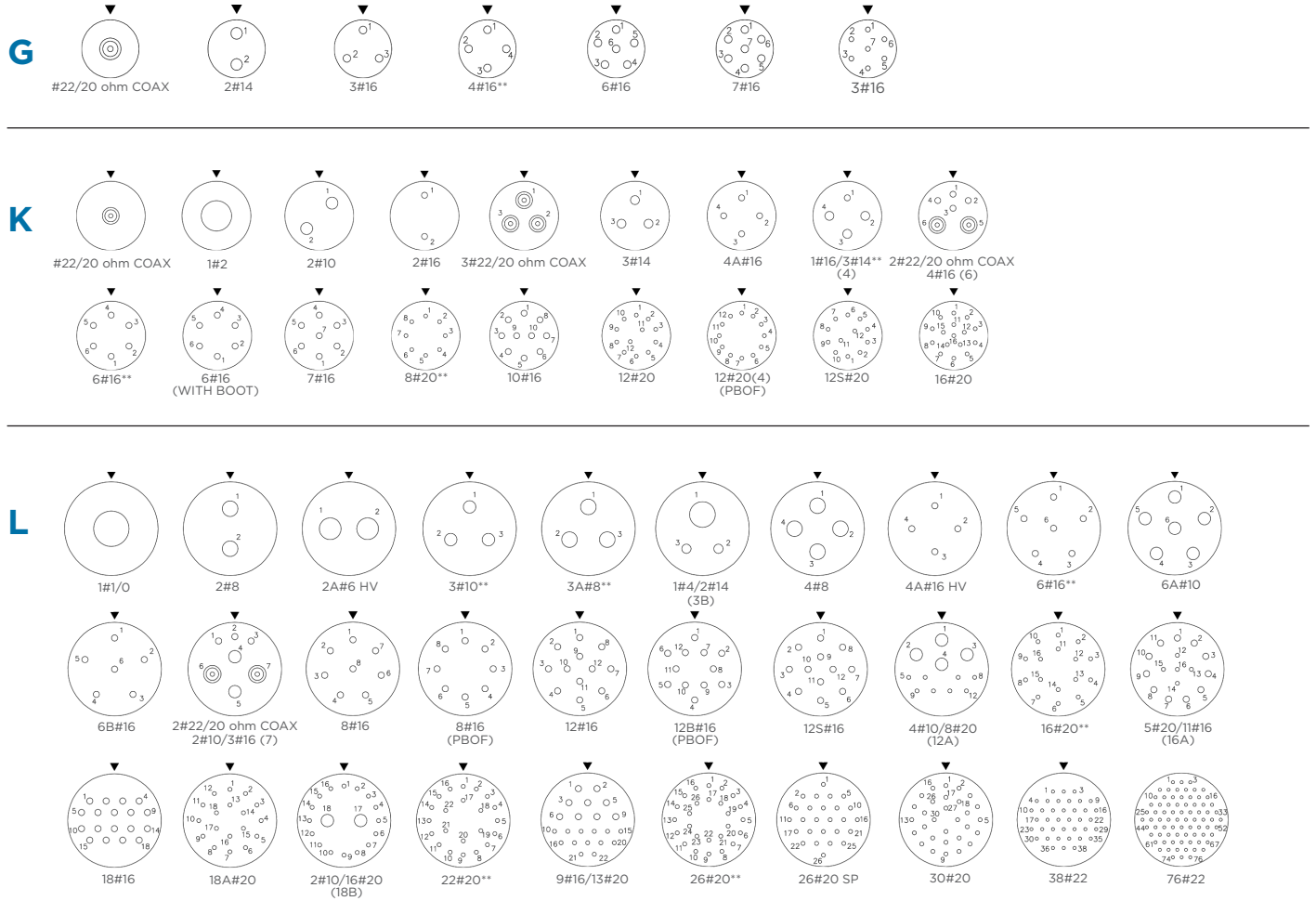

Notes:

- * CCR face view available upon request.
- ** Upon request, these configurations are also available with the PBOF option.
- ▼ This symbol refers to the receptacle shell keyway which keys the BCR, FCR, CCR shell to the mating CCP shell.
- PBOF is the abbreviation for pressure balanced oil filled style connectors, reference catalog for more information.



Contact Configurations

BCR/FCR/CCR Face View Only* - Not to Scale

M

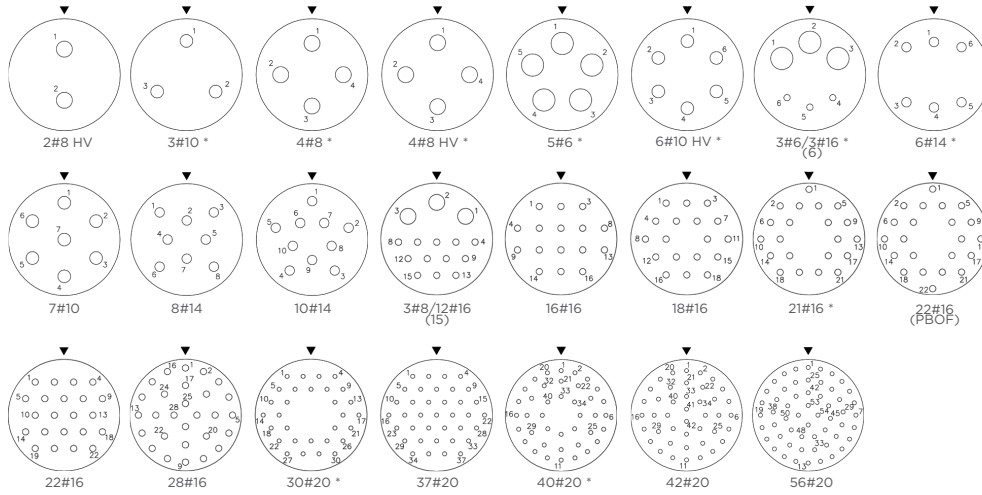

O

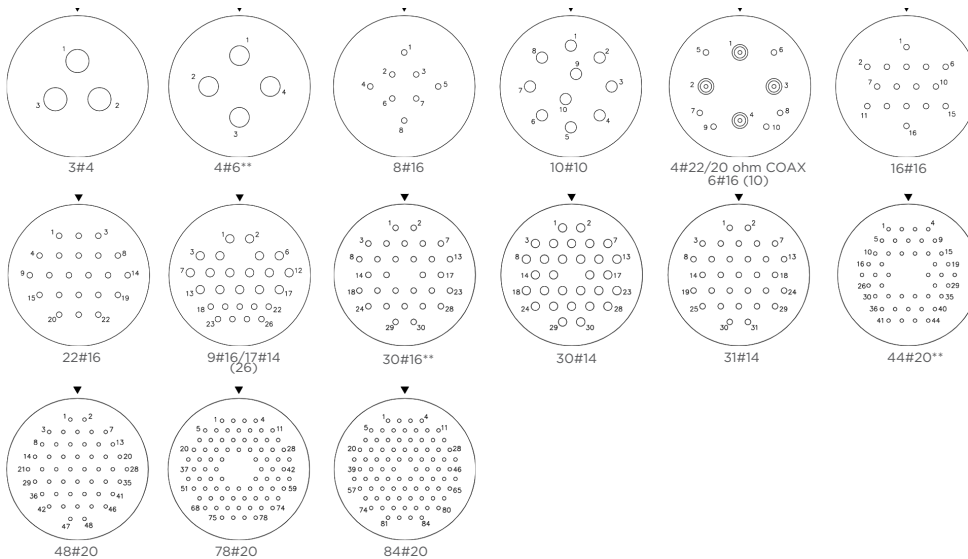

Notes:

- * CCR face view available upon request.
- ** Upon request, these configurations are also available with the PBOF option.
- ▼ This symbol refers to the receptacle shell keyway which keys the BCR, FCR, CCR shell to the mating CCP shell.
- PBOF is the abbreviation for pressure balanced oil filled style connectors, reference catalog for more information.



Contact Configurations

BCR/FCR/CCR Face View Only* - Not to Scale

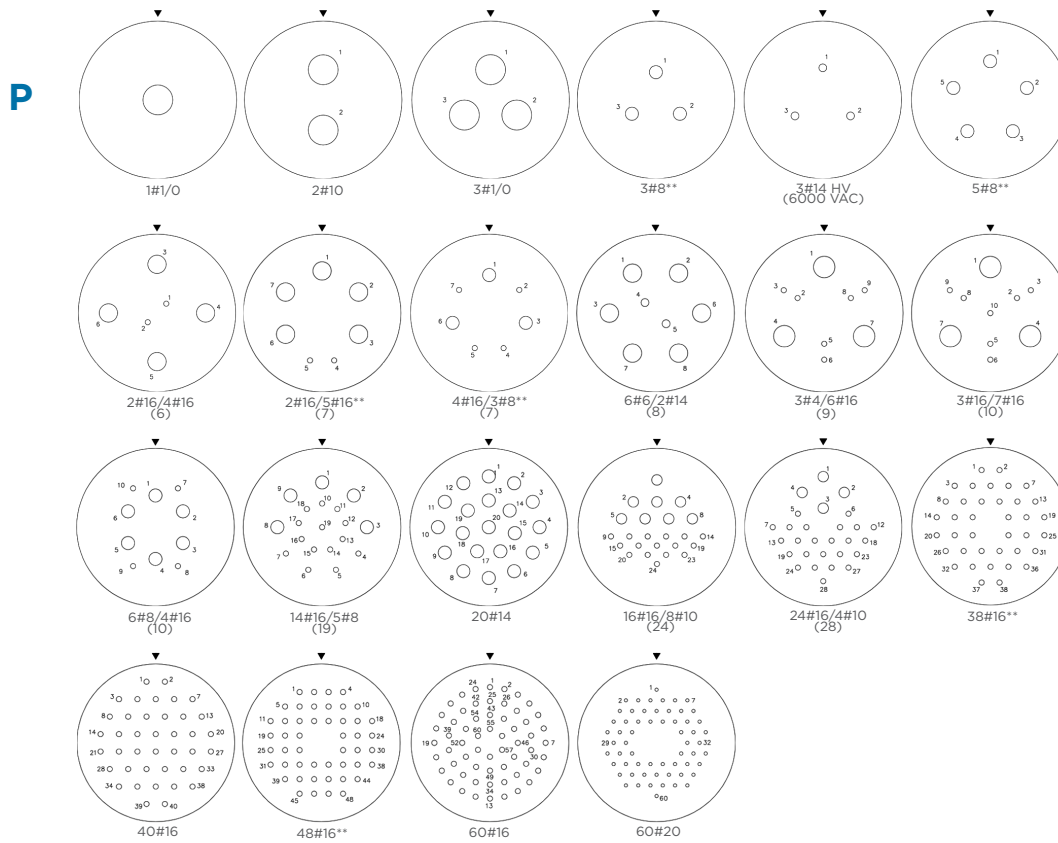

Notes:

- * CCR face view available upon request.
- ** Upon request, these configurations are also available with the PBOF option.
- ▼ This symbol refers to the receptacle shell keyway which keys the BCR, FCR, CCR shell to the mating CCP shell.
- PBOF is the abbreviation for pressure balanced oil filled style connectors, reference catalog for more information.



Contact Configurations

BCR/FCR/CCR Face View Only* - Not to Scale

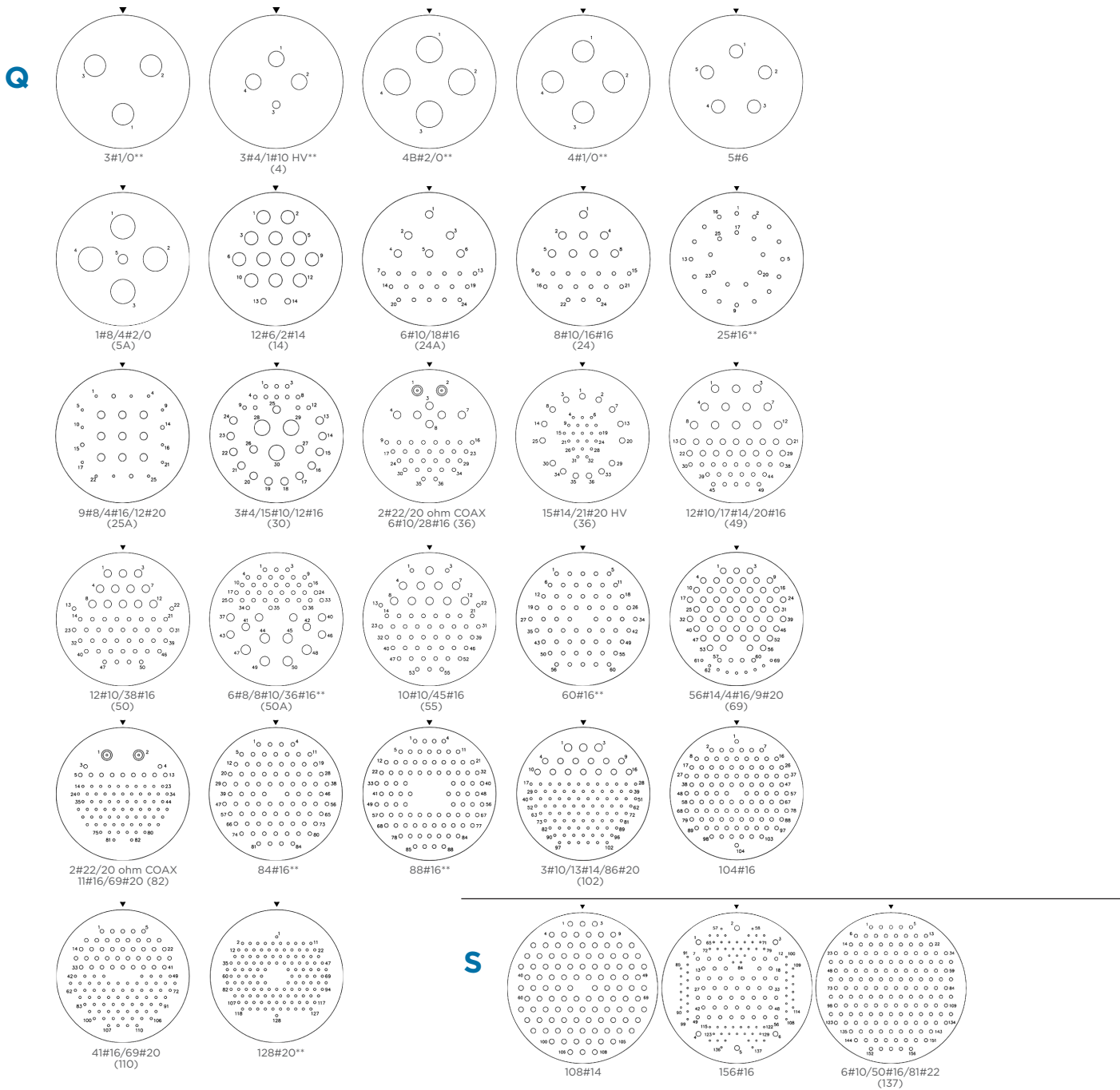

Notes:

- * CCR face view available upon request.
- ** Upon request, these configurations are also available with the PBOF option.
- ▼ This symbol refers to the receptacle shell keyway which keys the BCR, FCR, CCR shell to the mating CCP shell.
- PBOF is the abbreviation for pressure balanced oil filled style connectors, reference catalog for more information.



Contact Configurations - Fiber Optic

BCR/FCR/CCR Face View Only* - Not to Scale

L

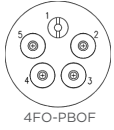

M

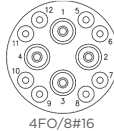
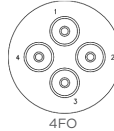

O

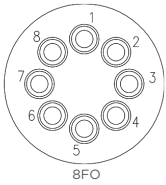
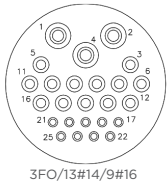
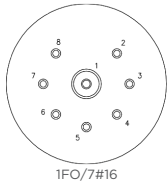

P

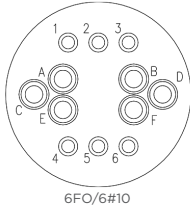
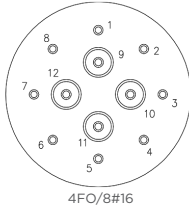
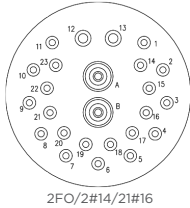

Q

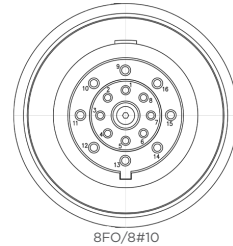
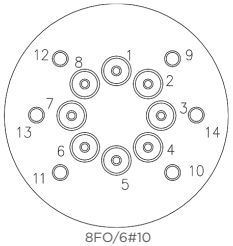
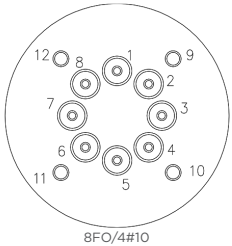
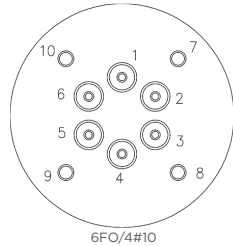

S

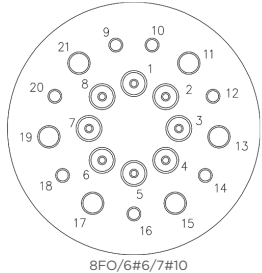
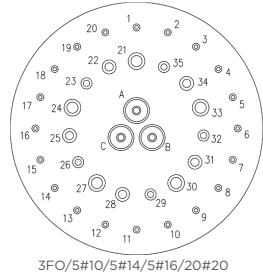

Notes:

- * For CCP face view contact configurations available please contact TE.
- For further information please see TE's SEACON Dry-Mate Fiber Optic brochure or contact TE.



Contact Configurations - 'Specials'

BCR/FCR/CCR Face View Only* - Not to Scale

L

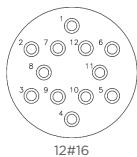

12#16

Q

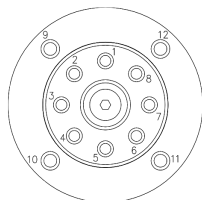

8FO/4#10

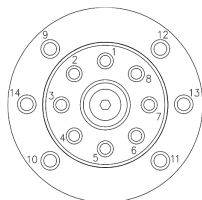

8FO/6#10

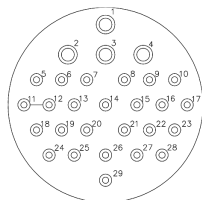

25#16/4#10

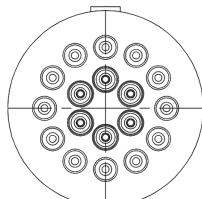

6FO/12#12

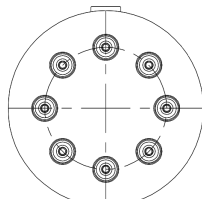

8FO

S

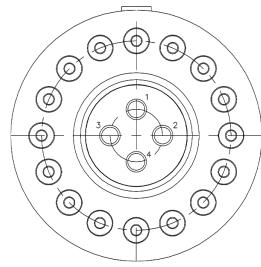

16FO/4#8

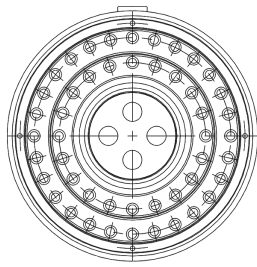

48FO/4#8

Notes:

- * For CCP face view contact configurations available please contact TE.
- For further information please see TE's SEACON Dry-Mate Fiber Optic brochure or contact TE.

LET'S CONNECT

We make it easy to connect with our experts and are ready to provide all the support you need. Just call your local support number or visit www.te.com/industrial to chat with a Product Information Specialist.

TECHNICAL SUPPORT

te.com/support-center

US Inside Sales:

Phone: +1 619-562-7071

Email: elcajonsales@te.com

Phone: +1 979-865-8846

Email: bellvillesales@te.com

Phone: +1 401-637-4952

Email: eastcoastsales@te.com

North America +1 800 522 6752

North America (Toll) +1 717 986 7777

EMEA/South Africa +800 0440 5100

EMEA (Toll) +31 73 624 6999

India (Toll-Free) +800 440 5100

UK Inside Sales:

Phone: +44 (0) 1493-652733

Email: gtyarmouthsales@te.com

France Inside Sales:

Phone: +33 2 43 61 45 45

Email: offshore-ckb@te.com

Brazil Inside Sales:

Phone: +55 21 3592-0920

Email: simone.carvalho@te.com

te.com/MOG

AMP, AGASTAT, CII, DEUTSCH, HARTMAN, KILOVAC, MICRODOT, NANONICS, POLAMCO, Raychem, SEACON, TE, TE Connectivity and the TE connectivity (logo) are trademarks owned or licensed by TE Connectivity. Other products, logos, and company names mentioned herein may be trademarks of their respective owners.

While TE Connectivity (TE) has made every reasonable effort to ensure the accuracy of the information herein, nothing herein constitutes any guarantee that such information is error-free, or any other representation, warranty or guarantee that the information is accurate, correct, reliable or current. The TE entity issuing this publication reserves the right to make any adjustments to the information contained herein at any time without notice. All implied warranties regarding the information contained herein, including, but not limited to, any implied warranties of merchantability or fitness for a particular purpose are expressly disclaimed. The dimensions herein are for reference purposes only and are subject to change without notice. Specifications are subject to change without notice.

Consult TE for the latest dimensions and design specifications.

© 2020 TE Connectivity All Rights Reserved.

2359240-1 02/20