

THIS DRAWING IS UNPUBLISHED. RELEASED FOR PUBLICATION
 © COPYRIGHT - By - ALL RIGHTS RESERVED.

REVISIONS				
P	LTR	DESCRIPTION	DATE	APVD
F		REVISED PER ECO-17-000623	28JUL2017	SY SY

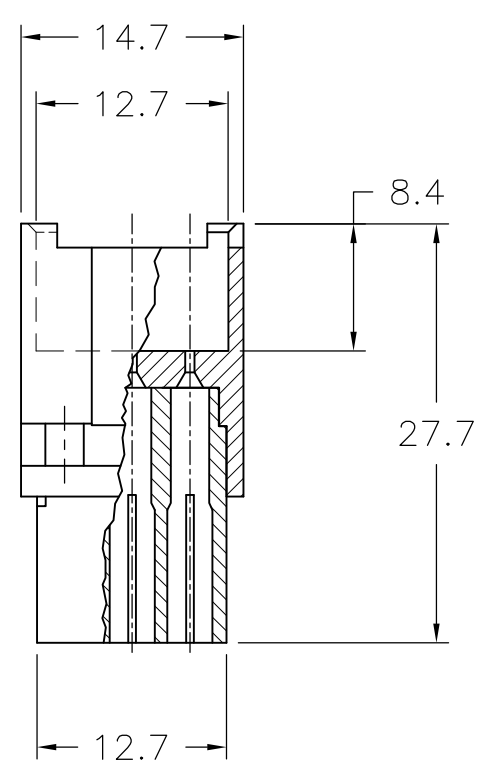

- 1 MATERIAL: 20% GLASS FILLED NORYL, COLOR: GREY RAL 7032.
- 2 BLOCK MARKING AND CAVITY NUMBERS PRINTED IN GREEN COLOR.

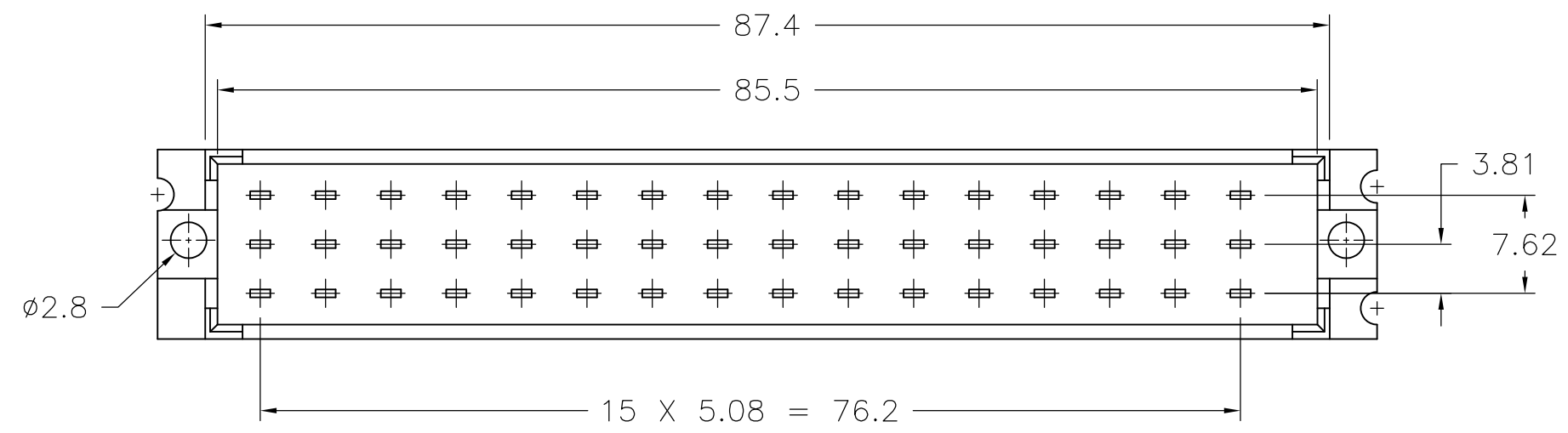
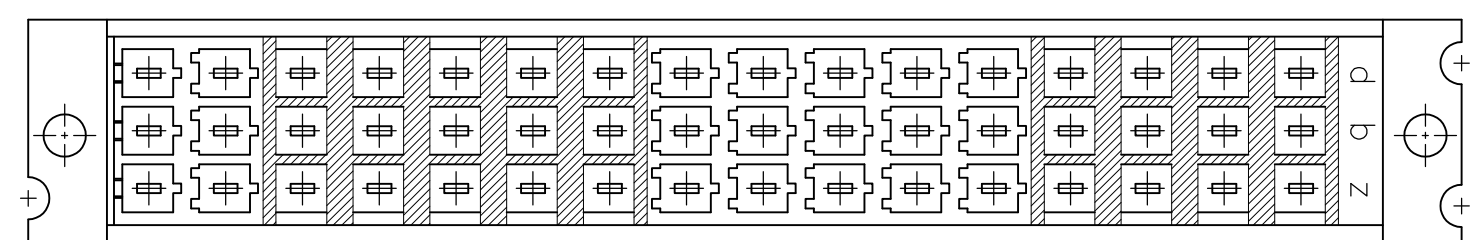
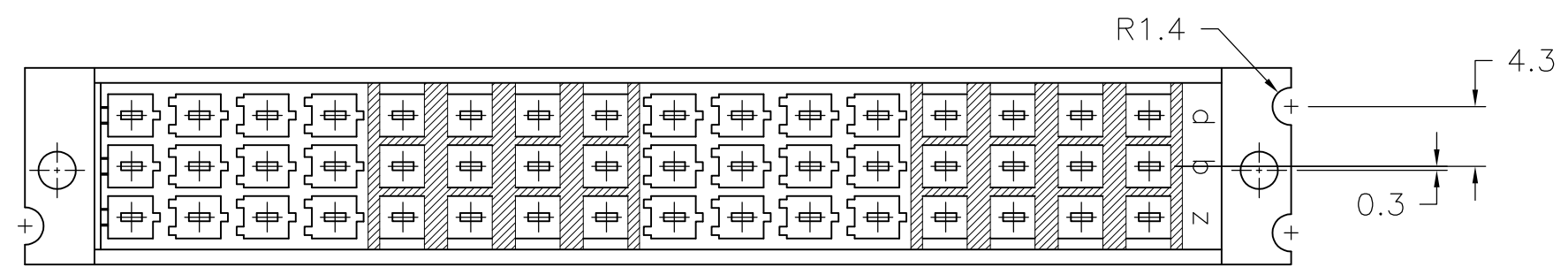
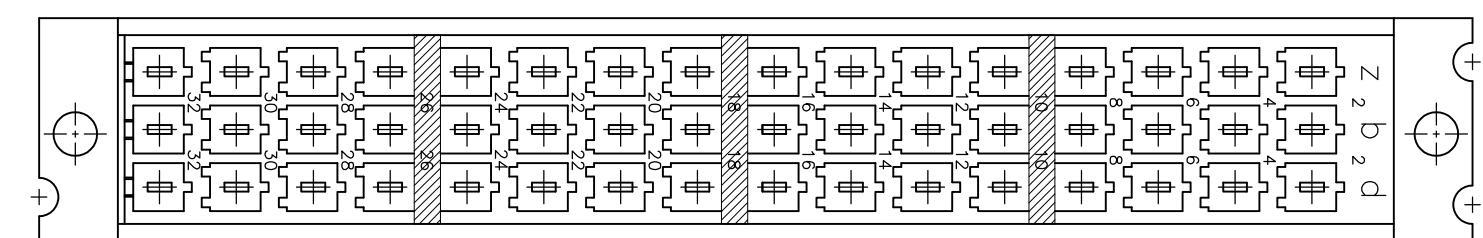
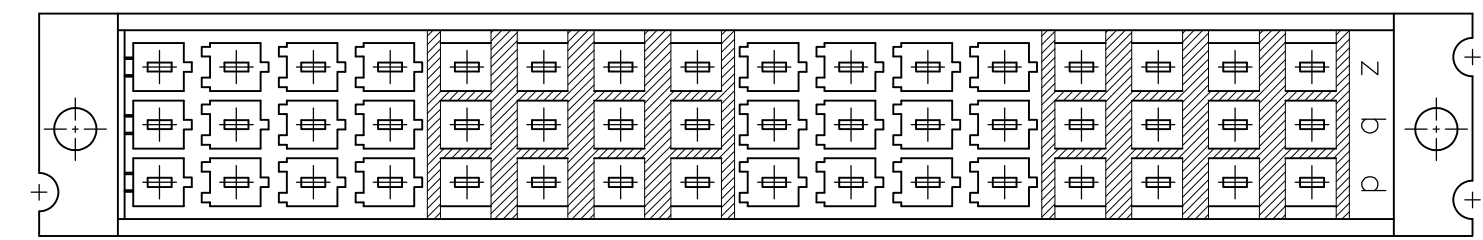
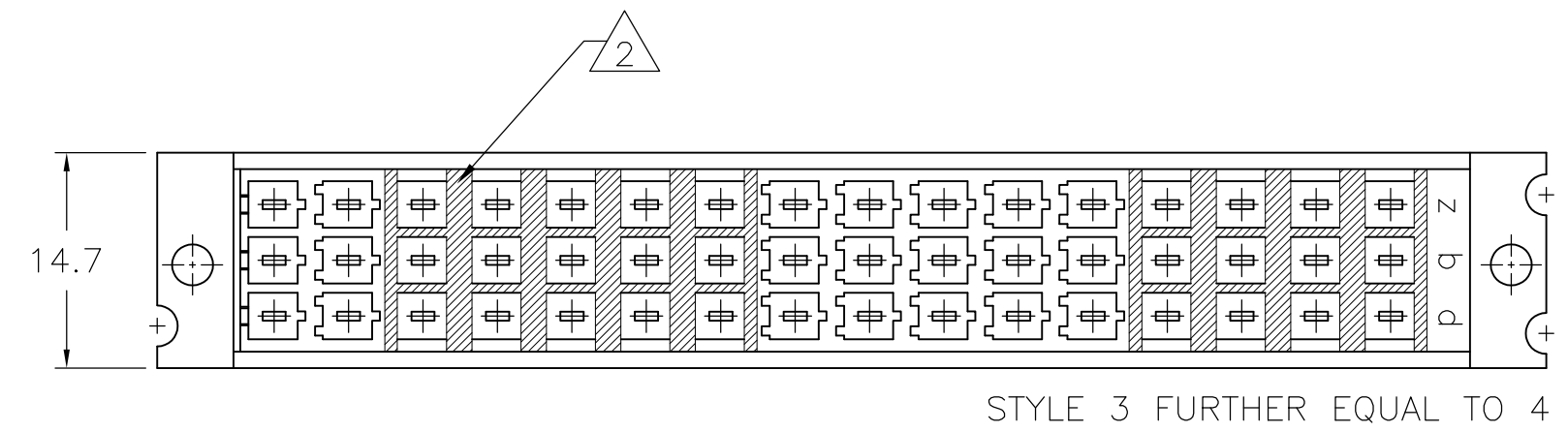
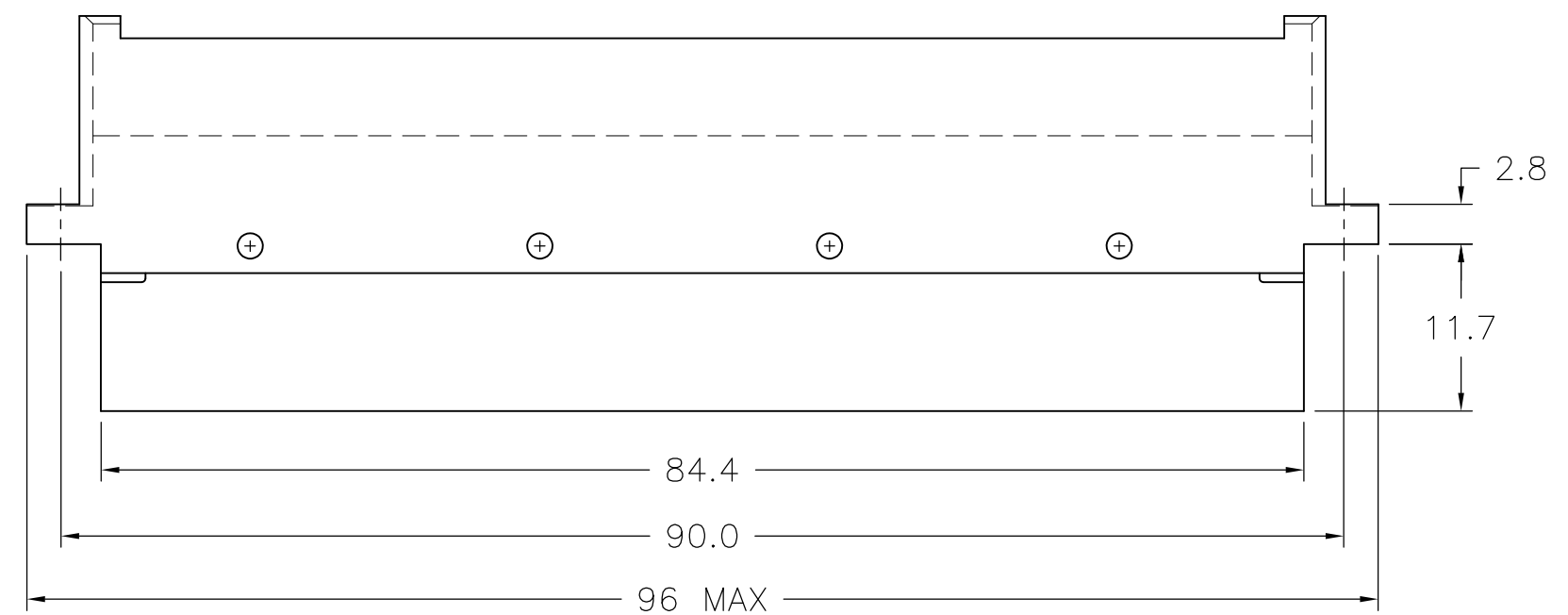

	5	1-166570-0
OBSOLETE	4	166570-9
OBSOLETE	3	166570-8
OBSOLETE	1	166570-7
OBSOLETE	2	166570-1
	STYLE	PART NUMBER

THIS DRAWING IS A CONTROLLED DOCUMENT.		DWN B.CARBO 16JAN2013	TE Connectivity	
DIMENSIONS: mm		CHK R.PATTERSON 16JAN2013		
TOLERANCES UNLESS OTHERWISE SPECIFIED:		APVD R.PATTERSON 16JAN2013	NAME	
0 PLC ± - 1 PLC ± - 2 PLC ± .02 3 PLC ± .005 4 PLC ± .0005 ANGLES ± - FINISH -		PRODUCT SPEC	48 POS, MALE CONN ASSY, FOR COSI CONTACTS, ACC. DIN 41612	
MATERIAL 1		APPLICATION SPEC	SIZE	RESTRICTED TO
		WEIGHT 0.000000	A2 00779	
		CUSTOMER DRAWING	SCALE 2:1	SHEET 1 OF 1
			DRAWING NO C=166570	REV F