

4

3

2

1

THIS DRAWING IS UNPUBLISHED. RELEASED FOR PUBLICATION 20
 © COPYRIGHT 20 BY TYCO ELECTRONICS CORPORATION. ALL RIGHTS RESERVED.

LOC	DIST	REVISIONS				
DS	-	P	LTR	DESCRIPTION	DATE	DWN
				SEE SHEET 2		

INSPECTION ITEM NO.
 SHEET 1 : (1) ~ (3)
 ◀:6sigma CONTROLLED DIMENSION
 ■:QIP INSPECTION ITEM

GENERAL TOLERANCE : ±0.2

D

D

C

C

B

B

A

A

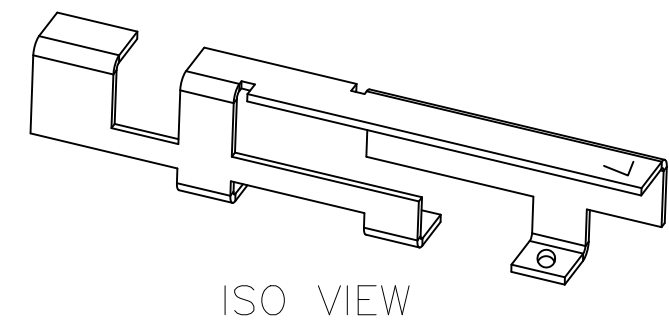
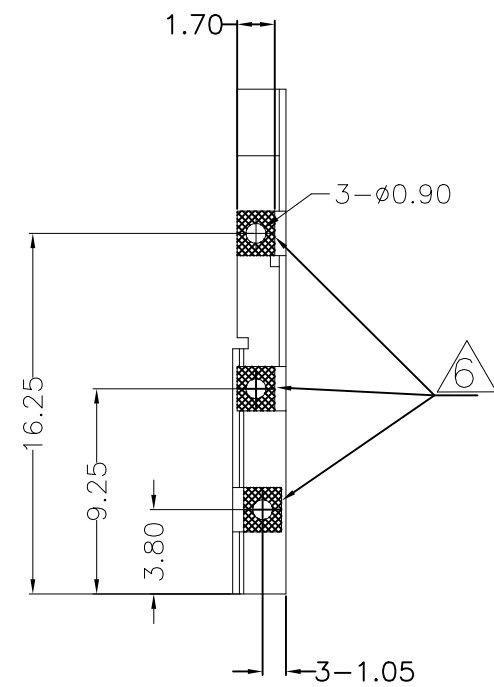
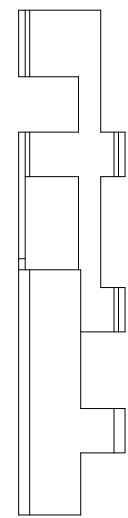
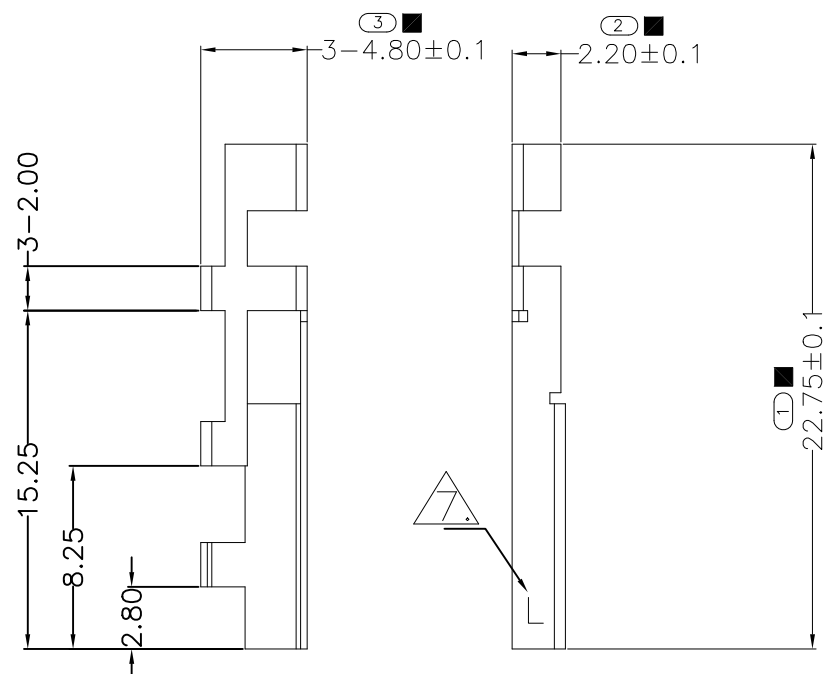

NOTE

- Material : SUS 304 1/2H
 - Thickness : 0.3 t
 - Ni-Plating 1.0~5.0 micro meter
Overplated with Sn-plating 1.0~5.0 micro meter
 - Cutting Burr : 0.1mm MAX
 - Coplanarity : 0.1mm MAX
- △6 SMD Area
 △7 Stamping Specification : Intaglio "L"

<small>THIS DRAWING IS A CONTROLLED DOCUMENT FOR TYCO ELECTRONICS CORPORATION IT IS SUBJECT TO CHANGE AND THE CONTROLLING ENGINEERING ORGANIZATION SHOULD BE CONTACTED FOR THE LATEST REVISION.</small>		DWN JH.LIM 26-SEP-12 CHK JH.LIM 26-SEP-12 APVD JH.LIM 26-SEP-12		TE Connectivity	
DIMENSIONS: mm		TOLERANCES UNLESS OTHERWISE SPECIFIED: GENERAL TOLERANCE IS ±0.1 0-PLC ± 1-PLC ± 2-PLC ± 3-PLC ± 4-PLC ± ANGLES ±		NAME DUAL BAND WiFi ANTENNA, STAMPED METAL, SMD TYPE	
MATERIAL -		FINISH -		SIZE A3 CAGE CODE 300779 DRAWING NO. C-2108517-2 RESTRICTED TO -	
CUSTOMER DRAWING				SCALE 3:1 SHEET 1 OF 2 REV A5	

4

3

2

1

THIS DRAWING IS UNPUBLISHED. RELEASED FOR PUBLICATION 20
COPYRIGHT 20 BY TYCO ELECTRONICS CORPORATION. ALL RIGHTS RESERVED.

LOC	DIST	REVISIONS				
DS	-	P	LTR	DESCRIPTION	DATE	DWN
		A5		Updated description of Part name	2019.03.07	DW

GENERAL TOLERANCE : ±0.2

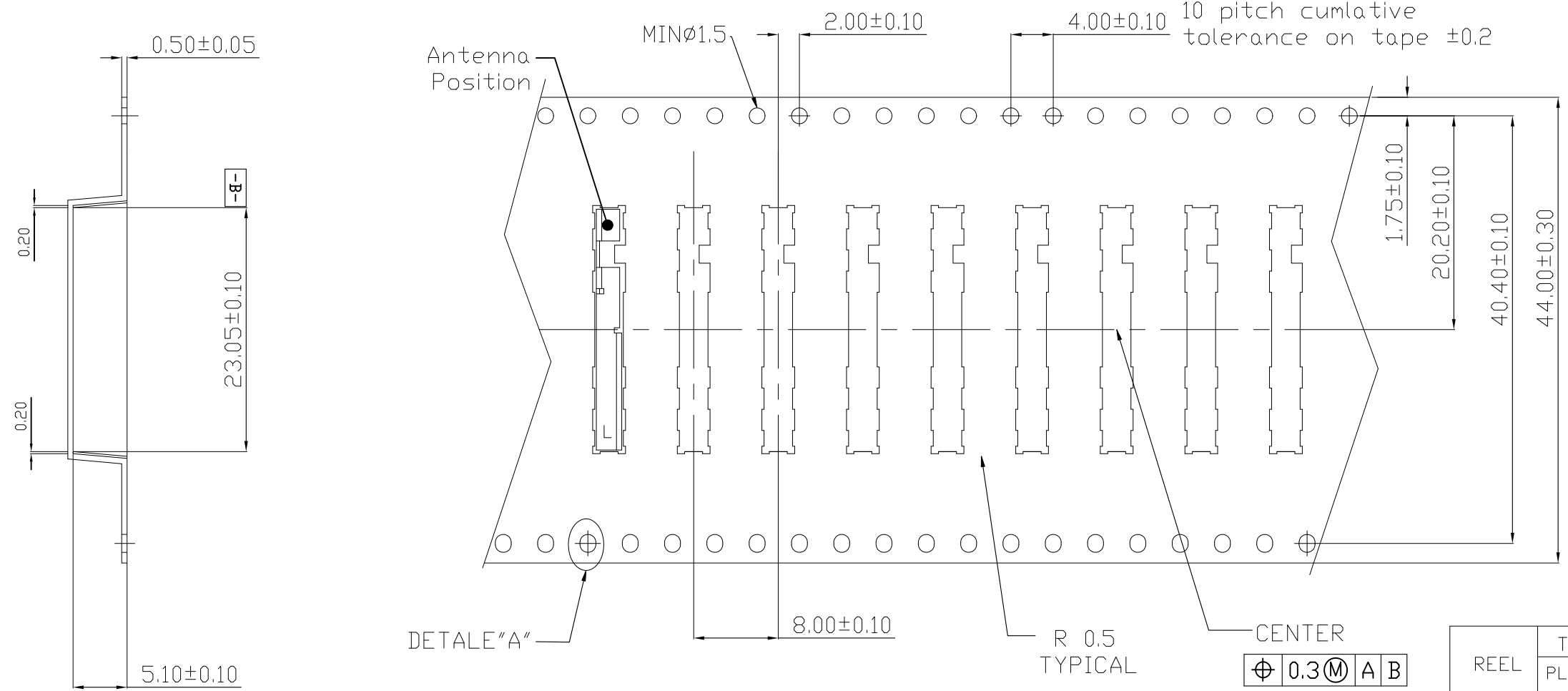

REEL	TYPE	COLOR	HUB	SIZE
	PLASTIC	BLACK	80	330
SHEET	CL		POCKET	POCKET
	44mmX0.5t		COUNTER	1,500

⊕ 0.3 ⊕ A B

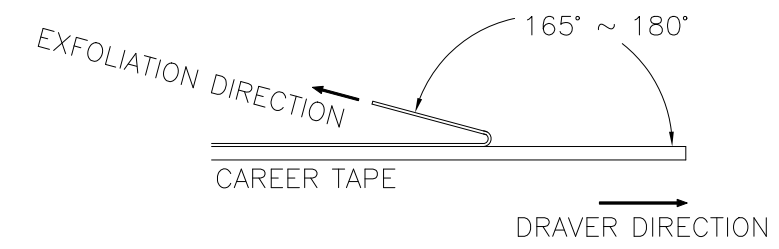
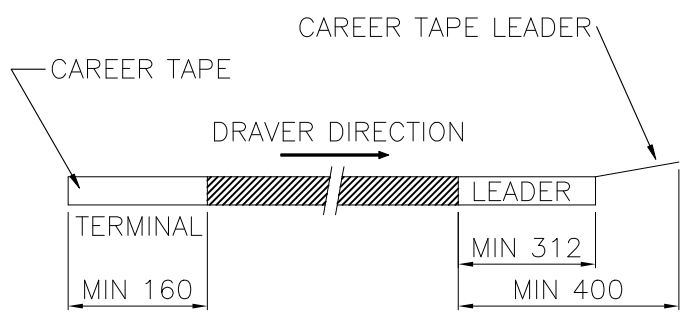
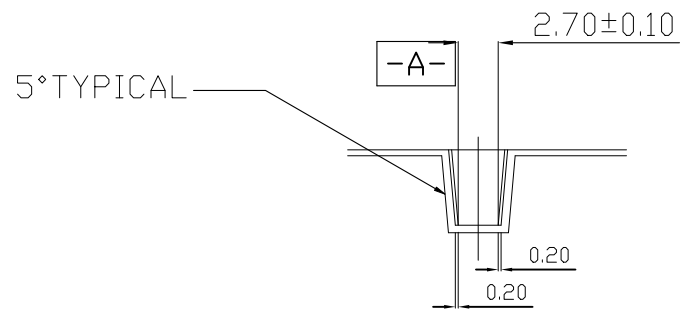
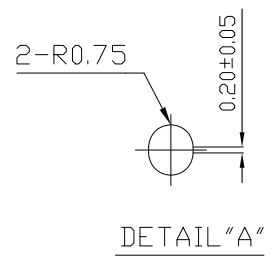

1. APPLICABLE HDR P/N: TBD
2. PACKING Q'TY : 1500EA/ REEL
3. EXFOLIATION STRENGTH OF COVER TAPE : 0.1 ~ 1.27N (10~130gf)
4. MATERIAL : CAREER TAPE : PS 0.4T
COVER TAPE : PET 0.08T
PLASTIC REEL : PS (CONDUCTIVE)

THIS DRAWING IS A CONTROLLED DOCUMENT FOR TYCO ELECTRONICS CORPORATION IT IS SUBJECT TO CHANGE AND THE CONTROLLING ENGINEERING ORGANIZATION SHOULD BE CONTACTED FOR THE LATEST REVISION.

DIMENSIONS: mm	TOLERANCES UNLESS OTHERWISE SPECIFIED: GENERAL TOLERANCE IS ±0.1	DWN JH.LIM 26-SEP-12	TE Connectivity NAME DUAL BAND WiFi ANTENNA, STAMPED METAL, SMD TYPE
	0-PLC ± 1-PLC ± 2-PLC ± 3-PLC ± 4-PLC ± ANGLES ± FINISH -	CHK JH.LIM 26-SEP-12	
		APVD JH.LIM 26-SEP-12	
MATERIAL -	FINISH -	PRODUCT SPEC -	SIZE A3 CAGE CODE 300779 DRAWING NO C-2108517-2 RESTRICTED TO - APPLICATION SPEC - WEIGHT - CUSTOMER DRAWING SCALE 2:1 SHEET 2 OF 2 REV A5