

1. INTRODUCTION

This specification covers the requirements for application of Compact Seal Splice connector used for an electrical power connection. This connector is available in sealed for multiple wire gauges. The connector consists of a housing with a wire entry hole at each end, an internal contact, and two buttons. The wire entry holes, and the housing features a stop that ensures proper wire insertion depth. When pressed, the buttons force the wires into the contact for left or right side independent termination.



NOTE

It is strongly recommended to locate the sealed connector inside an enclosure if it is used outside or underground.

Basic terms and features of this product are provided in Figure 1.

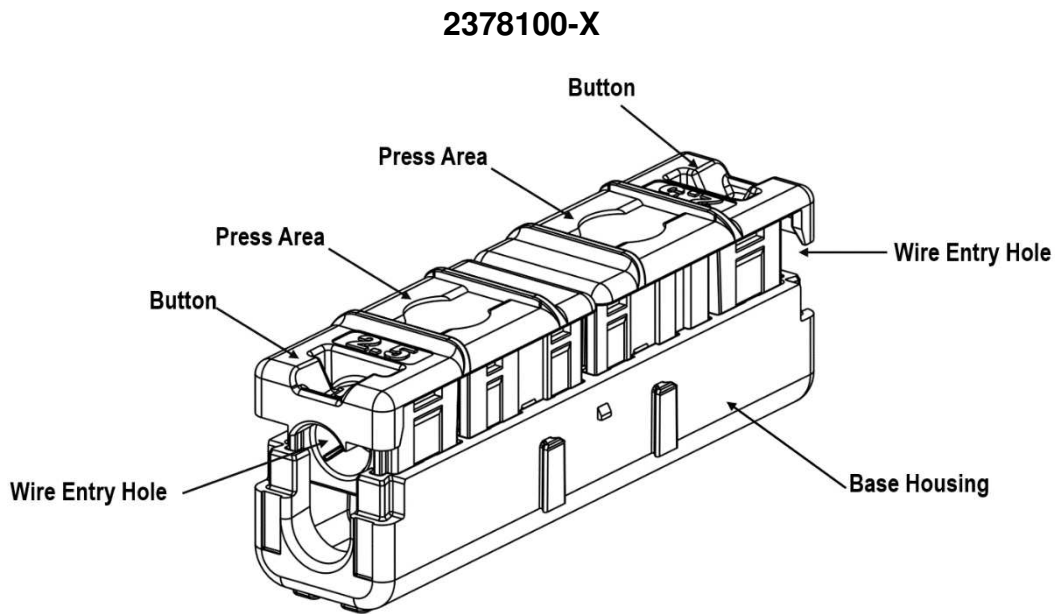

Figure 1



Part Number	Wire Size	Button Color	Housing Color	Grade
2378100-1	12-14AWG, 2.5mm ²	Red 	Clear	UL94 V-0, UL746C F1, GWT 750°C, IP X7.
2378100-2	14-16AWG, 1.5mm ²	Orange 		
2378100-3	16-18AWG, 1.5/0.75mm ²	Blue 		

Table 1

2. WIRE SELECTION AND PREPARATION

The connector accepts copper stranded wire having the sizes and types given in Table 2. Non-concentric wire is not acceptable.

The wire must be clean and free of contaminants, such as dust or other substances that can compromise the insulation diameter. The wire insulation must not be damaged or cut. The wire must have no spacing deformation or burrs. The wire must not be stripped.

Reference Figure 2 for quality requirements of the wire end.

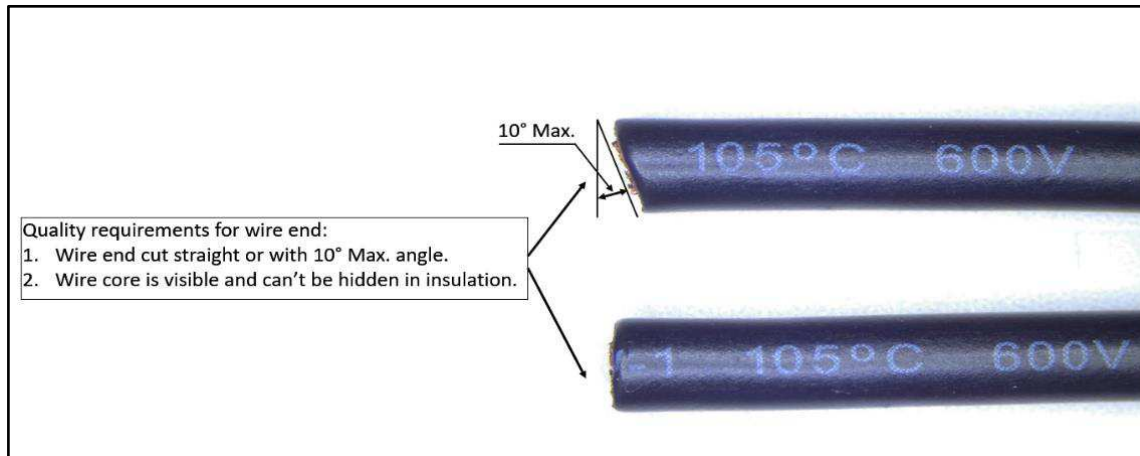

Figure 2

Part number	Certified Wire Standards	Current	Max. insulation diameter
2378100-X	IEC 60245 57(YZW) ¹ or equivalent	2.5mm ² : 20A Max.	4.1mm
		1.5mm ² : 15A Max.	3.4mm
		1.0mm ² : 10A Max.	2.7mm
		0.75mm ² : 6A Max.	2.5mm
	UL1015 or equivalent	12 AWG: 20 A Max.	4.1mm
		14 AWG: 15 A Max.	3.6mm
		16 AWG: 10 A Max.	3.1mm
		18 AWG: 7 A Max.	2.9mm

¹ Remove the Jacket before use, see Figure 3.

Table 2

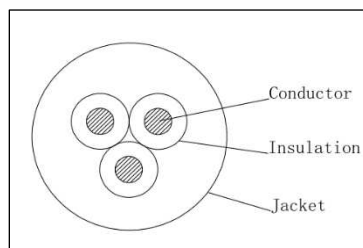

Figure 3

3. ASSEMBLY PROCEDURE

STEP 1: PREPARE SUPERSEAL AND WIRE.

Cut off the front part of the wire to ensure that the Wire core and the insulation cut are flush. Ref to Figure 2



STEP 2: INSERT THE WIRE.

Observe through the transparent button that the wire end touch the button stop surface.

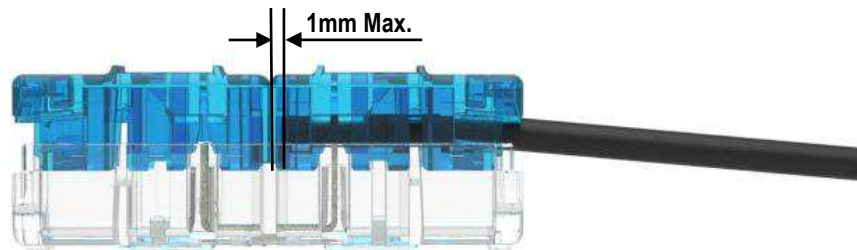

STEP 3: PUSH DOWN THE BUTTON WITH A SPECIAL TOOLS.

The special tools are placed on the pressing area of the button and pressed in place at one time. Until the tool is unlocked

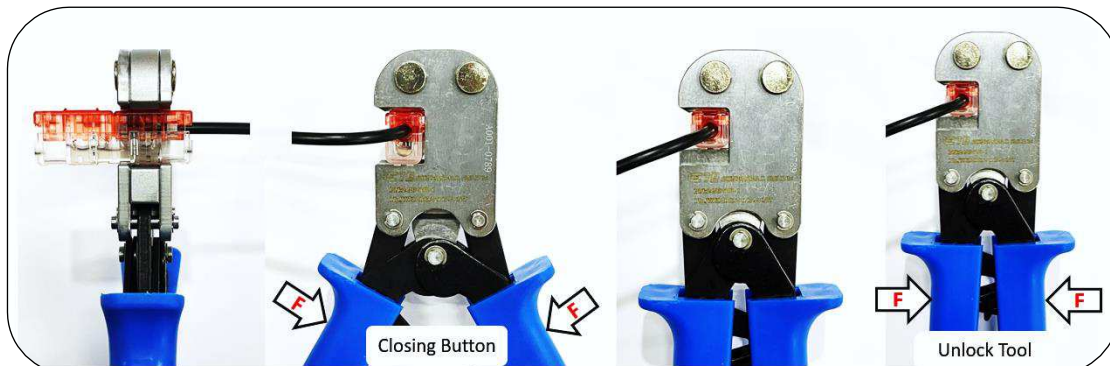
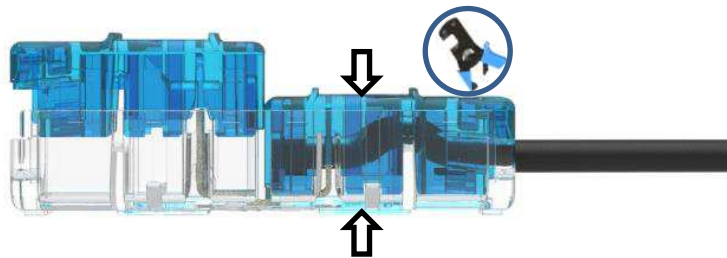

NOTE

The picture shows how to use the special hand tool, and the appearance of the special hand tool may be slightly different with actual tool 2403668.

STEP 4: PEPEAT 1&2&3 ON THE OTHER SIDE AND COMPLETE THE INSTALLATION.



STACKING STEP: SLIDE SIDE BY SIDE FOR STACKING

