



All numerical values are in metric units [with U.S. customary units in brackets]. Dimensions are in millimeters [and inches]. Unless otherwise specified, dimensions have a tolerance of ± 0.13 [$\pm .005$] and angles have a tolerance of $\pm 2^\circ$. Figures and illustrations are for identification only and are not drawn to scale.

1. INTRODUCTION

This specification covers the requirements for application of MTA 156 connectors. These requirements are applicable to hand or automatic machine tooling. These connectors are available in standard, quad, and card edge. The standard connector is available in 2 through 24 circuit positions, the quad connector is available in 2 through 12, and the card edge connector is available in 3, 6, 9, 12, 15, 18, and 20 through 24. These connectors provide an interconnection between wires and printed circuit (pc) boards.

Each connector consists of a housing and insulation displacement contacts. The housing features a circuit identification marking.

When corresponding with personnel, use the terminology provided in this specification to facilitate your inquiries for information. Basic terms and features of this product are provided in Figure 1.

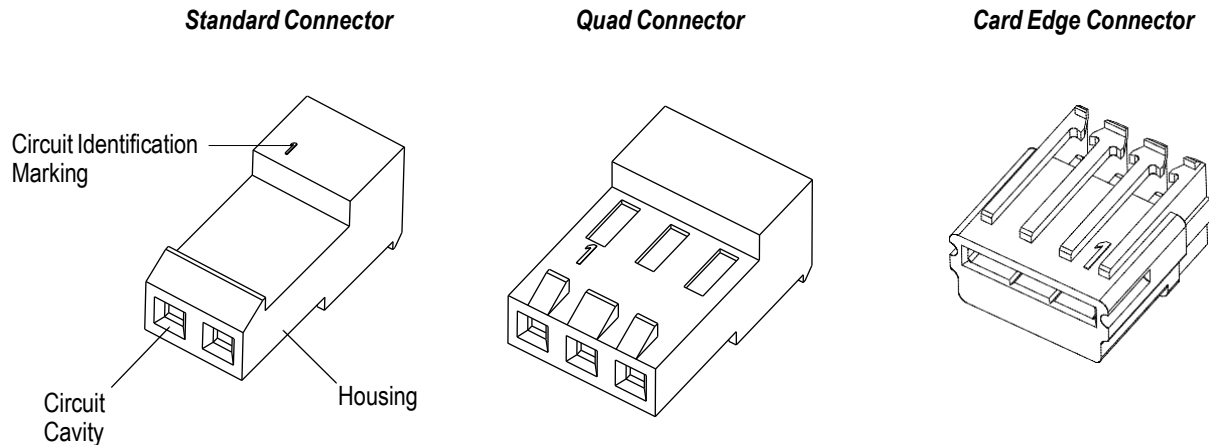

Figure 1

2. REFERENCE MATERIAL

2.1. Revision Summary

Revisions to this application specification include:

- Changed company name and logo
- Updated application specification to corporate requirements
- Added text to Section 1
- Replaced trademark with PTFE in Figure 2
- Added instruction material to and removed 408-9667 and 408-9636 from Paragraph 2.5
- Moved card edge from style to type and added closed end to style in Figure 6 (End)
- Updated formatting for document

2.2. Customer Assistance

Reference Product Base Part Numbers 640426 (standard), 644329 (quad), and 640859 (card edge) and Product Codes 1524 (standard), 1521 (quad), and 1533 (card edge) are representative of MTA 156 connectors. Use of these numbers will identify the product line and expedite your inquiries through a service network established to help you obtain product and tooling information. Such information can be obtained through a local Representative or, after purchase, by calling PRODUCT INFORMATION at the number at the bottom of page 1.

2.3. Drawings

Customer Drawings for product part numbers are available from the service network. If there is a conflict between the information contained in the Customer Drawings and this specification or with any other technical documentation supplied, the information contained in the Customer Drawings takes priority.

2.4. Specifications

Product Specification (108-series) provides product performance and test results. Documents available which pertain to this product are:

- 108-1051 MTA 156 Connector Wire-to-Post System
- 108-1058 MTA 156 Card Edge Connector
- 108-1065 MTA 156 Connector Wire-to-Wire System

2.5. Instructional Material

Instruction Sheets (408-series) provide product assembly instructions or tooling setup and operation procedures and Customer Manuals (409-series) provide machine setup and operating procedures. Documents available that pertain to this product are:

- 644064 MTA 156 Connector Assembly Instructions
- 408-4146 Terminating Head 58247-3 for MTA 156 Receptacle Connectors
- 408-4260 MTA Applicator Assemblies 58575-1 and 58576-1
- 408-4405 Mass Insertion Terminating Head 58646-1
- 408-4439 Ribbon Cable Mass Insertion Tooling Head 58646-2
- 408-6701 MTA 156 Tooling Assembly 58040-1
- 408-6789 Pistol Grip Pneumatic Handle Assembly 58075-1
- 408-6790 Pistol Grip Manual Handle Assembly 58074-1
- 408-6794 Terminating Head 58061-1 for MTA 156 Card Edge Connectors Using Discrete Wire
- 408-6795 MTA Terminating Head 58082-1
- 408-6923 Manual Arbor Frame Assembly 58024-1
- 408-6930 Terminating Head 58247-1 for MTA 156 Receptacle Connectors Using Discrete Wire
- 408-7907 Insertion Tools 59803-1 and 59804-1 for MTA Connectors
- 408-7995 MTA 156 Connector Holding Fixtures
- 408-8054 Insulation Displacement Applicator 466727-1 for MTA Connectors
- 408-8069 Insulation Displacement Applicator 567020-1 for MTA Card Edge Connectors
- 408-9380 MTA Terminating Head (Extended Wear Type) 58247-2
- 408-9393 Pneumatic Power Bench Assembly 58338-1
- 408-9466 Feed Track Assembly 933568-1 for MTA 156 Closed-End Receptacle Connectors
- 408-9450 Terminating Head 58392-1 for MTA Quad Connectors Using Discrete Wire
- 408-9607 Feed-Through Head Assembly 58443-1 For Discrete Wire MTA 156 Receptacles
- 408-9637 Feed Track Assembly 853547-1 and Base Assembly 853542-1
- 408-9650 Die Set Assembly 854176-1 and Base Assembly 854200-1
- 409-5746 Electric Power Unit 931800-1
- 409-5843 2700-lb Pneumatic Power Unit 312522-[]

3. REQUIREMENTS

3.1. Wire Selection and Preparation

Specific wire size and insulation diameter ranges relative to these connectors are tin-plated solid, concentric fused stranded, and concentric stranded wire sizes 26 through 18 AWG with standard PVC thermoplastic insulation having a maximum insulation outside diameter of 2.41 [.095] when terminated one position at a time and 1.78 [.070] when mass terminated. Stranded wire configurations are wire size 18 AWG having 7, 16, and 19 strands, wire size 20 AWG having 7, 10, and 19 strands, wire sizes 22 through 24 AWG having 7, 10, and 19 strands, and wire size 26 AWG having 7 strands.

Underwriters Laboratories (UL) Inc. UL style 1061 is the preferred wire for mass termination and UL style 1007 is initially approved for single termination in all wire sizes. Only specific UL style wire approved by TE Connectivity are provided in Figure 2. Other wire should be submitted for formal evaluation by TE prior to use to verify proper product function.

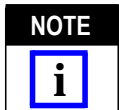

When selecting the approved wire, the guidelines in this specification must be followed. Also, because of variations in wire insulation wall thickness, hardness, and wire stranding, it is recommended to evaluate the selected wire before final application approval.

UL WIRE STYLE	WIRE WALL THICKNESS	TE APPROVED WIRE SIZE (AWG)				
		26	24	22	20	18
UL 1007 PVC Insulation	0.38 [.015]	✓	✓	✓	✓	✓
UL 1061 Semi-Rigid PVC Insulation	0.23 [.009]	✓	✓	✓	✓	✓
UL 1180 Polytetrafluoroethylene (PTFE) Insulation — TFE	0.38 [.015]			✓		
UL 1213 PTFE Insulation — TFE	0.25 [.010]		✓	✓		✓
UL 1316 PVC/Nylon Wall	0.38 [.015]			✓		✓
UL 1429 Irradiated PVC — XLPVC	0.25 [.010]		✓	✓	✓	✓
UL 1430 Irradiated PVC — XLPVC	0.38 [.015]		✓	✓	✓	✓
UL 1569 PVC	0.38 [.015]					✓
UL 3265 Irradiated Polyethylene — XLPE	0.25 [.010]			✓		
UL 3266 Irradiated Polyethylene— XLPE	0.38 [.015]		✓	✓	✓	✓

Figure 2

3.2. Termination

A. Wire

The terminated wire shall meet the requirements specified in Figure 3.

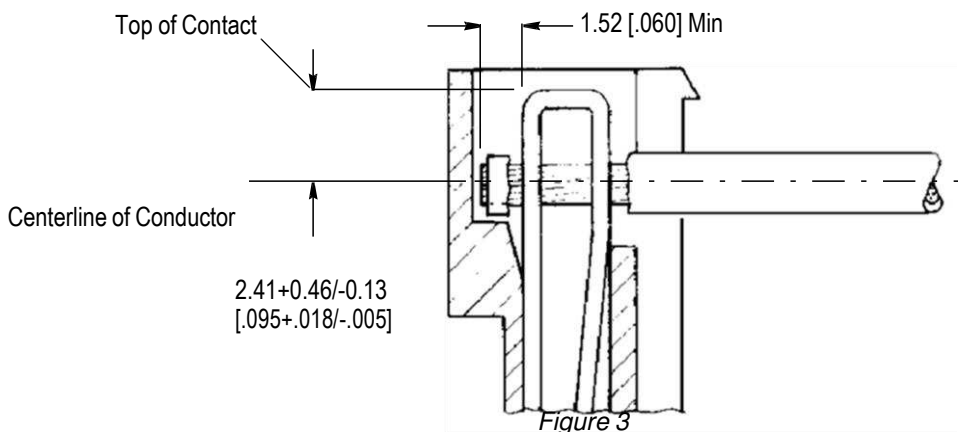

Figure 3

B. Wire Conductors and Insulation

There shall be no broken strands in the conductor after termination. Exposed conductors shall not exceed the limits specified in Figure 4.

Conductor insulation shall be contained within the confines of the insulation strain relief as shown in Figure 5.

C. Contact

There shall be no evidence of physical damage or distortion to any portion of the contact after wire termination.

D. Housing

There shall be no cracks, breaks, or other visible damage to the housing including due to wire termination. Skiving of plastic on the inside wall of the housing cavity is permissible provided that there are no cracks, breaks, or other visible damage to the housing.

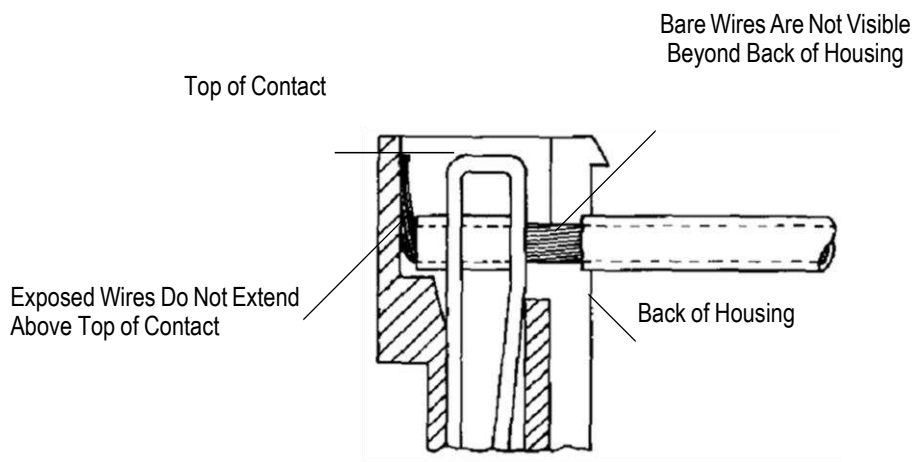

Figure 4

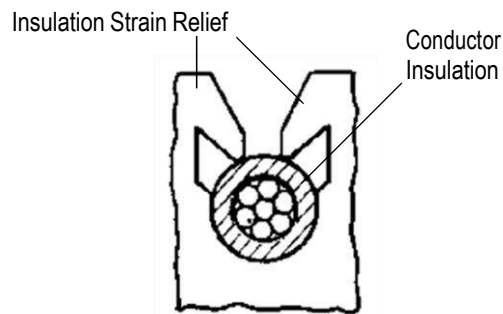

Figure 5

4. QUALIFICATION

MTA 156 connectors are Recognized by Underwriters Laboratories Inc. (UL) in File E28476 and are Certified by CSA International in File LR7 189.

5. TOOLING

Tooling part numbers and instructional material packaged with the tooling available to terminate these connectors are given in Figure 6.

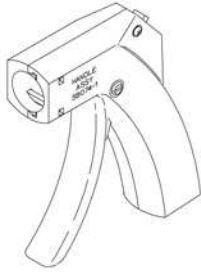

Pistol Grip Manual Handle Assembly 58074-1 (408-6790)



Pistol Grip Pneumatic Handle Assembly 58075-1 (408-6789)

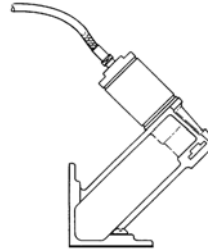

Pneumatic Power Bench Assembly 58338-1 (408-9393)



Electric Power Unit 931800-1 (409-5746)

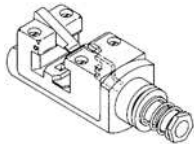

Terminating Head:
58247-1 (408-6930)
58247-2 (408-9380)
58247-3 (408-4146)
58443-1 (408-9607)
58082-1 (408-6795)
58061-1 (408-6794)
58392-1 (408-9450)

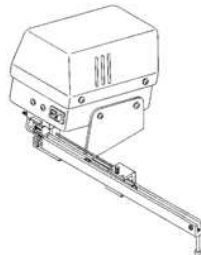

Feed Track Assembly:
933568-1 (408-9466)
853547-1 and Base 853542-1 (408-9637)

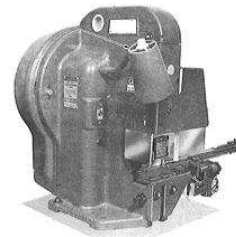

Insulation Displacement Applicator:
466727-1 (408-8054)
567020-1 (408-8069)



Insertion Tool 59804-1 (408-7907)

SINGLE (ONE POSITION AT A TIME) TERMINATION

CONNECTOR		TERMINATING HEAD Used in Handle Assembly 58074-1 Pneumatic Handle Assembly 58075-1 Pneumatic Power Assembly 58338-1 Electric Power Unit 931800-1	FEED TRACK ASSEMBLY Used in Pneumatic Power Assembly 58338-1 Electric Power Unit 931800-1		APPLICATOR	INSERTION TOOL
TYPE	STYLE		Loose-Piece Contacts	Tape Contacts		
Standard	Closed End	58247-1 (Discrete Wire)	933568-1	853547-1 and Base 853542-1	466727-1	59804-1
		58247-2 (Extended Wear)				
		58247-3 (Ribbon Cable)				
	Feed Through	58443-1	—	—	—	59804-1
	Closed End (Posted)	58082-1				
Card Edge	Closed End	58061-1			567020-1	—
Quad	Closed End	58392-1			—	59804-1

Figure 6 (Cont'd)

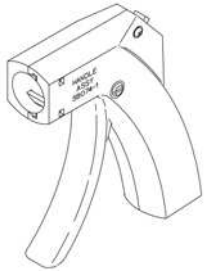

Pistol Grip Manual Handle Assembly 58074-1 (408-6790)



Manual Arbor Frame Assembly 58024-1 (408-6923)

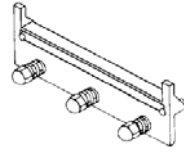

MTA 156 Tooling Assembly 58040-1 (408-6701)



2700-lb Pneumatic Power Unit 312522-1 (409-5843)

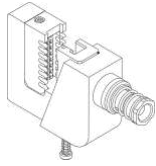

Terminating Head: 58646-1 (408-4405) 58646-2 (408-4439)

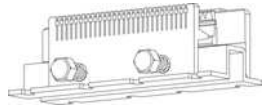

MTA 156 Connector Holding Fixtures (408-7995)

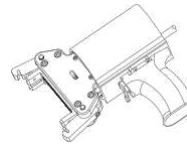

MTA Applicator Assembly 58576-1 (408-4260)

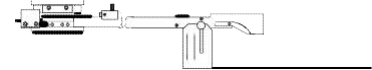

Die Set Assembly 854176-1 and Base Assembly 854200-1 (408-9650)

MASS TERMINATION

CONNECTOR		TERMINATING HEAD Used in Handle Assembly 58074-1	CONNECTOR HOLDING FIXTURE			DIE ASSEMBLY Used in 2700-lb Pneumatic Power Unit 312522-1	
TYPE	STYLE		Part Number	Used in Applicator	Used in Manual Arbor Frame and Tooling Assembly		
Standard	Closed End	—	58244-1	—	58024-1 and 58040-1	854176-1 and Base 854200-1	
			58244-3	58576-1			
	Feed Through	(Discrete Wire) (Notched Cable)	58245-1	—	58024-1 and 58040-1		
			58245-3	58576-1			
Closed End (Posted)	—	58009-1	—	58024-1 and 58040-1			
		58009-2	58576-1				
Feed Through (Posted)	—	58010-2	58576-1		58024-1 and 58040-1		
		58010-2	58576-1				
Card Edge	Closed End	—	59848-1	—		58024-1 and 58040-1	—
			59848-3	58576-1			
Quad	Closed End	—	58244-1	—	58024-1 and 58040-1		
			58244-3	58576-1			
	Feed Through	—	58245-1	—		58024-1 and 58040-1	
			58245-3	58576-1			

Figure 6 (End)

6. VISUAL AID

The illustration below shows a typical application of MTA 156 connectors. This illustration should be used by production personnel to ensure a correctly applied product. Applications which DO NOT appear correct should be inspected using the information in the preceding pages of this specification and in the instructional material shipped with the product or tooling.

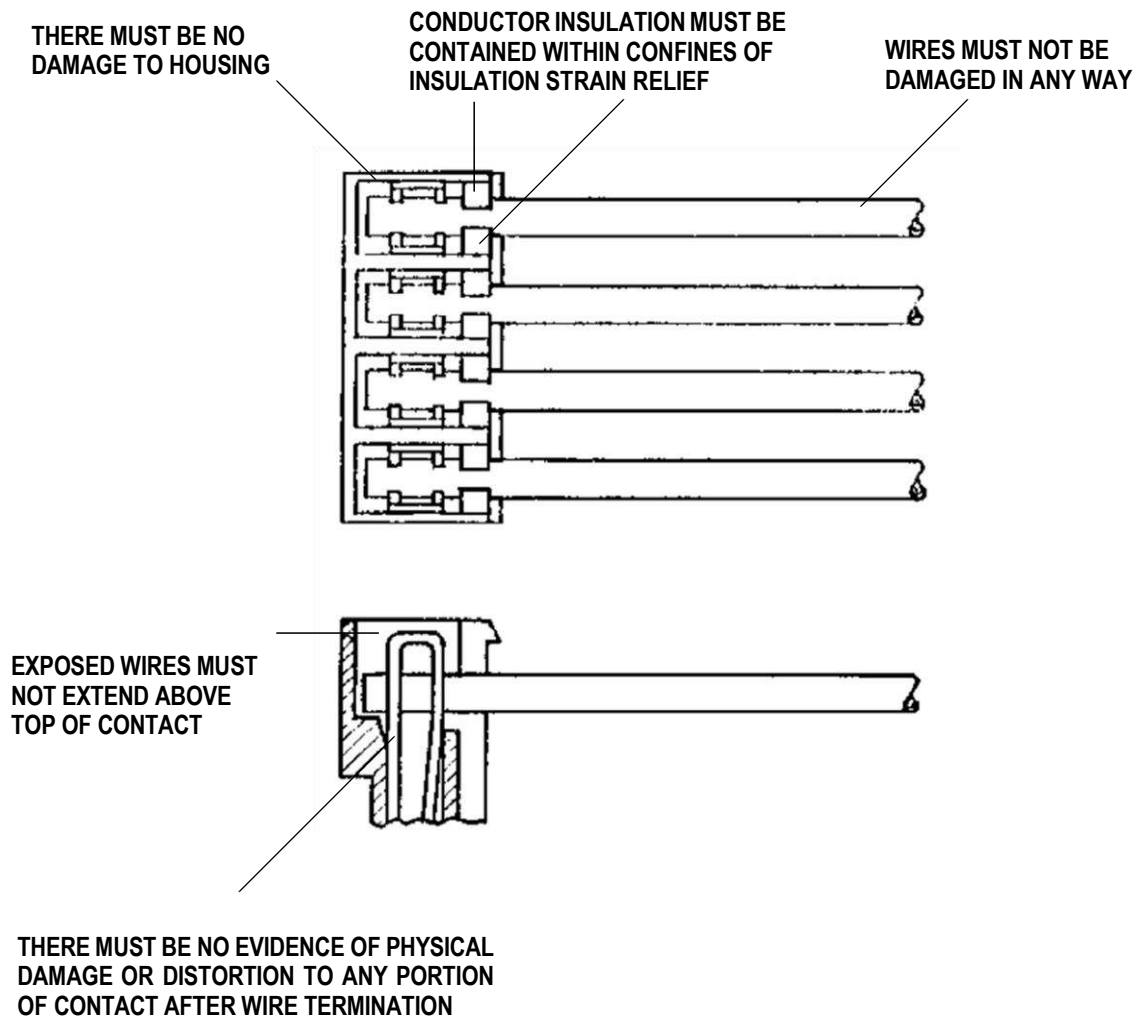

FIGURE 7. VISUAL AID