



**NOTE**

All numerical values are in metric units [with U.S. customary units in brackets]. Dimensions are in millimeters [and inches]. Unless otherwise specified, dimensions have a tolerance of  $\pm 0.13$  [ $\pm .005$ ] and angles have a tolerance of  $\pm 2^\circ$ . Figures and illustrations are for identification only and are not drawn to scale.

## 1. INTRODUCTION

This specification covers the requirements for application of FASTON\* standard straight receptacle terminals with 2D crimp feature for wire-to-wire and wire-to-board applications. This receptacle terminal features a wire barrel which, when crimped, wraps around and crimps the wire. The wire barrel forms the 2D crimp which provides reliable electrical and mechanical performance. The 2D wire barrel also features serrations to help grip and retain the wire within the barrel after crimping.

The terminal accepts a mating tab with a width of 6.3 [.250] or 4.8 [.187] following the UL310 standard. More details can be found in Paragraph 0. This receptacle terminal includes a dimple feature which, when mated, engages the mating tab to provide the required retention force. The terminal is available on reels for terminating with automatic and semi-automatic machines. Requirements for inspecting the crimp height measurement are in Paragraph 3.6.

For correspondence with TE Connectivity personnel, use the terminology provided in this specification to facilitate inquiries for information. Basic terms and features of this product are provided in Figure 1.

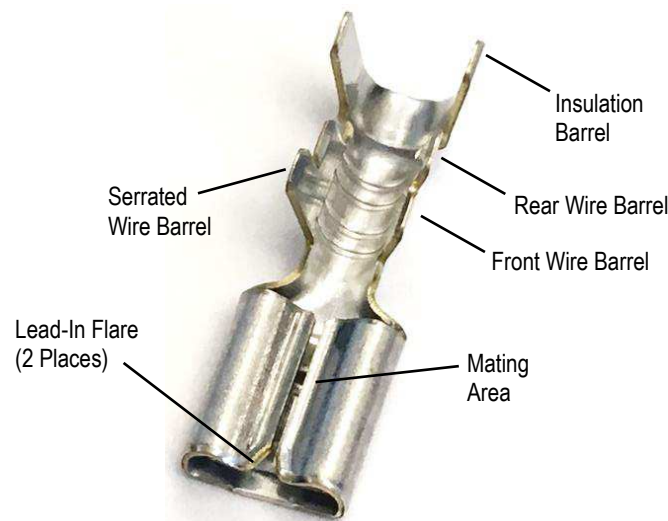

**Figure 1**

## 2. REFERENCE MATERIAL

### 2.1. Revision Summary

Revisions to this application specification include:

- Correct metric to inch conversion of crimp height on ,250 series AWG 14 in figure 4.
- Wire barrel flash allowance for loose piece crimping in hand tools added to section 3.4

## 2.2. Customer Assistance

Reference Product Base Part Number 2238173, 2238174 and Product Code X523 are representative of FASTON\* standard straight receptacle terminals with 2D crimp feature. Use of these numbers will identify the product line and help you to obtain product and tooling information when visiting [www.te.com](http://www.te.com) or calling the number at the bottom of page 1.

## 2.3. Drawings

Customer drawings for product part numbers are available from [www.te.com](http://www.te.com). Information contained in the customer drawing takes priority.

[2238173](#) Customer Drawing – FASTON\* Standard .250 Series Straight Receptacle Terminal with 2D Crimp Feature

[2238174](#) Customer Drawing – FASTON\* Standard .187 Series Straight Receptacle Terminal with 2D Crimp Feature

## 2.4. Specifications

Product Specification [108-143087](#) provides product performance and test results.

## 2.5. Terminal Voltage Rating

Voltage rating is based upon dielectric strength between the terminal and other voltage potential conductors. For these un-insulated terminals, this dielectric strength is determined by 1) the wire insulation used, 2) the housing used (if any), and 3) the application spacings. These appliance business unit terminals with an insulation barrel crimp are designed for UL 1015 wire with insulation rated for 600 volts; so, this is the voltage rating assigned to these terminals. Clearly, if higher dielectric strength wire insulation, larger spacings, and possibly an optional housing are used, larger voltages can be used.

## 2.6. Instructional Material

Instruction sheets (408-series) provide product assembly instructions or tooling setup and operation procedures and customer manuals (409-series) provide machine setup and operating procedures. Instructional material that pertain to this product are:

[408-10390](#) Instruction Sheet – Ocean End-Feed Applicators

## 3. REQUIREMENTS

### 3.1. Safety

Do not stack product shipping containers so high that the containers buckle or deform.

### 3.2. Storage

#### A. Ultraviolet Light

Prolonged exposure to ultraviolet light may deteriorate the chemical composition used in the product material.

#### B. Shelf Life

The product should remain in the shipping containers until ready for use to prevent deformation to components. The product should be used on a first in, first out basis to avoid storage contamination that could adversely affect performance.

#### C. Chemical Exposure

Do not store product near any chemical listed below as they may cause stress corrosion cracking in the material.

Alkalis	Ammonia	Citrates	Phosphates	Citrates	Sulfur Compounds
Amines	Carbonates	Nitrites	Sulfur	Nitrites	Tartrates

**NOTE**

Where the above environmental conditions exist, phosphor-bronze contacts are recommended instead of brass if available.

### 3.3. Wire Selection and Preparation

Part number 2238173 (6.3 [.250] Series) accepts 1 stranded copper wire sizes 12 AWG to 22 AWG with an insulation diameter range of 1.56-4.0 [.061-.157]. Part number 2238174 (4.8 [.187] Series) accepts 1 stranded copper wire sizes 14 AWG to 24 AWG with an insulation diameter range of 1.41-3.46 [.055-.136].

Each wire must be stripped to the dimension given in Figure 2.

**CAUTION**

Care must be taken not to nick, scrape, or cut any part of the wire during the stripping operation.

Note: Not to Scale

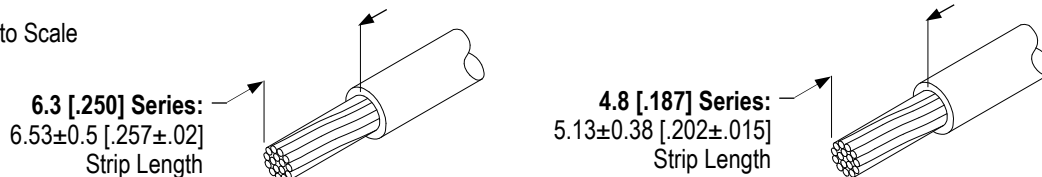

Figure 2

### 3.4. Contact Crimp

#### A. Cutoff Tab

The cutoff tab is the remaining portion of the carrier strip after the contact is cut from the strip. The cutoff tab must not exceed the dimensions of 0.5mm [.020"] at both terminal ends as shown in Figure 3.

#### B. Wire Barrel Crimp

The crimp applied to the wire barrel portion of the contact is the most compressed area and is most critical in ensuring optimum electrical and mechanical performance of the crimped contact. The crimp must be centered on the closed wire barrel. The crimp must result in a 2D crimp. Voids between the two halves of the wire barrel crimp are acceptable. See Figure 3. The crimp height and width must be within the dimensions given in Figure 4 for both the front and rear wire barrel crimp. The strands may be in 1 or 2 groups. Contact TE Connectivity product information center for double wire crimping requirements.

#### C. Insulation Barrel Crimp

The overlap crimp applied to the insulation barrel of the contact must result in an overlap crimp where the legs of the insulation barrel wrap firmly around the wire insulation without cutting into the wire insulation. This forms an asymmetric overlap crimp due to the different insulation barrel leg lengths. The crimp width dimensions are provided in Figure 3.

#### D. Twist and Roll

There should be no twist or roll of the wire barrel or mating portion of the crimped contact that would cause overstress or impair usage. See Figure 3 for allowable limits.

#### E. Wire End Extrusion Length (Brush)

The wire conductor ends must extend beyond the end of the wire barrel within the dimensions of .38mm [.015"] and 1.14mm [.045"] given in Figure 3.

#### F. Bellmouths

The front bellmouth and rear bellmouth shall conform to the dimensions given in Figure 3.

#### G. Wire Location

Conductors must be held firmly inside the wire barrel; no strands are permitted outside of the wire barrel. The wire insulation must be inside the insulation barrel, but must not enter the wire barrel. The wire

conductors and insulation must be visible within the area between the wire barrel and insulation barrel as shown in Figure 3.

**H. Bend Allowance**

Then bend allowance between the wire barrel and cable is acceptable within the limits given in Figure 3.

**I. Wire Barrel Flash**

Wire barrel flash is the formation that may appear on one or both sides of the wire barrel as the result of the crimping process. It must not exceed 0.13 [.005"] (maximum) when crimping product on strip with an applicator or 0.30 [.012"] (maximum) when crimping loose piece product with a hand tool.

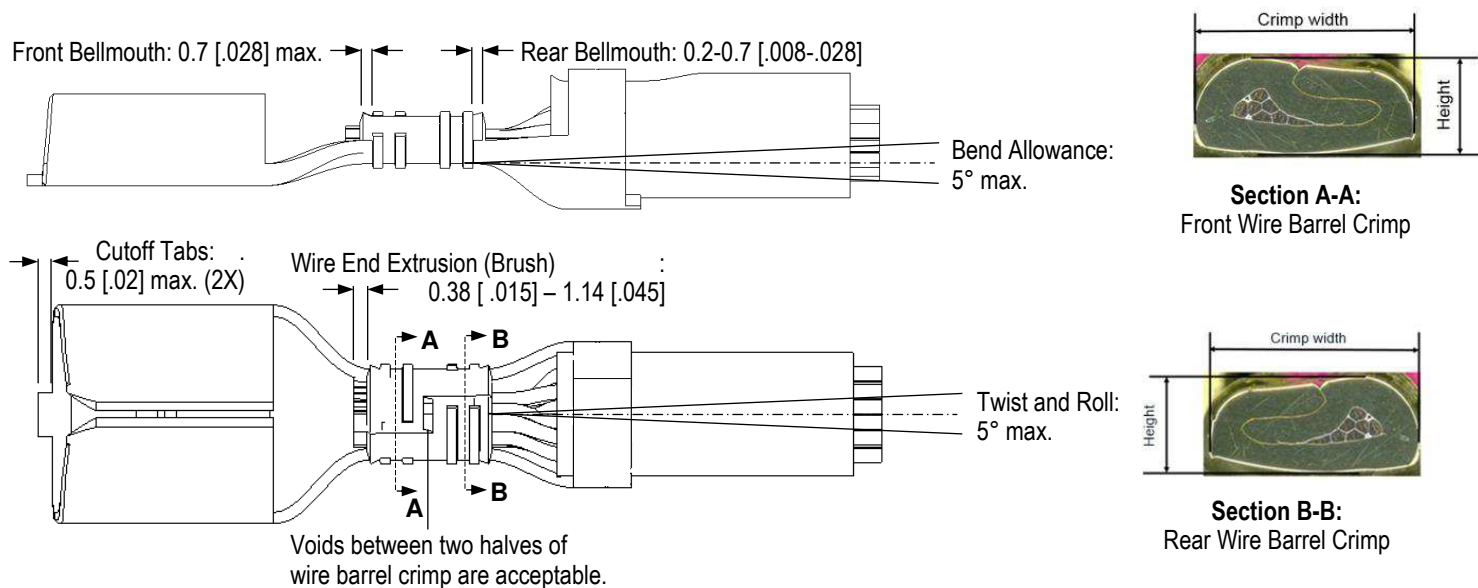

**Figure 3**

Series	Part Number	Applicator	Wire			Wire Barrel Crimp		Insulation Barrel Crimp
			No. of Wires	Wire Circular Mil Area (CMA)	Ref. Wire Size (mm <sup>2</sup> [AWG])	Width (Ref.)	Height	Width (Ref.)
6.3 [.250]	2238173-3	2150831-2	1	700	0.32 [22]	3.3 [.130]	1.17±0.05 [.046±.002]	4.06 [.160]
			1	1000	0.52 [20]		1.22±0.05 [.048±.002]	
			1	1600	0.82 [18]		1.30±0.05 [.051±.002]	
			1	2600	1.3 [16]		1.45±0.05 [.057±.002]	
			1	4100	2.1 [14]		1.65±0.05 [.065±.002]	
			1	6500	3.3 [12]		1.98±0.05 [.078±.002]	
4.8 [.187]	2238174-3	2150832-2	1	400	0.2 [24]	2.79 [.110]	1.02±0.05 [.040±.002]	3.81 [.150]
			1	700	0.32 [22]		1.07±0.05 [.042±.002]	
			1	1000	0.52 [20]		1.12±0.05 [.044±.002]	
			1	1600	0.82 [18]		1.22±0.05 [.048±.002]	
			1	2600	1.3 [16]		1.37±0.05 [.054±.002]	
			1	4100	2.1 [14]		1.57±0.05 [.062±.002]	

Figure 4

### 3.5. Mating Tab

Mating tab dimensions must correspond with UL310 requirements and include a dimple or hole. Mating tab dimensions must be within dimensions given in Figure 5.

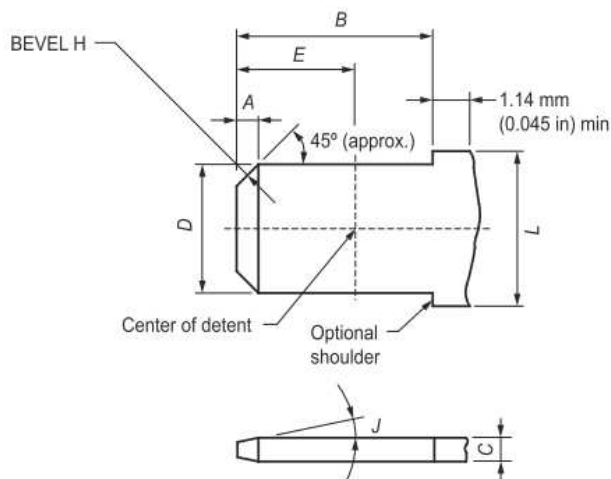

Nominal Size	Feature						
	A	B (min)	C	D	E	F	J
6.3 x 0.8 [.250 x .032] with dimple	0.7-1.0 [.027-.040]	7.8 [.307]	0.77-0.84 [.030-.033]	6.20-6.40 [.244-.253]	3.6-4.1 [.142-.161]	1.6-2.0 [.063-.080]	8°-12°
4.8 x 0.8 [.187 x .032] with dimple	0.7-1.0 [.027-.040]	6.2 [.244]	0.77-0.84 [.030-.033]	4.60-4.80 [.181-.190]	2.3-2.8 [.091-.110]	1.3-1.5 [.050-.060]	8°-12°

Figure 5

### 3.6. Inspecting

#### 3.6.1 Crimp Height:

Tangency Crimp Height (within figure 4 ranges) is measured (after removal of any flash with a file) across Section A-A and Section B-B (see Figure 3) for set up. These should be audited periodically (as on F-crimping) and may be done with one section A-A or B-B. The wire barrel crimp geometry should produce the same crimp height across both Section A-A and Section B-B (within .0020" [.05 mm] of each other); unequal crimp height may indicate damage to the crimper tooling, flash, or inaccurate set-up. When confirming crimp height repeatability with CpK, use the same cross-section (A-A or B-B) for all the readings of the study.

Serrations on the 2D Terminal Crimp are visible from the outside of the crimp wire barrel, as on F-crimps. This enables easier identification of the correct clamping and cutting locations. See Figure 7. Cross-sectioning for wire barrel crimp evaluation should be between these serrations. The cross-section acceptance criteria defines the reduction in wire cross-sectional area within the 10-30% range with respect to the measured CMA of the uncrimped wire, as on an F-crimp.

Notes - It is expected that due to the width of the measurement blades, this mechanical measurement is over top of the serrations visible on the outside of the wire crimp barrel.

- These measured crimp height per the crimp height charts (with the terminal rolling to the tangency on the top and bottom radius) will have lower crimp height values (about .004 - .006" [0.10 – 0.15 mm] less) than cross-sectioned crimp height measurement when clamped square as in a Crimp Validation Report (Crimp VR).

#### Blade Micrometers (Preferred Accuracy)



#### Calipers (Acceptable)

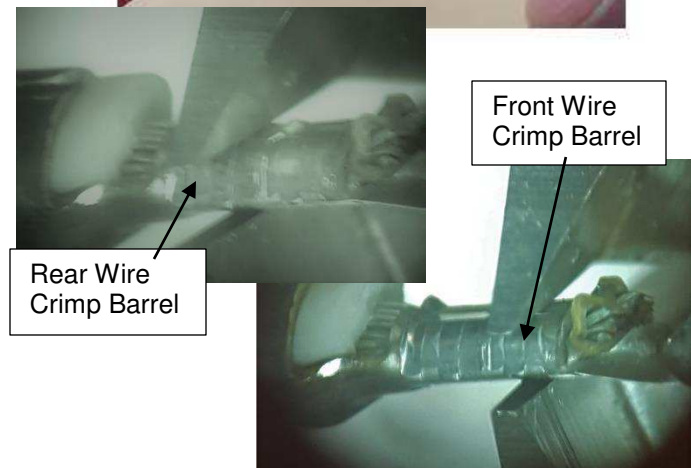

Figure 6

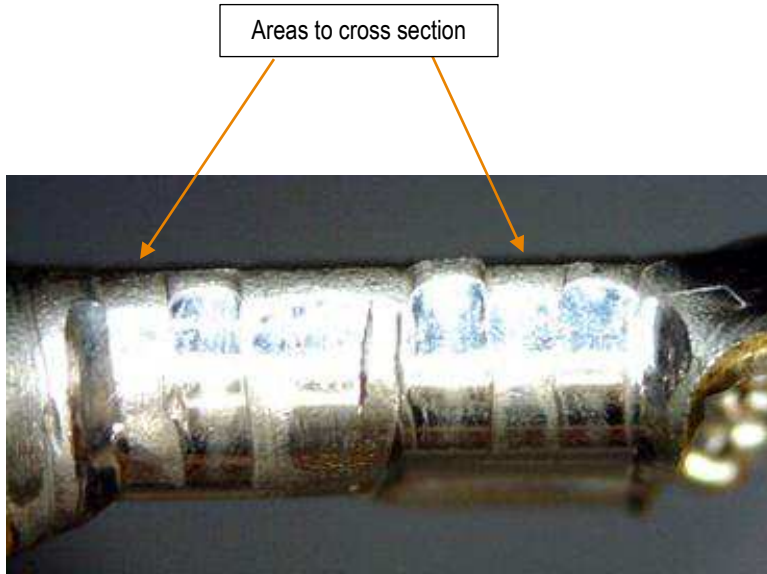

Figure 7

**3.6.2 Crimp-to-Wire Tensile Pull-out Test:**

These terminals have an integral insulation barrel crimp. For this test, this secondary insulation barrel crimp should either A) not be closed, or B) should be “rendered mechanically inactive or removed”.

A representative terminal shall be subjected to a tensile force as a destructive validation test. If the load is applied by a tensile testing machine, the rate of loading shall be 25.4 mm/min [ 1 in/min.]. If dead weights are used, the load is to be applied gradually without sudden jerks or movement and held for a period of 1 minute. The crimp to wire bond must stay together up to the force as specified in Figure 8 (below).

This test is validating the wire to terminal crimp bond integrity. Damage to the terminal, other than separation of the terminal wire barrel from the wire at below the specified force, shall NOT be considered a failure. Fixturing to evenly transfer the load into the terminal and/or crimp barrels may be used.

Wire Range (CMA [AWG])	Min. Tensile Force ( N [ lbs. ] )
400 [24]	22 [5]
700 [22]	36 [8]
1000 [20]	58 [13]
1600 [18]	89 [20]
2600 [16]	133 [30]
4100 [14]	222 [50]
6500 [12]	311 [70]

Figure 8

**3.7. Replacement and Repair**

Damaged or defective product must not be used. Any defective receptacles should be removed and replaced with an undamaged terminal. The receptacle contacts are not repairable once termination has been made.



## 4. QUALIFICATION

### 4.1. Internal TE Qualification

Qualified with testing according to TE Product Specification [108-143087](#).

### 4.2. Underwriters Laboratories Inc. (UL)

These terminals are Listed by Underwriters Laboratories Inc. (UL) under UL 310.

## 5. TOOLING

Tooling part numbers and instructional material packaged with the tooling are given in Figure and Figure .

### 5.1. Machine (Power Unit)

The machine provides the force required to drive an applicator for crimping the contacts. These machines can be set up to be automatically measure, cut, strip, and terminate the wire. Benchtop presses or lead makers with appropriate ocean applicators are recommended for crimp termination.

The applicators accept interchangeable die assemblies and must be installed onto a power unit. See Figure 9.

Series	Applicator Part Number
6.3 [.250]	2150831-2
4.8 [.187]	2150832-2

Figure 9

### 5.2. Applicator

The applicators are designed to crimp strip-mounted contacts onto pre-stripped wire. Applicator conversion kit part numbers are listed in Figure 10.

Series	Applicator Conversion Kit Part Number	Convert From
6.3 [.250]	7-2150831-8	2150016-X
	7-2150831-9	2150640-X
4.8 [.187]	7-2150832-8	2150007-X
	7-2150832-9	2150312-X

Figure 10



## A) Assemble the Anvil into the Applicator.

## B) Assemble the crimper stack:

- 1) Front Wire Barrel Crimper (Higher “hump” to your Right)  
Note – The holes in these crimper legs are threaded.



- 2) Rear Wire Barrel Crimper (Higher “hump” to your Left)  
Note – The holes in these crimper legs are clearance holes.



Note - “Two reference holes” in the wire crimpers, the holes do NOT line up. ( i.e. – they are staggered opposite).



Note - Newer “One reference hole” crimpers, the holes line up at upper left.



- 3) Assemble Wire Depressors and Crimper Spacers as defined in the Applicator drawing.
- 4) Insulation Barrel Crimper Overlap Crimper is assembled with PN facing out toward operator.



Smaller  
OD Wires

Note – The insulation barrel is formed to overlap on the smaller wire sizes using the “Overlap” crimper on these terminals, but the “wings” may reach as little as 270 degrees around the wire circumference on the larger wire sizes.

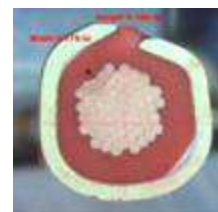

Larger  
OD Wire

- 5) Assemble Center screw to Ram with bushing and washer. (Leave Loose).
- 6) Assemble the 2 socket head cap screws into the crimper legs (Leave Loose.)
- 7) With a piece of paper over the anvil, gently jog the ram down until the crimpers straddle the anvil and trap the paper. (This aligns the 3 crimpers with the anvil.)
- 8) Tighten the Center Screw to the Ram.
- 9) Jog the ram up from the anvil.
- 10) Tighten the 2 socket head cap screws in the crimper legs.
- 11) Set your wire barrel crimp height. Set the insulation barrel crimp height high.
- 12) Cycle a terminal with wire. (This may be cycled slowly to verify proper tool settings.)
- 13) Verify the back wire barrel crimp height, and verify the “front” and “back” wire barrel crimp heights are both within the  $\pm 0.002$  [0.05mm] of nominal (ideally, these crimpers are also within  $\pm 0.001$  [0.025mm] of each other too).
- 14) Verify wire pull strength.
- 15) Then close down the insulation barrel crimp height until the wire insulation is properly compressed.
- 16) The applicator should be ready to run.

**Addendum A:**

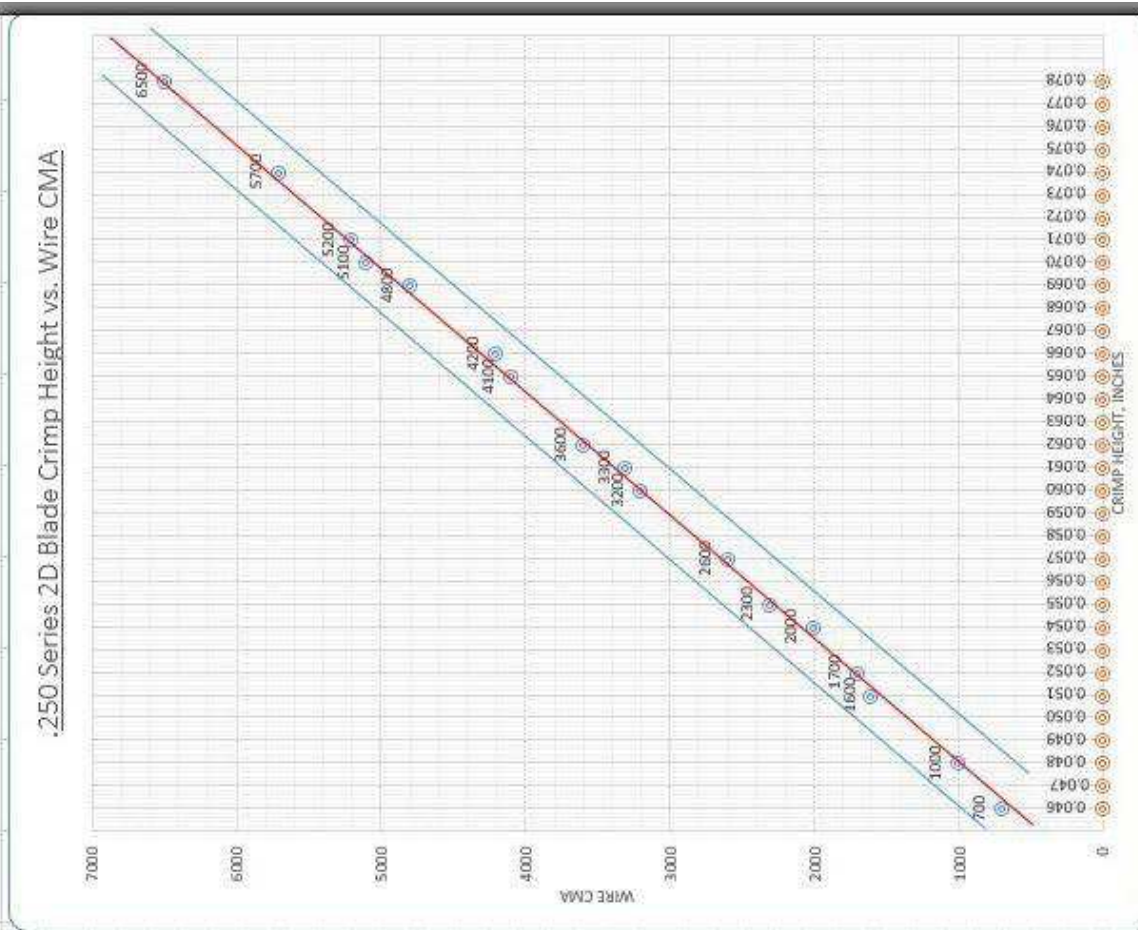

**Blade Crimp Heights For 2D .250 Series**

**PNs 2238171-3 & 2238173-3**

Blade	Wire Size		Blade	
	AWG)	CMA	Crimp Height Inches	Crimp Height mm
x	22	700	0.046	1.17
x	20	1000	0.047	1.19
x	18	1600	0.048	1.22
	(1)22+(1)20	1700	0.049	1.24
	(2)20	2000	0.050	1.27
	(1)22+(1)18	2300	0.051	1.30
	16	2600	0.052	1.32
	(1)20+(1)16	3600	0.053	1.35
	(1)20+(1)18	3200	0.054	1.37
	(1)22+(1)16	3300	0.055	1.40
	(1)20+(1)16	3600	0.056	1.42
	14	4100	0.057	1.45
	(1)18+(1)16	4200	0.058	1.47
	(1)22+(1)14	4800	0.059	1.50
	(1)20+(1)14	5100	0.060	1.52
	(2)16	5200	0.061	1.55
	(1)18+(1)14	5700	0.062	1.57
	(1)18+(1)14	5700	0.063	1.60
	(1)18+(1)14	5700	0.064	1.63
	(1)18+(1)14	5700	0.065	1.65
	(1)18+(1)14	5700	0.066	1.68
	(1)18+(1)14	5700	0.067	1.70
	(1)18+(1)14	5700	0.068	1.73
	(1)18+(1)14	5700	0.069	1.75
	(1)18+(1)14	5700	0.070	1.78
	(1)18+(1)14	5700	0.071	1.80
	(1)18+(1)14	5700	0.072	1.83
	(1)18+(1)14	5700	0.073	1.85
	(1)18+(1)14	5700	0.074	1.88
	(1)18+(1)14	5700	0.075	1.91
	(1)18+(1)14	5700	0.076	1.93
	(1)18+(1)14	5700	0.077	1.96
x	12	6500	0.078	1.98

x - Measures .004" lower than with crimp micrometer and fixture adapter.  
 CMA is control for crimp height.  
 AWG sizes are for reference only.

**Addendum B:**

**Blade Crimp Heights For 2D .187 Series  
PNs 2238172-3 & 2238174-3**

Blade	Wire Size		Blade	
	AWG)	CMA	Crimp Height Inches	Crimp Height mm
x	24	400	0.039	0.99
x	22	700	0.041	1.02
x	(2)24	800	0.042	1.04
	20	1000	0.043	1.07
	(1)24+(1)22	1100	0.044	1.09
		1400	0.045	1.12
		1600	0.046	1.14
	(2)22 or (1)24+(1)20	1700	0.047	1.17
x	18	2000	0.048	1.22
	(1)22+(1)20	2300	0.049	1.24
	(2)20 or (1)24+(1)18	2600	0.050	1.27
	(1)22+(1)18	3000	0.051	1.30
		3200	0.052	1.32
		3600	0.053	1.35
x	16 or (1)20+(1)18	4000	0.054	1.37
		4500	0.055	1.40
	(1)24+(1)16	5000	0.056	1.42
	(2)18	5500	0.057	1.45
	(1)22+(1)16	6000	0.058	1.47
	(1)20+(1)16	6500	0.059	1.50
		7000	0.060	1.52
		7500	0.061	1.55
x	14	8000	0.062	1.57

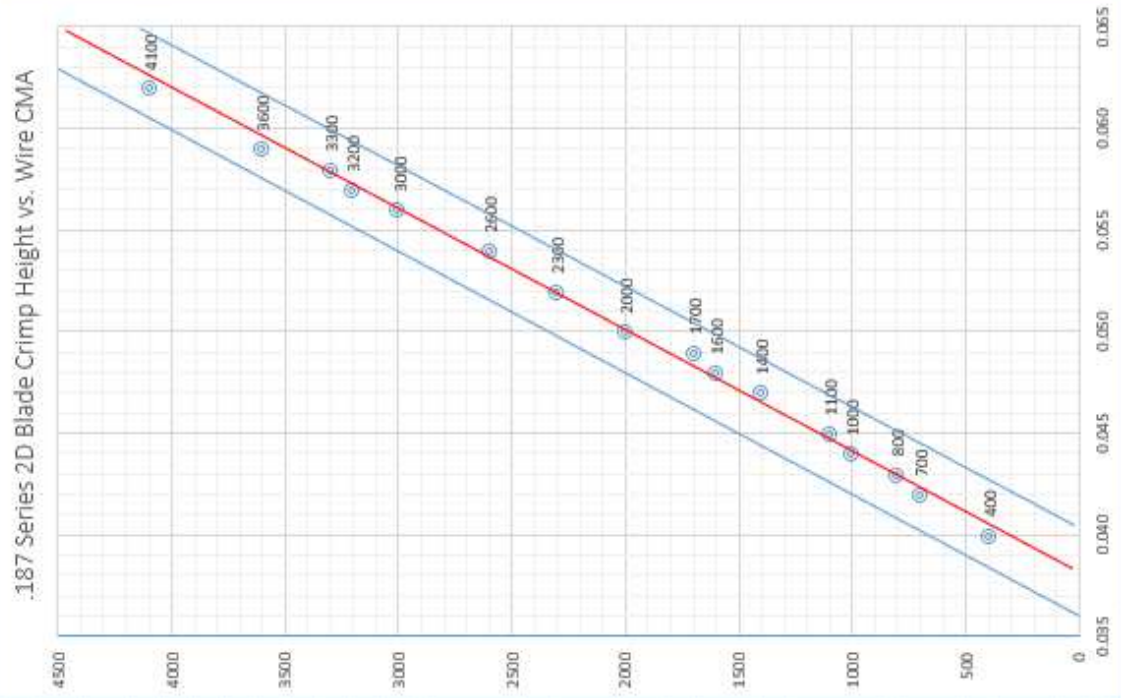

x - Measures .004" lower than with crimp micrometer and fixture adapter.  
CMA is control for crimp height.  
AWG sizes are for reference only.

**Addendum C:**

**How to Compute “Circular Mil Area” (CMA) on Stranded Wire with Round Strands:**

Stranded wire CMA is calculated in the following way for wire with circular wire strands:

- 1) Each strand diameter is measured in inches to 4 decimal place accuracy (or tighter) and recorded. This gives a reading to the ten-thousandths of an inch. (e.g.- AWG 40 strand may be .0098 to .0102”)
- 2) This reading is then converted to “Mils” by multiplying by 1000. For example .0100” would be 10.0 mils.
- 3) This reading for each strand is squared. (e.g.  $10.0^2 = 100$  CMA)
- 4) For a stranded wire, the CMA of each of these strands is added-up for a total CMA. This is typically rounded to the nearest whole number.

**Example: For a 7-strand wire this could be:**

Strand #	Measured Dia. (In.)	Diameter (Mils)	Strand CMA
1	.0100	10.0	100.00
2	.0098	9.8	96.04
3	.0098	9.8	96.04
4	.0101	10.1	102.01
5	.0100	10.0	100.00
6	.0102	10.2	104.04
7	.0100	10.0	+100.00

Total CMA = 698.13

**ANSWER: Rounded to the nearest whole # = **698 CMA****

(Reference: AWG 22 wire is nominally 700 CMA)

Definitions:

“CMA” = Circular Mil Area is an industry accepted measure of the total wire cross-sectional size.

“MIL” = Thousandths of an inch (i.e. .0100 inches = 10.0 mils)



## Addendum D - .250 Series Straight FASTON 2D Crimps:

### Typical Wire Barrel and Insulation Barrel PN 2238173-3 Crimp Forms vs. Wire Size

Crimp Contact Name:		2D	Operator:		M. Yecker
Terminal Part Number:		2238173-3			
Applicator Number:		2150831-2			2/14/2020
Terminal Manufacturer:		TE Connectivity			
Typical Wire Barrel	Imm. Wire Size REF AWG CMA	Typ. Ins.	Typical Insulation Barrel	Typical Top View of Crimped Terminal	
	AWG 22 700	2.34mm [.092"]			
	AWG 20 1000	2.52mm [0.099"]			
	AWG 18 1600	2.76mm [.109"]			
	AWG 16 2600	3.08mm [.121"]			
	AWG 14 4100	3.46mm [.136"]			
	AWG 12 6500	3.94mm [.155"]			

**Addendum E - .187 Series Straight FASTON 2D Crimps:**

**Typical Wire Barrel and Insulation Barrel PN 2238174-3 Crimp Forms vs. Wire Size**

Crimp Contact Name:	2D	Operator:	M. Yecker
Terminal Part Number:	2238174-3		
Applicator Number:	2150332-2		2/14/2020
Terminal Manufacturer:	TE Connectivity		

Typical Wire Barrel	Num. Wire		Typ. Ins.	Typical Insulation Barrel	Typical Top View of Crimped Terminal
	REF	GM			
	AWG 24	400	2.19 mm [.086"]		
	AWG 22	700	2.34mm [.092"]		
	AWG 20	1000	2.52mm [0.099"]		
	AWG 18	1600	2.76mm [.109"]		
	AWG 16	2600	3.08mm [.121"]		
	AWG 14	4100	3.46mm [.136"]		



# 2D CRIMP Quality Guidelines

### GOOD 2D CRIMP

SECTION X-X  
12 AWG

22 AWG      16 AWG      12 AWG

GOOD WIRE BARREL CRIMP CROSS SECTION

GOOD INSULATION BARREL CRIMP CROSS SECTION

INSULATION CRIMP BEND TEST

### MEASURING 2D CRIMP

Blade Micrometers (Preferred Accuracy)

Calipers (Acceptable)

### BAD 2D CRIMP

BEND TERMINAL

BAD WIRE BARREL CRIMP CROSS SECTION

TWIST TERMINAL

BAD INSULATION BARREL CRIMP CROSS SECTION

INSULATION BARREL DISTORTED

BAD INSULATION BARREL CRIMP CROSS SECTION